

- Transformer fails on any High voltage tests.
- Transformer is proved to have been manufactured not in accordance with the agreed specification.
- The Owner reserves the right to retain the rejected transformer and take it into service until the Vendor replaces, at no extra cost to Owner, the defective transformer by a new acceptable transformer.
- Alternatively, Vendor shall repair or replace the transformer within a reasonable period to the Owner's satisfaction at no extra cost to the Owner.
- Also, Owner shall repair or replace the transformer in case of transformer failure within five (5) years from date of commissioning, due to any reason including, but not limited to high inrush current, harmonics, switching over-voltages.

#### **4 LT SWITCHGEAR**

- a. LT switchgear shall be suitable to house following components:
  - MCCB/ACB for incoming/outgoing feeder with microprocessor based over current, short circuit and earth fault release.
- b. Bus bar:
  - PVC sleeved Aluminium busbars.
  - Bus bar shall be of high conductivity aluminium supported on insulators made of non-hygroscopic, non-inflammable material with tracking index equal to or more than that defined in BIS. The main bus bars shall have uniform current ratings throughout their length. The current rating of the neutral shall be half that of the phase bus bars. Removable neutral links shall be provided on feeders to permit isolation of the neutral bus bar.
  - Only zinc passivated or cadmium plated high tensile strength steel bolts, nuts and double spring washers shall be used for all bus bar, joints and supports.
  - The hot spot temperature of bus bars including joints at design ambient temperature shall not exceed 95°C for normal operating conditions.
  - The current rating of the bus bars shall be as required for design ambient temperature at site conditions and for being inside the cubicle at fully loaded condition. The Vendor shall suitably de-rate the nominal rating to suit the above condition.
  - Interconnections between the main bus bars and individual units shall be made using vertical / horizontal aluminium bus bars of adequate rating.

### c. TESTS FOR CSS

- Enclosure shall be type tested for Ingress protection on each compartment.
- It is mandatory to have temperature rise test on enclosure for K10 class.
- Compact Substation Enclosure and HT switchgear shall be type tested for IAC 25 kA / 1 sec.
- Type test reports for enclosure, switchgears, Circuit Breakers shall be furnished along with the tender and subsequently.
- The switchgear, circuit breakers and all associated equipment shall be tested in accordance with relevant standards. All routine tests shall be carried out. Type tests shall also be carried out if not tested previously.
- Type and routine test report shall be submitted for the Owner's approval before the equipment is dispatched. Bound copies of test reports shall be furnished along with the switchgear.
- All meters and other reference devices used for testing shall have valid calibration from reputed national laboratories/institutes. Inspection by Owner/ Engineer will not be carried out unless the Vendor confirms that calibrated equipment is ready for proceeding with the tests.
- Equipment shall not be dispatched unless the test certificates are duly approved by the Owner/ Engineer-in-charge.
- All type test shall be from third party witnessed from NABL accredited lab.

## 5 LT PANELS

### 5.1 SCOPE

- a. The Scope of 415 V LT Panels include Design, engineering and manufacturing; testing at manufacturer's works, packing, forwarding and delivery to site; unloading and handling (shifting from unloading point to the storage area, storage and shifting from the place of storage to the place of installation) at site, assembly, erection, cleaning & touch up painting, testing, commissioning and performance demonstration at site of various ratings as per requirement.

### 5.2 GENERAL

- a. LT panel shall be (tested assembly - TTA) CPRI/Independent international test house tested for all the tests as per IS/IEC61439-1 & 2 and internal arc tests as per IEC 61641 V3, 25kA for 0.5 sec minimum at Horizontal bus bar, veridical bus bar and cable chamber.
- b. LT Panel shall also be tested of design as per Seismic Zone Vol IEC 60068-3-3.

- c. Panel shall be rated for Impulse withstand capability equal to or greater than the switchgears inside the panel.
- d. The metal enclosed switchgear shall be designed to operate continuously with reference of ambient temperature of 45°C without any de-ration.
- e. The equipment shall be designed and manufactured in accordance with the best engineering practice and shall be such that has been proved to be suitable for the intended purpose.
- f. Provision for interlocking of LV Incomer breaker with HV side breaker shall be provided such that if the HV breaker trips then the LV breaker will trip and it shall not be possible to close the LV breaker unless the HV side breaker is closed.
- g. The Panel shall be indoor type having incoming, sectionalisation, outgoing switchgears etc. as per requirement. The design shall be cubical type. The degree of enclosure protection shall be IP 52 for indoor up to 2000A rating and IP42 above 2000A rating and IP55 for outdoor as per IS: 13947 (Part-I).
- h. All panels shall be from same manufacturer.
- i. LV panel's manufacturer must have experience of manufacturing, supply and installation of LV panels of TTA or IS/IEC 61439 design for past 05 years as a qualifying requirement.

### **5.3 CONSTRUCTIONAL REQUIREMENTS**

- a. All panel boards shall be free standing, metal enclosed, single front, fabricated with 2mm CRCA sheet steel for all doors, partitions and covers and 2 mm CRCA sheet steel for load bearing sections including all ACB feeders. A base channel of 75 mm x 40 mm x 5 mm thick shall be provided at the bottom for floor mounted panels.
- b. The gasket shall be suitable to withstand all weathers for long tenure of service. All hardware shall be HD Galvanized or stainless steel.
- c. PCC, APFC, DG panels shall conform to FORM 4B as per IS/IEC 61439 and metering, common services, street lighting panels shall conform to FORM 3B as per IS/IEC 61439.
- d. For operator safety IP2X (touch proof) protection to be available even after opening the feeder compartment door. The compartmentalization to be achieved by using metal separators.
- e. Each door & cover shall have adequate reinforcement of suitable ribs & stiffeners. All feeders and cable alleys shall have hinged type door with panel locks. All bus-bar covers and other panel covers shall be screw fixed. Cable alleys and bus-bar chamber shall have minimum width of 300mm.

- f. All doors shall be with concealed type hinges and captive screws. Rear doors of panels requiring rear access shall be provided with removable hinged doors. Side covers of panels shall be with removable panels.
- g. All doors shall be provided with durable and easy fitting locks with special keys to ensure opening by authorized personnel. Rubber grommets shall be provided at the cable entry.
- h. All mounting accessories like base channels, cross angles if required, nuts, bolts etc. shall be supplied by the Vendor.
- i. All the panels shall have uniform height. The operating height of all the panels shall not be less than 300mm and not more than 1800mm. Panel height should not be more than 2450mm.
- j. All the panel boards shall have cable entry from top/bottom as per requirement. Split gland plate of 2mm thick shall be supplied for termination of power, control and instrumentation cables sized as per the required no. of cable and 20% spare space for future addition.

#### **5.4 BUS-BARS**

- a. Bus-bar of the panels shall be rated for Continuous current at site conditions.
- b. All bus-bars shall be electrolytic grade copper or aluminium. Bidder shall specify the purity and conductivity of the bus bar along with the Bid.
- c. All the bus bars shall be sleeved with heat shrinkable black colour PVC sleeve or better insulation with coloured polyester tapes for phase identification at regular intervals/ locations.
- d. Bidder shall submit all calculations & documental proof of the adequacy of the bus bar sizes to meet the continuous and short time current ratings.
- e. Vertical bus-bars shall have S.C. rating same as main bus bar and shall be suitable for all connected load of vertical section.
- f. Bidder shall ensure that incoming feeder shall be suitably designed for terminating the required no. of runs of 1.1kV grade XLPE insulated armoured cables with 20% spare capacity. Bidder shall consider the necessary arrangement (dummy panel, adapter panel, rear extension etc.) if required, for terminating the cables within the limits specified above.
- g. The bus-bars shall be designed considering the following criteria:
  - Current density of 0.8A/sq. mm maximum for aluminium and 1.2A/sq. mm for copper.
  - Sleeves made of insulating material on all bus bars.

- Bus bars carrying rated current continuously at Design Ambient Temperature shall be considered as 45°C and temperature rise shall be considered as per latest relevant standard.
  - Configuration of bus bars, Skin and Proximity effect
  - Bus bars shall withstand the short time rating of the panel.
- h. The span between the two insulators shall be as per the approved TYPE TEST REPORT for short time rating. Joint positions and insulators shall be properly adjusted so that they don't interfere. Bus bar bending shall be carried out on appropriate machines designated for the same rather than doing manually.
  - i. Neutral bus-bars of the panel boards shall be rated equal to the size of phase bus and shall be in same chamber with phase bus bar.
  - j. All bus-bar shall be treated with anti-oxide paste wherever bi-metallic contact is required.
  - k. The material and spacing of the busbar support should be same as per the type tested assembly.

## **5.5 EARTHING**

- a. Earth bus bars of Aluminium/Copper material shall be run all along the panel, extended out at both ends of value equal to the rated symmetrical short circuit rating of the associated switchboard/ panel. The same shall be properly supported to withstand stresses induced by the rated symmetrical short circuit current.
- b. Earthing bus-bar shall be terminated at both ends of the switchgear to suit the connections to earthing conductor. The locations where the bus is protruding out of the panel boards, Contractor shall ensure that proper ingress protections are provided at all such locations.
- c. All doors and detachable components inside the feeder are required to be earthed individually with green (with yellow band) colour PVC insulated multi-stranded copper conductor wire of size 4 sq.mm duly crimped with ring type lugs and are to be looped & connected to horizontal earth bus.
- d. Earthing bus shall run continuously in panel drawn out suitably considering respective cable entry inside the panel.
- e. Al/Cu earth bus shall be provided at each cable alley for all the panels.

## **5.6 POWER WIRING (INSIDE THE FEEDER)**

- a. All power wiring for rating upto and including 63A shall be carried out with 1.1kV grade coloured FRLS PVC insulated, coloured for phase identification, multi stranded copper wires duly crimped with ring type lugs.

## **5.7 CONTROL WIRING (FOR PANEL AND FEEDERS)**

- a. All panel Control wiring shall be done by 1.1kV grade FRLS PVC insulated multi-stranded copper wire. CT circuit wiring shall be done with minimum 2.5 Sq.mm size wire of above specification. Control and Potential circuits shall be wired with minimum 1.5 sq. mm size wires of above specifications. Wires shall be grey coloured with suitable crimp able copper lugs. CT's & PT's wiring shall be colour coded for multi-phase identifications (R-Y-B-N).

## **5.8 GENERAL REQUIREMENTS**

- a. DP MCB shall be provided for all control circuits where the fault level is less than 10kA. Else the control supply shall be tapped through a control transformer of adequate capacity supplied with MCCB/ MPCB of adequate short time rating. Independent DP MCBs shall be provided for each circuit such that tripping due to fault in one circuit should not affect other functions adversely.
- b. Self-explanatory Wiring diagrams with terminal and wire numbers, component numbers shall be provided on the inner face of the door of each feeder. Drawing set in the panel shall be laminated.
- c. All labels for identification of feeders as well as internal and external components as per legends provided by Owner shall be on white acrylic sheet with black engraving. These labels shall be fixed by screws/rivets and shall not be pasted.
- d. Aluminium etched 415V Caution boards written in three languages (English, Hindi, Local) shall be riveted on the panel at locations where live bus bars are present and need isolation before any access to it. In case secondary covers have been provided inside the panel, then caution boards shall be also marked on these boards in addition to the external covers. Stickers are not acceptable.
- e. Selector/control switches shall have an 'Off' position. The 'Off' position shall not be wired in any circuit and shall be utilized to disconnect (or bypass) power supply to control circuit for any maintenance work.
- f. All electrical panels (internal components & arrangement) shall have finger touch protection, for human safety viz. working on one component shall not cause shock to the personnel due to any other live component in the panel. Also, the terminal live parts shall not be accessible by fingers (finger cannot come in contact with live parts of the terminals).
- g. No openings/ holes meant for fixing hardware shall be left open. All the hardware (esp. screws, nuts, bolts, and washers) shall be in all appropriate positions & properly tightened.
- h. Phase separators, shrouds, falling tool barriers shall be suitably provided. Any additional requirements as observed at any stage upto handing-over shall be

provided (for safety and ease of maintenance) without any cost implication to the Owner.

- i. All PVC/engineering plastic-based items (including but not limited to conduits, casing-capping, trough, trunk, enclosures, covers, plugs, etc.) shall be with FR properties.
- j. Lifting hooks/eyes shall be provided in each shipping section of the equipment and shall be removable type. The equipment shall be given tropical and fungicidal treatment.
- k. Insulation mat of suitable standard width shall be provided in front of the HV and LV panels.
- l. At least one 230V, 1Ph, Space heater shall be provided for each vertical section of the switchboard. Each Space heater shall be provided with an isolating switch, a thermostat and dedicated MCB protection of appropriate rating. Heater shall be mounted at bottom of the panel with cover to avoid accidental contact of heater with skin.
- m. 230V 1Ph, Panel illumination (11W LED fixture with lamp, limit switch and isolation switch) along with 1 no. 5/15A, 5 pin socket with switch shall be provided for each vertical section. Bare holder with open lamp is not acceptable.
- n. Adequate space shall be provided for terminating the outgoing cables.
- o. Control transformer of adequate KVA rating with Changeover facilities shall be provide in the panel.

## **5.9 EQUIPMENT REQUIREMENT**

- a. MCCB
  - All the panels shall have MCCBs upto 630Amp. All MCCBs shall be rated for 415V, 3 Ph, 50Hz, 25KA (Minimum).
  - MCCBs in AC circuits shall be of triple/four pole construction arranged for simultaneous three/four pole manual closing and opening. Operating mechanism shall be quick-make, quick-break and trip-free type. The ON, OFF and TRIP positions of the MCCB shall be clearly indicated and visible to the operator. All MCCBs shall be provided with rotary operating handle with door interlock feature.
  - The instantaneous short circuit release shall be so chosen by the Vendor as to operate at a current in excess of the peak motor inrush current and a range of settings shall be provided for the Owner's selection.
  - MCCB terminals shall be shrouded and designed to receive cable lugs for cable sizes relevant to circuit ratings.

- All MCCB feeders shall be provided with ON/OFF/TRIP indicating lamps through auxiliary contacts.
- All MCCB's shall be with  $I_{cu}=I_{cs}=100\%$ .
- All MCCBs shall be provided with 2 NO + 2 NC aux. contacts exclusively for Owner's use.
- All the MCCBs shall be of current limiting type and shall provide a cut off in, < 10 ms for prospective currents during faults.
- The MCCB's shall be provided with microprocessor-based overload, short circuit and earth fault releases. For four pole MCCB, the microprocessor-based earth fault release shall be inbuilt.
- For TPN MCCB the microprocessor-based earth fault release shall be inbuilt with a separate neutral CT input or the earth fault protection shall be provided by CBCT, ELR and shunt trip coil.

b. ACB

- From 630 A onwards ACBs shall be used. These should have 25 kA ( $I_{cu}=I_{cs}=I_{cw}=100\%$ ). Circuit breakers shall be provided with following accessories:
- Mechanically operated targets to show 'Open', 'Closed', 'Service' and 'Test' positions of the circuit breaker. Padlock devices shall be provided in order to control opening/closing and racking in/out of the circuit breaker.
- Mechanically operated, red 'trip' push button, shrouded to prevent accidental operation. Circuit breaker main contacts should be separate from arcing contacts.
- Locking facilities in the 'Service', 'Test', and 'Isolated', positions. In test position the breaker will be tested without energizing the power circuits. The breaker shall remain fully housed inside the compartment in the test position. Complete operation of the circuit breaker and trip unit must be accessible without opening the circuit breaker door.
- Minimum 6 NO and 6 NC potential free auxiliary contacts, rated 10 A at 240V AC and 1A inductive breaking at 220 V DC.
- Following indicating lamps for ACBs shall be considered:
  - i. On
  - ii. Off
  - iii. Trip
  - iv. Test Position
  - v. Service Position
  - vi. Spring Charged
  - vii. Trip Circuit healthy



viii. Control Supply Healthy

- R, Y, B indication lamps, Lamp test push button, and Emergency trip push button shall be considered at incomers.
- Trip shall be independent of local/remote. Emergency trip push button shall be mushroom type with lockable key
- Closing and trip coil shall operate satisfactorily under the following conditions of supply voltage variation:
  - i. Closing coils - 85% to 110% of rated voltage.
  - ii. Trip coils - 70% to 110% of rated voltage.
- When series trip circuit breakers are specified the following microprocessor releases with adjustable settings shall be provided:
  - i. Overload
  - ii. Short circuit
  - iii. Under voltage
  - iv. Earth fault
- For four pole breaker the microprocessor-based earth fault release shall be in built. For TPN breaker the microprocessor-based earth fault release shall be in built with input from a separate neutral CT.
- Facilities shall be provided for blocking the under-voltage release, if so required at Site.
- Each of the foregoing releases shall be provided with a single pole, double throw, potential free alarm contact rated for 0.5A, 220V D.C / 10A, 240V AC.
- The breakers controlling motors shall operate satisfactorily under following conditions:
  - i. Direct-on-line starting of the specified motor.
  - ii. Breaking no load current of the specified motor.
- Each incomer shall be provided with a Multi-Function Meter displaying all electrical parameters like (but not limited to) current, voltage, kW, kVA, kVAR, kWh, MD, PF, Hz, (THD measurement only in main PCC incomer) etc. and shall have provision for remote communication with SCADA.
- The switchgear shall be complete with all equipment such as CT, VT, switches etc. duly wired up to terminal blocks. Terminal blocks shall be located at suitable place for easy access. CT shorting, isolating terminals shall be provided for CTs and isolating terminals shall be provided for VT connections. Twenty (20) percent spare terminals shall be provided in each cubicle. Ring type lugs suitable for termination of 2.5 sq mm copper wires shall be used.

c. SPD

- The Internal Surge Protection Device shall be selected as per zone of protection described in IS/IEC 62305, 61643-11/12/21, 60364-4/5. Depending on Zone concept of provided in IS/IEC 62305 – 1 & 4.
- LPZ -OB & LPZ 1: At Mains entry point (Main LT Panel): Type 1 + 2, i.e. SPD Combined Arrester with Integrated Backup Fuse.
- LPZ1 & LPZ 2: Sub distribution panel will be used with Type 2 SPD i.e. SPD with integrated fuse - for each Sub Distribution Panel
- CCTV control room Panel + Server room Panel + IT building panel will be used with Type 2 SPD for each Panel.
- All data network will be protected using suitable Surge Protection Device.

## **6 APFC PANELS**

### **6.1 GENERAL**

- a. The equipment shall be complete with all necessary accessories and components as required as per IS standard.
- b. Supply, installation, Testing and Commissioning of automatic power factor improvement panel (indoor) with Capacitor Banks (APP Type), type test according to IS/IEC 61439-1&2, IEC 61921 including interconnection with LT panel with appropriate size of electric cable. The panel shall be indoor, factory fabricated, dust and vermin proof (IP42) type, suitable for 1100 V grade 3 phase 50 HZ AC supply, floor mounted in 12 stage (minimum two no. spare stage to be considered) controller with microprocessor-based relay along with fully ventilated both side opening.
- c. The capacitor banks shall be complete with all parts that are necessary or essential for efficient operation. Such parts shall be deemed to be within the scope of supply whether specifically mentioned or not.
- d. The capacitor bank may comprise of suitable number of single-phase units in series parallel combination. However, the number of parallel units in each of the series racks shall be such that failure of one unit shall not create an overvoltage on the units in parallel with it, which will result in the failure of the parallel units.
- e. The complete capacitor banks with its accessories shall be metal enclosed (in sheet steel cubicle), indoor floor mounting and free-standing type.
- f. All sheet steel work shall be thoroughly cleaned of rust, scale, oil, grease, dirt and swarf by pickling, emulsion cleaning etc. The sheet steel shall be phosphate and then painted with two coats of zinc rich primer paint. After application of primer, two coats of finishing synthetic enamel paint oven baked/stove shall be applied.

- g. The assembly of the banks shall be such that it provides sufficient ventilation for each unit. Necessary louvers may be provided in the cubicle to ensure proper ventilation.
- h. Each capacitor unit/bank shall be fitted with directly connected continuously rated, low loss discharge device to discharge the capacitors to reduce the voltage to 50 volts within one minute.
- i. All panels of capacitor banks with MCCBs, Contactor, minimum 12 stage automatic power factor correction relay enclosed in IP42 compliant CRCA Sheet Steel enclosure.
- j. Capacitors shall be APP type having following specifications and conform to IS 13925.
- k. The capacitors shall have Low Dielectric Loss of 0.5 W/ kVAR (maximum).
- l. All capacitors shall be provided with 7% de-tuned copper filter along with all accessories and protections.
- m. Any change in rated voltage level of the capacitor bank due to the filter or otherwise shall be considered by the Contractor.
- n. The banks shall be switched ON and OFF in both Auto as well as Manual mode. An "Auto/Manual" Switch at the incomer feeder shall be provided.
- o. All necessary auxiliary contactors of suitable duty along with feeder accessories are included in scope. All power Contactors for capacitor switching shall be of required duty.
- p. Manual operation shall be done with recess type panel mounted ON/OFF pushbutton with delay timer.
- q. Minimum current rating under site conditions, of circuit breakers, Contactors, and cables shall be at least 150% of rated capacitor current.
- r. Capacitors shall be mounted in such a way that heat dissipation is proper and the capacitors are accessible for maintenance and inspections.
- s. Capacitor switching and automatic power factor correction panel shall be designed in such a way that power factor of 0.99 lagging shall always be maintained. Timings to cut in capacitors shall be provided in such a manner to facilitate capacitor discharging before next switching and shall also avoid hunting due to temporary fluctuations of load. The timer shall be provided in both auto and manual mode.
- t. The Automatic power factor correction panel and capacitor panel are integral type, prewired including power connections. Due consideration shall be given for adding/ removal of capacitor or other components and maintenance considerations.

- u. Each unit shall satisfactorily operate at 130% of rated KVAR including factors of overvoltage, harmonic currents and manufacturing tolerance. The units shall be capable of continuously withstanding satisfactorily any overvoltage up to a maximum of 10% above the rated voltage, excluding transients.

## **6.2 UNIT PROTECTION**

- a. Each capacitor unit shall be individually protected by a MCCB Breaker suitably rated for load current and short circuit capacity, so that a faulty capacitor unit shall be disconnected by the breaker without causing the bank to be disconnected. Thus, the breaker shall disconnect only the faulty unit and shall leave the rest of the units undisturbed.
- b. The Inputs to the APFC system is Voltage input from two phases and current input from the third phase. Out of two phases of voltage, one phase voltage is taken as Reference 0 and other phase voltage as 440 V. APFC CT (Current Transformer) need to be installed on the third phase at main incomer ACB after transformer, which will give signal to the APFC Relay. Based on this input the ASIC (Application Specific Integrated Circuit) or Call it as Microprocessor internal to the APFC Relay will give output signal to relay outputs which will energize coil of the contactor so that the contactor come in line connecting the capacitor bank in circuit. However, this is step correction means PF is corrected in steps. The Voltage rise due to connection of capacitor banks is marginal. There will be no frequency correction with APFC System.

## **6.3 APFC PANEL ACCESSORIES**

- a. Power capacitor and control panel shall be housed in metal enclosed cubicle. Power capacitor shall be housed in the lower compartment and capacitor control panel at top compartment.
- b. The control equipment including capacitors shall be mounted in a panel of cold rolled sheet steel. The panel shall be of indoor type.
- c. Bus bars shall be of aluminium conductor and high conductivity.
- d. Isolating switch.
- e. Contactor with overload element.
- f. APFC Relays responsive to current/voltage/kVAR/PF for automatic switching shall be of microprocessor based suitable for state board Electricity with reduced power factor.
- g. Sequencing devices, timers and auxiliary relays for automatic sequential switching of the capacitors in and out of the circuit.
- h. Auto-manual selector switches.

- i. Push button for opening and closing the power circuit.
- j. Red and green cluster LED lights for capacitors ON/OFF indication
- k. Protective numerical relays to protect the healthy capacitor units when one unit fails in a series connection.
- l. Space heater and cubicle lighting as per the requirements.

## **7 CABLES AND CABLE CARRIER SYSTEM**

### **7.1 SCOPE**

- a. This specification also covers the design, material, construction features, manufacture, inspection and testing at the Vendor's/his Sub-Vendor's works and delivery to site of 33 kV HT Cables and LT Cables, Cabling Accessories, Cable Tray, Conduits and Pipes etc.

### **7.2 APPLICABLE CODES & STANDARDS**

- a. The design, construction, manufacture and performance of the equipment/components shall conform to latest applicable standards as on date of submission of the bid and comply with all currently applicable statutes, regulations and safety codes in the locality where the equipment/components will be installed. Nothing in this specification shall be construed to relieve the Vendor of this responsibility.
- b. Unless otherwise specified, equipment shall conform to the latest applicable standards for cables IS 1554, 7098, 8130, 5831, 3975, IEC 60183, 60227, 60502, 60885, 10418.

### **7.3 TECHNICAL SPECIFICATION FOR CABLES & CABLE TERMINATION**

- a. The various types of cables covered in this specification shall meet the following requirements:
  - XLPE Insulated HV Power Cables
    - i. The conductors shall be screened by extruded semi-conducting compound and XLPE insulated. The cores shall be screened by extruded semi-conducting compound in combination with non-magnetic metallic tape (copper tape preferred). The inner sheath over laid up cores and outer sheath over the armour shall be extruded black PVC compound type ST-2. Core identification shall be by printed numerals. The construction, performance and testing of the cable shall comply with IS 7098-Part 2 (Cross Linked Polyethylene Insulated PVC Sheathed Cables for working voltages from 3.3kV upto and including 33kV).

- 1100 V Grade XLPE Insulated Power Cables
  - i. The cable shall be extruded XLPE insulated. The inner sheath over laid up cores and outer sheath over the armour shall be extruded PVC compound type ST-2. Core identification shall be by printed numerals. The construction, performance and testing of the cable shall comply with IS 7098-Part 1 (Cross linked polyethylene insulated PVC sheathed cables for working voltages upto and including 1100 V).
- 1100 V grade PVC insulated Power / Control Cables
  - i. The cables shall be insulated with extruded PVC compound type C, provided with inner sheath and outer sheath of extruded black PVC compound type ST-2.
  - ii. The construction, performance and testing of the cable shall comply with IS 1554 - Part 1 (PVC insulated heavy duty electric cables for working voltages upto and including 1100 V).
- 1100 V Grade Lighting/Misc./Light duty Unarmoured cables
  - i. Cables shall be insulated with extruded PVC type-C. Outer sheath shall be extruded black PVC type ST-2. The sheathed cables shall be weather proof suitable for indoor/outdoor use. Twin and multicore cables shall be laid up and filled with thermoplastic material, bound by plastic tape and provided with outer sheath.
  - ii. The construction, performance and testing of the cable shall comply with IS 694 (PVC insulated cables for working voltages upto and including 1100 V).
- For all LT power and control cables, double compression glands with aluminium lugs for Aluminium cables and tinned Copper lugs for Copper cables shall be used in indoor and outdoor application.
- The termination shall be inclusive of miscellaneous items such as clamps, cleats, cable tags, cable markers etc.
- In general, cable installation works shall be carried out in accordance with IS 1255, latest version. At road crossings, the depth of the Pipe shall be minimum 1m else proper concrete encasing shall be provided.
- For Underground cables, cable marker shall project 150mm above ground and shall be spaced at an interval of 30 metres, and at every change in direction. They shall be located on both side of road and drain crossings. Top of cable marker/joint marker shall be sloped, to avoid accumulation of water/dust on marker. On finished surface like foot path etc., the marking shall be accomplished with a separate colour tiles/ paver block for highlighting the route of the cable.

- Cable Glands
  - i. Double compression type cable glands shall be used for the termination of all the power and control cables. Cable glands shall be brass casting, machine finished and Nickel-plated to avoid corrosion and oxidation. Rubber components used in cable gland shall be of neoprene.
  - ii. For single core cables, gland shall be with brass ring.
  - iii. Cable glands shall be with metric threads.
  - iv. Cable glands shall be conical (& not flange type).
- Cable Lugs
  - i. Cable lugs shall be of tinned Copper, solder less crimping type for Cu cables & Al lugs for the Al cables.
  - ii. The current rating of the lugs shall be same as that of the respective cable conductors.
  - iii. Ring type cable terminations shall be used.
  - iv. Insulated lugs are not acceptable for any cable terminations.
  - v. Bi-metal strip/ Bi-metallic lug shall be used whenever two different metals are to be connected together.
  - vi. Double hole extended neck (long barrel neck) type lugs shall be used in case of cables above 185 sq. mm.
  - vii. Fork terminals shall be used for luminaires & decorative switch/ socket. Pin terminals may be acceptable during execution only in case other terminals/ lugs cannot be accommodated.
  - viii. Reducer / wire pin terminals shall be avoided for MCB terminations. MCB terminations shall be with 'long palm terminals.
  - ix. All terminations in Feeder Pillars / enclosure for earthing & neutral busbars / terminals shall be with ring type terminals.
  - x. All earthing terminations shall be with ring type lugs only.
  - xi. All control & interlock cable terminations shall be with ring type lugs.
  - xii. Anticorrosion/ anti-oxidation compounds shall be used for crimping lugs [This shall especially be ensured for Al cable terminations & any bimetallic terminations (Cu cable termination using tinned Copper lugs)].
  - xiii. If termination is done with crimping tool employing crimping die, then forming dies shall be used to make the sector shaped conductor into a round conductor before crimping the lugs on the conductor. The lug must not be crimped directly on the sector conductor. Before crimping the lug, the conductor shall be thoroughly cleaned and special jelly applied over it to prevent further oxidation.

- The cable carrier system covers the supply of cable racks, cable trays and its supporting accessories hardware and their installation. It shall be the responsibility of the Contractor to complete the cabling system in all respects.
- Cable trays shall be of Galvanised Steel and of ladder / perforated type, complete with all necessary coupler plates, elbows, tees, bends, reducers, stiffeners and other accessories and hardware as required. All hardware (i.e. bolts, nuts, screws, washers, etc.) shall be hot dip galvanized. (galvanization thickness not less than 70 microns).
- Each 3-metre section of all types of cable trays and all elbows, tees, crosses, etc. shall be provided with two side coupler plates and associated bolts, nuts and washers.
- DWC pipes used for laying cable shall be as per IS 14930 Part II / IS 16205 Part 24: 2018.

## **8 DIESEL GENERATOR SET**

### **8.1 GENERAL**

- a. The equipment shall be complete with all necessary accessories and components as required as per IS standard for trouble free installation & operation.
- b. The generator shall have output rating sufficient to evacuate the output of the engine at rated power factor over complete range of site ambient conditions.
- c. The DG set shall be supplied with acoustic enclosure conforming to relevant standards.
- d. The generator shall be capable of satisfactory continuous operation at rated kVA and power factor at any voltage from 90% to 110% and within a frequency range of 47.5 Hz to 52.5 Hz.
- e. The generator shall have overload capacity as per applicable standards. The generator shall be capable of withstanding a three-phase short circuit at generator terminals when operating at rated kVA and power factor, 5% over voltage and with fixed excitation for 3 seconds.

### **8.2 EARTHING**

- a. In DG, 4-point earthing system are to be considered out of which 2 points are for body earthing with GI strip and 2 point is for alternator neutral earthing with Copper strip.



### 8.3 PIPING

- a. All other associated piping, valves and other item necessary for completeness of equipment shall be supplied by the Contractor.

### 8.4 UNLOADING

- a. Gensets without Acoustic Enclosure.
  - Genset should not be lifted from engine and alternator hooks. These are designed for lifting individual items only. Normally, provision for Genset lifting is provided on base- rails. The Genset should be unloaded from base rail by lifting with proper Genset lifting tackle or nylon sling/steel rope of suitable capacity and crane so as to ensure no damage to oil sump, air cleaner, radiator pipes etc.
  - Genset should be covered with polyethylene or tarpaulin during installation to ensure that water does not enter inside.
  - Spreader bar/ spacer plate of suitable size may be required to avoid damages to Genset components.
- b. DG set with Acoustic enclosures are provided with lifting hooks.

### 8.5 LOCATION

- a. DG Sets with Acoustic Enclosure
  - DG sets are required to be supplied with acoustic enclosure. DG Set with acoustic enclosure shall preferably be installed outside the building (including terrace subject to structural feasibility) & location should be finalized in consultation with the Architect. However, DG set should be as near to the substation as possible i.e. as near to Essential LT Panel as possible. Associated AMF panel/ Electrical panel of the DG Set can be located inside the acoustic enclosure or outside the acoustic enclosure as per manufacturer standard. In case, AMF/ Electrical panel has to be installed outside the acoustic enclosure, location of room to house AMF/ Electrical panel should be decided in consultation with the Architect so that it shall be as near to the acoustic enclosure as possible. Specially, in case of connection through bus trunking, care should be taken for aesthetics.

### 8.6 NOMINAL RATINGS OF DG SETS

- a. DG Sets are normally available in following standard capacities: (Ratings in KVA)

7.5	10	12.5	15	17.5	25	30	35	40	50	62.5
-----	----	------	----	------	----	----	----	----	----	------

75	82.5	110	125	140	200	225	250	320	350	380
415	450	500	550	600	625	700	750	1010	1250	1500

## 8.7 CLIMATIC CONDITIONS

- a. The output of DG Set shall be specified in tender documents under actual site conditions. The tenderer has to certify that the engine & alternator meets the capacity requirement after de-ration as per IS/ BIS. DG Set should be type tested for Noise and Emission.

## 8.8 DIESEL ENGINE

- a. The engine shall be of standard design of the original manufacturers. It should be 4 stroke cycles, water cooled, naturally aspirated/ turbo charged (as per manufacturer standard), diesel engine developing suitable BHP for giving a power rating as per ISO 8528- Part-1 in KVA at the load terminals of alternator at 1500 rpm at actual site conditions.
- b. The engine shall be capable for delivering specified Prime Power rating at variable loads for PF of 0.8 lag with 10% overload available in excess of specified output for one hour in every 12 hours. The average load factor of the engine over period of 24 hours shall be 0.85 (85%) for prime power output.
- c. The engine shall conform to IS: 10000/ ISO 3046/ BS:649/ BS 5514 amended up to date.
- d. Necessary certificate indicating the compliance of the above capacity requirement for the engine model so selected along with compliance of Noise and Emission norms as per latest CPCB guidelines for DG set capacity up to 1000 KVA, should be furnished from the manufacturers along with the technical bid. However above 1000 KVA DG set, manufacturers shall furnish certificate that the Engine for the DG set complies with the CPCB Emission norms.
- e. The engine shall be fitted with following accessories subject to the design of the manufacturer:
  - Dynamically balanced Fly wheel.
  - Necessary flexible coupling and guard for alternator and engine (applicable only for double bearing alternator).

- Air cleaner (dry/ oil bath type) as per manufacturer standard.
  - A mechanical/ electronic governor to maintain engine speed at all conditions of load.
  - Daily fuel service tank of minimum capacity as per Table below, fabricated from M.S. sheet with inlet, outlet connections air vent tap, drain plug and level indicator (gauge) M.S. fuel piping from tank to engine with valves, unions, reducers, flexible hose connection and floor mounting pedestals, twin fuel filters and fuel injectors. The location of the tank shall depend on standard manufacturers design.
- f. Dry exhaust manifold with suitable exhaust residential grade silencer to reduce the noise level.
  - g. Dry exhaust manifold with suitable exhaust residential grade silencer to reduce the noise level.
  - h. Suitable self-starter for 12 V/ 24 V DC.
  - i. Battery charging alternator unit and voltage regulator, suitable for starting batteries, battery racks with interconnecting leads and terminals.
  - j. Necessary gear driven oil pump for lubricating oil, priming of engine bearing as well as fuel systems as per manufacturer recommendations.
  - k. Naturally aspirated/ turbo charger (as per manufacturer standard).
  - l. Lubrication oil cooler.
  - m. Lubrication oil filters with replaceable elements.
  - n. Crank case heater as per manufacturer recommendations.
  - o. Fuel injection: Engine should have suitable fuel injection system in order to achieve low fuel consumption.
  - p. Fuel control solenoid.
  - q. Fuel pump with engine speed adjustment.
  - r. Engine Control Panel fitted and having digital display for following:
    - Start/stop key switch
    - Lube oil pressure indication
    - Water temp. indication
    - RPM indication
    - Engine Hours indications
    - Battery charging indication
    - Low lub. Oil trip indication
    - High water temp. indication
    - Over speed indication

- s. All moving parts of the engine shall be mechanically guarded in such a manner that a human finger cannot touch any moving part.
- t. Radiator/ Heat Exchanger System/ Remote Radiator (delete whichever is not applicable).
- u. Any other item not included/ specified but is a standard design of the manufacturer.

#### **8.9 GOVERNOR**

- a. Mechanical governor of class A2 for up to and including 200 KVA capacity and Electronic governor of class A1 for capacity above 200 KVA, as per ISO 3046/ BS 5514 with actuator shall be provided as per standard design of manufacturer. Governor shall be a self-contained unit capable of monitoring speed.

#### **8.10 FREQUENCY VARIATION**

- a. The engine speed shall be so maintained that frequency variation at constant load including no load shall remain within a band of 1% of rated frequency.

#### **8.11 FUEL SYSTEM**

- a. It shall be fed through engine driven fuel pump. A replaceable element of fuel filter shall be suitably located to permit easy servicing. The daily service tank shall be complete with necessary supports, gauges, connecting pipe work etc. In case of Top Mounted tanks, non-return valves are must in fuel supply and return line of specified value. Pipe sealant should be used for sealing for all connections. No Teflon tape to be used. If piping length is more than 10 meters, detail engineering is required in consultation with OEM.

#### **8.12 LUBRICATING OIL SYSTEM**

- a. It shall be so designed that when the engine starts after a long shut down lubrication failure does not occur. Necessary priming pump for the lub. oil circuit as per recommendation of manufacturer shall be installed, to keep bearings primed. This pump shall be normally automatically operative on AC/ DC supply available with the set.

#### **8.13 STARTING SYSTEM**

- a. This shall comprise of necessary set of heavy-duty batteries 12V/ 24V DC (as per manufacturer standard), and suitable starter motors, axial type gear to match with the toothed ring on the fly wheel. A timer in the control panel to protect the starter motor from excessively long cranking runs shall be suitably integrated with the

engine protection system and shall be included within the scope of the work. Battery capacity shall be suitable for meeting the needs of starting system (as three attempts starting), as well as the requirements of control panel, indications and auxiliaries such as priming pump as applicable etc. The scope shall cover all cabling, terminals, including initial charging etc. The system shall be capable of starting the DG set within 20-30 sec., even in winter condition with an ambient temperature down to 0°C.

#### **8.14 BATTERY CHARGER**

- a. The battery charger shall be suitable to charge required numbers of batteries at 12V/ 24V complete with, transformer, rectifier, charge rate selector switch, indicating ammeter & voltmeter etc. Connections between the battery charger & batteries shall be provided with suitable copper leads with lugs etc.

#### **8.15 PIPING WORK**

- a. All pipe lines and fittings and accessories requirement inside the room/ enclosure and outside for exhaust piping shall be provided by the Contractor. This shall include necessary flexible pieces in the exhaust, fuel, lub. oil and water lines as are necessary in view of the vibration isolation requirement in the installation. Piping of adequate size shall be used for lub. oil of the material as per manufacturer standard. However, only M.S. pipes for the exhaust shall be used. For fuel lines within the acoustic enclosure, PVC braided pipe as per manufacturer recommendations can be used. However, for fuel lines outside the acoustics enclosure only MS pipe be used.
- b. The pipe work shall be inclusive of all fittings and accessories required such as bends, reducers, elbows, flanges, flexible connections, necessary hardware etc. The installation shall cover clamps, supports, hangers etc. as are necessary for completing the work. However, the work shall be sectionalized with flanged connections as are necessary for easy isolation for purposes for maintenance of unit as approved by Engineer-in-charge.

#### **8.16 COMMON BED PLATE**

- a. Engine and alternator shall be directly coupled or coupled by means of flex plate/ flexible coupling as per manufacturer standard design and both units shall be mounted on a common bed plate together with all auxiliaries to ensure perfect alignment of engine and alternator with minimum vibrations. The bed plate shall be suitable for installation on suitable anti-vibration mounting system.

## 8.17 EXHAUST SYSTEM:

- a. Exhaust Piping: All M.S. Pipes for exhaust lines shall be conforming to relevant IS. The runs forming part of factory assembly on the engine flexible connections up to exhaust silencer shall be exclusive of exhaust piping item. The work includes necessary cladding of exhaust pipe work using 50 mm thick Loosely bound resin (LBR) mattress/ mineral wool/ Rockwool, density not less than 120 kg/m<sup>3</sup> and aluminium cladding (0.6 mm thick) for the complete portion. The exhaust pipe work includes necessary supports, foundation etc. to avoid any load & stress on turbo charger / exhaust piping. The exhaust pipe shall run along the existing wall of the building duly clamped/supported on independent structure for which, the design and Drawing for such structure shall be got approved from the Engineer-in-charge.
- b. Exhaust system should create minimum back pressure.
- c. Number of bends should be kept minimum and smooth bends should be used to minimize back pressure.
- d. Pipe sleeve of larger dia. should be used while passing the pipe through concrete wall & gap should be filled with felt lining.
- e. Exhaust piping inside the Acoustic Enclosure/ Genset room should be lagged with asbestos rope along with aluminium sheet cladding / insulated to avoid heat input to the room.
- f. Exhaust flexible shall have its free length when it is installed. For bigger engines, 2 flexible bellows can be used.
- g. For engines up to 500 KVA, only one bellow is required. However, if exhaust pipe length is more than 7 m then additional bellow/ provision for expansion should be provided.
- h. 'Schedule B' MS pipes and long bend/elbows should be used.
- i. The exhaust outlet should be in the direction of prevailing winds and should not allow exhaust gases to enter air inlet/ windows etc.
- j. When tail end is horizontal, 45 Degree downward cut should be given at the end of the pipe to avoid rain water entry into exhaust piping.
- k. When tail end is vertical, there should be rain trap to avoid rain water entry. If rain cap is used, the distance between exhaust pipe and rain cap should be higher than diameter of pipe. Horizontal run of exhaust piping should slope downwards away from engine to the condensate trap. Silencer should be installed with drain plug at bottom.

- i. Optimum Silencer Location: Location of the silencer in exhaust system has very definite influence on both reduction of noise and back pressure imposed on the system. The preferred silencer locations are given in the Table below, where L is length of the total exhaust system measured from exhaust manifold in meters. Please note that locating the silencer as per optimum silencer location is not mandatory. For high rise buildings, suitable arrangements may have to be provided in consultation with acoustics engineer.

<b>Table – 1 Optimum Location of Silencer (In meters)</b>		
	<b>In-line Engine</b>	<b>‘V’ Engine</b>
Best	2L/5	(4L – 1.5) / 5
Second best	4L/5	(2L – 4.5) / 5
Worst Location of Silencer	L/5 or 3L/5 or at tail end of Exhaust piping	(3L - 10)/ 5 or at the tail end of Exhaust piping

- m. Exhaust Stack Height:

- In order to dispose exhaust above building height, minimum exhaust stack height should be as follows: -
- FOR DG SET UP TO 1000 KVA: -  
 $H = h + 0.2$   
 Where H = height of exhaust stack h = height of nearby building
- FOR DG SET ABOVE 1000 KVA: -  
 30 m High or 3 m above the building height, whichever is higher.
- Care should be taken to ensure that no carbon particles emitted due to exhaust leakage enters and deposits on alternator windings and on open connections.
- Support to Exhaust Piping: Exhaust piping should be supported in such manner that load of exhaust piping is not exerted to turbocharger.

- n. Exhaust Stack Height shall strictly comply with local regulations.

## **8.18 AIR SYSTEM**

- a. It is preferable to provide vacuum indicator with all engines to indicate choked filter. Maximum air intake restrictions with clean and choked filters should be within prescribed limit as per OEM recommendation for the particular model of the

engine. Gensets should be supplied with medium duty/ heavy duty air cleaners (specify one only). (Heavy duty air cleaner should be used for installations in dusty or polluted surroundings.)

#### **8.19 COOLING SYSTEM**

- a. System should be designed for ambient temperature of 45oC.
- b. Water softening/ demineralizing plants should be used, if raw water quality is not acceptable.
- c. Coolant should be used mixed with additive (in suitable proportion) as per recommendation of OEM for various engine models.
- d. Radiator fan flow should be free from any obstruction.
- e. For radiator cooled DG Set, proper room ventilation should be planned at the time of construction of DG room.
- f. Remote Radiator can be used in case of basement installation where fresh air may not be available. The proper location of remote radiator is very essential for the successful and efficient operation of remote radiator. In this the cooling media is ambient air. So, in order to obtain maximum efficiency from remote radiator, it is necessary to get fresh air in its surrounding. The horizontal distance of remote radiator from engine should not exceed 10 Meter.
- g. For the dusty or polluted surroundings (as radiator gets clogged) and/ or bigger capacity Gensets (say 1000 KVA and above), installation of Cooling System with Heat Exchanger system may be used.
- h. Optional items as under may be included as per site requirement at the discretion of Technical Sanctioning authority:
  - Cooling System
  - Remote Radiator
  - Jacket Water Heater
  - Crankcase Oil Heater
  - After cooler jacket turbo charger electrical pre heat systems.
  - Fuel System
  - Fuel Water Separator
  - Auxiliary Fuel Pump
  - Exhaust System
  - Industrial Grade Muffler
  - Residential Grade Muffler
  - Critical Grade Muffler
  - Super Critical Grade Muffler
  - Start System



- Battery Warmer Plate
- Battery Charger
- Automatic Float Equalizing
- Trickle

## 8.20 ALTERNATOR

- a. Synchronous Alternator: Self-excited, screen protected, self-regulated, brush less alternator, Horizontal foot mounted in Single/Double bearing construction (specify one only) suitable for the following:

**Table - 2 Alternator data sheet**

Rated PF	:	0.8 (lag)
Rated voltage	:	415 volts
Rated frequency	:	50 Hz
No. of Phases	:	3
Enclosure	:	SPDP
Degree of protection	:	IP-23
Ventilation	:	Self ventilated air cooled
Ambient Temperature	:	45° C Maximum
Insulation Class	:	F/H
Temperature Rise	:	Within class F/H limits at rated load
Voltage Regulation	:	+/- 1%
Voltage Variation	:	+/- 5%
Overload duration/capacity	:	10% for one hour in every 12 hours of continuous use.
Frequency variation	:	As defined by the Engine Governor (+/- 1%)

Excitation	:	Self / separately excited (Self excitation upto 750 KVA and separately excited system above 750 KVA)
Type of AVR	:	Electronic
Type of Bearing and Lubrication arrangement	:	Anti-friction bearings with Grease lubrication
Standard	:	IS 4722 & IEC:34 as amended upto date.

- b. Alternator should be able to deliver output rating at actual site conditions.
- c. The alternator above 500 KVA capacity shall be fitted with suitable Nos. Resistance Temperature Device (RTD) & Bearing Temperature Device (BTD) alongwith space heaters. The terminal of space heaters will be wired to terminal box and the temperature scanner shall be provided in control panel for scaling the winding and bearing temperature.
- d. Excitation: The alternator shall be brushless type and shall be self/ separately excited, self- regulated having static excitation facility. The exciter unit be mounted on the control panel or on the alternator assembly. The rectifier shall be suitable for operation at high ambient temperature at site.
- e. Automatic Voltage Regulators (AVR): In order to maintain output terminal voltage constant within the regulation limits i.e.+/- 1%, Automatic voltage regulator unit shall be provided as per standard practice of manufacturer.
- f. Fault Tripping: In the event of any fault e.g. over voltage/ high bearing temperature/ high winding temperature or an external fault, the AVR shall remove the excitation voltage to the alternator. An emergency trip shall also be provided.
- g. Standards: The alternator shall be in accordance with the following standards as are applicable.
  - IS 4722/ BS 2613: 1970. The performance of rotating electrical machine.
  - IS 4889/ BS 269 rules for method of declaring efficiency of electrical machine.
- h. Performance: Voltage dip shall not exceed 20% of the rated voltage for any step load or transient load as per ISO 8528 (Part-1). The winding shall not develop hot

- spots exceeding safe limits due to imbalance of 20% between any two phases from no load to full load.
- i. Generator shall preferably be capable of withstanding a current equal to 1.5 times the rated current for a period of not more than 15 seconds as required vide clause 14.1.1 of IS 4722:1992.
  - j. The performance characteristics of the alternator shall be as below:
    - Efficiency at full load 0.8 P.F.
      - i. Upto 25 KVA – not less than 82%
      - ii. Above 25 KVA and upto 62.5 KVA – not less than 86%
      - iii. Above 62.5 KVA & upto 250 KVA – not less than 90%
      - iv. Above 250 KVA – not less than 93.5%
      - v. Total distortion factor Less than 3 %
    - Overloading
      - i. 10% overload - One hour in every 12 hrs of continuous use.
      - ii. 50% overload - 15 seconds.
  - k. Terminal Boxes: Terminal boxes shall be suitable for U.G. cables/ Bus Trunking. The terminal box shall be suitable to withstand the mechanical and thermal stresses developed due to any short circuit at the terminals.
  - l. Earth Terminals: 2 Nos. earth terminals on opposite side with vibration proof connections, non-ferrous hardware etc. with galvanized plate and passivated washer of minimum size 12 mm dia. hole shall be provided.
  - m. Space Heaters: Alternators of capacity more than 500 KVA shall be provided with suitable space heaters to maintain the winding temperature automatically such that it does not absorb moisture during long idle periods. The heater terminals shall be brought to a separate terminal box suitable for 230 V AC supply and a permanent caution notice shall be displayed.

## **8.21 AMF PANEL, BATTERIES AND ELECTRICAL SYSTEM**

- a. Battery/ Electrical System
  - Batteries supplied with Genset are generally dry and uncharged. First charging of uncharged batteries is very important and should be done from authorized battery charging centre. Initial charging should be done for 72-80 hours.
  - Batteries should be placed on stands and relatively at cool place.
  - Battery capacity and copper cable sizes for various engine capacity are recommended as indicated in the table below. Cable sizes shown are for maximum length of 2 m. If length is more, cable size should be selected in

such a way that voltage drop does not exceed 2 V. However, capacity as recommended by manufacturer may be taken.

- For AMF applications, a static battery charger working on mains supply is recommended to keep the batteries charged at all times.
- 1.5 sq.mm copper wire should be used for wiring between junction box and Control Panel.

b. Cabling

- Power cabling between alternator and control panel and control panel and change over switch to mains should be done with recommended cable sizes.
- Overheating due to loose thimbling / undersize cables causes most of electrical failures, hence correct size of cable and thimbles should always be used, if cable is specified.
- While terminating cables, avoid any tension on the bolts/ busbars (if cable is specified). While terminating R, Y& B phase notations should be maintained in the alternator and control panel for easy maintenance.
- Crimped cables should be connected to alternator and control panel through cable glands, if cable is specified.
- Multi-core copper cables should be used for inter connecting the engine controls with the switchgear and other equipment.
- For AMF application, multicore 1.5 sq.mm flexible stranded copper cable for control cabling should be used.
- It is recommended to support output cables on separate structure on ground so that weight of cables should not fall on alternator/ base rail.
- External wirings, when provided for remote voltage / excitation monitoring/ droop CT etc. shall be screened sheathed type. Maximum length of such wiring shall not exceed 5 meters.

c. Alternator Termination Links

- For proper terminations between links and switchgear terminals, the contact area must be adequate. The following situations should also be avoided as they lead to creation of heat sources at the point of termination:
- Point contact arising out of improper position of links with switchgear terminals.
- Gaps between busbars / links and terminals being remedied by connecting bolt/stud. In such cases the bolt will carry the load current. Normally these bolts / studs are made of MS and hence are not designed to carry currents.

- Adequate clearance between busbars / links at terminals should be maintained (IS 4232 may be referred to for guidelines).
- Improper termination will lead to local heat generation which may lead to failure.

## **8.22 FOUNDATION**

### **a. Genset with Acoustic Enclosure**

- For DG Sets installed inside the DG Set Room - A PCC foundation (1:2:4, M-20 grade) of approximate depth 150 mm above the finished Genset Room Floor level is required so as to provide levelled surface for placement of the acoustics enclosure. The length and breadth of foundation should be at least 250 mm more on all sides than the size of the enclosure. Genset should be mounted on AVM's inside the enclosure.
- For DG Sets installed outside in open area - A PCC (1:2:4, M-20 grade) foundation of weight 2.5 times the operating weight of the Genset with enclosure or as recommended by the Genset manufacturer OEM/OEA, whichever is higher, is required to be provided and is included in scope of work for SITC of Genset. 300 mm of this foundation height should be above the ground level. The length and breadth of foundation should be at least 250 mm more on all sides than the size of enclosure. Genset should be mounted on AVM's inside the enclosure.

## **8.23 ACOUSTIC ENCLOSURE**

### **a. Installation**

- Acoustic enclosures are supplied with built in Anti Vibration Mountings (AVMs). As such Genset can be installed directly on the levelled surface.
- Exhaust piping outlet should not be turned towards window / ventilator of home or occupied building. Provision of rain cap should be ensured.
- The acoustic enclosure placement should be such that there is no restriction in front of air inlet and outlet from canopy.

### **b. Service Accessibility**

- Genset / Engine control panel should be visible from outside the enclosure.
- Routine / periodical check on engine / alternator (filter replacement and tappet setting etc.) should be possible without dismantling acoustic enclosure.
- For major repairs / overhaul, it may be required to dismantle the acoustic enclosure.
- Sufficient space should be available around the Genset for inspection and service.

c. General Design Guidelines

- To avoid re-circulation of hot air, durable sealing between radiator and canopy is must.
- Ventilation fans are must for the Gensets cooled by heat-exchanger/cooling tower system.
- Exhaust piping inside the enclosure must be lagged (except bellow).
- Temperature rise inside the enclosure should not be more than 5°C for maximum ambient above 45°C and it should be below 10°C for ambient below 45°C.
- There should be provision for oil, coolant drain and fill. Fuel tank should have provision for cleaning.
- The enclosure should be designed to meet the total air requirement for the D.G. Set at full load at site conditions as recommended by the engine manufacturer.

d. Specifications for Acoustic Enclosure

- The acoustic enclosure shall be designed and manufactured confirming to relevant standards suitable for outdoor installation exposed to weather conditions, and to limit overall noise level to 75 dB (A) at a distance of 1 mtr. from the enclosure as per CPCB norms under free field conditions.
- The construction should be such that it prevents entry of rain water splashing into the enclosure and allows free & quick flow of rain water to the ground in the event of heavy rain. The detailed construction shall conform to the details as under:
- The enclosure shall be fabricated out the CRCA sheet of thickness not less than 1.6 mm on the outside cover with inside cover having not less than 0.6 mm thick perforated powder coated CRCA sheet.
- The hinged doors shall be made from not less than 16 SWG (1.6 mm) thick CRCA sheet and will be made air tight with neoprene rubber gasket and heavy-duty locks.
- All sheet metal parts should be processed through 7-tank process.
- The enclosure should be powder coated.
- The enclosure should accommodate the daily service fuel tank of the D.G. Set to make the system compact. There should be provision of fuel gauge, which should show the level of the fuel even when the DG Set is not running. The gauge should be calibrated. The fuel tank should be filled from the outside as in automobiles and should be with a lockable cap.
- The batteries should be accommodated in the enclosure in battery rack.

- The canopy should be provided with high enclosure temperature safety device.
  - The acoustic lining should be made up of high-quality insulation material i.e. rockwool/ glass/ mineral wool/ PU foam of appropriate thickness & density for sound absorption as per standard design of manufacturers to reduce the sound level as per CPCB norms. The insulation material shall be covered with fine glass fiber cloth and would be supported by perforated M. S. Sheet duly powder coated / GI sheet/ aluminium sheet.
  - The enclosure shall be provided with suitable size & No. of hinged type doors along the length of the enclosure on each side for easy access inside the acoustic enclosure for inspection, operation and maintenance purpose. Sufficient space will be provided inside the enclosure on all sides of the D.G. set for inspection, easy maintenance & repairs.
  - The canopy should be as compact as possible with good aesthetic look.
  - The complete enclosure shall be of modular construction.
  - The forced ventilation shall be as per manufacturer design using either engine radiator fan or additional blower fan(s). If the acoustic enclosure is to be provided with forced ventilation, then suitable size of axial flow fan (with motor and auto-start arrangement) and suitable size axial flow exhaust fan to take the hot air from the enclosure complete with necessary motors and auto start arrangement should be provided. The forced ventilation arrangement should be provided with auto stop arrangement to stop after 5 minutes of the stopping of D.G sets.
  - The acoustic enclosure should be suitable for cable connection/connection through bus-trunking. Such arrangements on acoustic enclosure should be water proof & dust-proof conforming to IP-65 protection.
  - The inside of enclosure should be provided with at least two nos. 15 W-LED light luminaire controlled by a 5A switch for adequate lighting during servicing etc. of the DG Set. The power supply to this luminaire should be from the load side of the AMF Panel so that it can remain energized under all conditions.
- e. Specific Requirements of DG Panel: General operation philosophy
- No volt relays provided in the Main LT panel / DG controller will monitor the grid voltage. In the event of grid supply failure Controller will trip the grid incomer breakers and also give initiating signal to DG for auto starting. For this, DG Local/Remote/Test mode selector switch is in Remote mode and DG Auto/Manual selection shall be selected for Auto.
  - DG Controller shall perform the following function:

- i. Automatic starting, load sharing and stopping of DG sets based on variation in load.
  - ii. There should be facility in panel to test the DG Sets.
  - iii. Facility for remote alarm indication for “AMF set in operation”, “AMF fails to start” shall be provided through potential free contact.
- f. The DGs will not run in parallel with State electricity board grid.
- g. Separate numerical relay for IDMT over current, short circuit fault and earth fault i.e. 51 & 51N protection shall be provided. Relays should have RS485 port at front side. Relays and protection shall be enabled for SCADA/BMS compatibility with IEC 61850 protocol.
- h. Generator protection relays shall be supplied with latest version software and hardware without any extra cost. It should be possible to set relay, view fault parameters, download information from relay to computer connected system.
- i. For DG incomer(s) separate master trip relay ‘86’ (VAJHM23), trip circuit supervision relay ‘95’ (VAX31) shall be provided. These shall be separate electromechanical relays and not as element of numerical relay.
- j. DG Set Controller shall be considered for integration with SCADA.
- k. DG controller shall be suitable for single genset operation as well as multi- genset operation which includes Island operation, Fixed power/ base load, AMF & ATS, peak shaving, Load takeover, AMF mode.
- l. The DG controller shall be a part of DG panel. DG controller shall have following minimum inbuilt electrical protections:
  - Reverse power (32)
  - Short Circuit (50P/N)
  - Overcurrent (51)
  - Negative phase sequence (46)
  - Unbalance Protection (47)
  - Under/ Over Voltage (27/59)
  - Under / Over Frequency (81R/81O)
  - DG controller shall have following minimum engine side protections:
    - Overspeed / Under speed shutdown
    - Low/ High Battery Voltage
    - Battery test alarm
    - Fail to Crank shutdown
    - Cranking lockout
    - Incomplete start after a preset time
    - Low fuel warning / shutdown
    - Jacket water high temperature



- Low lube oil Pressure after the DG has attained 90% speed
  - DC control supply failure
  - Engine trip due to generator fault
- m. One Annunciator with Test, Accept, Reset & Mute push button and hooter along with following annunciations shall be provided for incomer feeder: Auxiliary voltage for the window type annunciation system shall be derived from the battery.
- Engine fails to start
  - DG on load test
  - Engine trip due to generator fault
  - High jacket water temperature
  - High lube oil temperature
  - High differential pressure across lube oil filter
  - Bearing temp. High alarm
  - Winding temp. High alarm
  - Emergency DG stop
  - Starting air pressure low (if applicable)
  - Diesel level low indication
  - Diesel level high indication
  - Low lube oil pressure and trip of the engine
  - High water temperature (if applicable)
  - Engine over-speed and trip
  - Engine / Alternator common fault
  - Multifunction relay (51, 51N) operated
  - Lube oil priming pump (if provided) in operation
  - Voltage out of limit
  - Ground fault in the system
  - AC/DC control supply failure
  - DG is paralleled with the main source (grid)
  - Battery fully discharged
  - Charger failure
  - Spare (4 Nos.)
  - The below mentioned signals shall also be provided as potential free contacts for remote annunciation.
  - DG over load
  - DG trouble (group annunciation)
  - Engine failed to start

- Engine ON
  - Engine tripped on fault
- n. R, Y, B indication lamps, Local/Remote selector switch, Auto/Manual selector switch, Voltage Raise/Lower, Speed Raise/Lower selector switch, Lamp test push button, Emergency trip push button shall be considered for incomer. Trip shall be independent of local/remote.
- o. Incomer of panel shall be provided with analogue ammeter with ammeter selector switch, analogue voltmeter with voltmeter selector switch, analogue kW meter.
- Multifunction meters (MFM) shall be provided for all incomers/outgoing feeders.
  - Looping of all RS485 ports shall be done using 3 cores twisted & shielded 1.5 sq.mm Cu cables and shall be terminated at incomer

#### **8.24 SPARE PARTS**

- a. The Bidder shall furnish a list of recommended spare parts for five years operation along with unit prices. .

#### **8.25 MAINTENANCE REQUIREMENTS**

- a. Easy access shall be provided for all components in the switchgear for maintenance.
- b. As far as possible the switchgear shall be so designed that no special tools are necessary for installation and maintenance. However, if special tools are required, the Bidder shall include price of one complete set in his bid.
- c. The Bidder shall recommend spares for Five (5) years trouble free operation.
- d. Vendor shall furnish detailed inter panel wiring diagrams, internal wiring diagrams, detailed component layout drawings to enable the Owner to carry out maintenance work.

### **9 EARTHING SYSTEM**

#### **9.1 SCOPE**

- a. This specification covers supply, design, installation, commissioning & testing of items required for earthing system including grounding conductors, rods, fittings, accessories and hardware to permanently and effectively ground the neutral points of transformers/ DG Sets, electrical apparatus, electrical equipment

frames, conduit, cable trays and all non-current-carrying metal parts, including structural steel and fences.

- b. The equipment shall be complete with all necessary accessories and components as required as per IS standard and APWD requirements.
- c. The safety earthing and lightning protection system has been designed on the basis of following codes and standards.
  - IS 3043: Code of practice for Safety Earthing
  - IS/IEC 62305: Protection against lightning
  - IEEE 80: IEEE Guide for Safety in Sub-station Earthing
  - Central Electricity Authority (CEA) Regulations – 2010
  - IEEE 1100- Electronic Earthing
  - The galvanising of the earthing material will be done as per IS 2629.

## **9.2 GROUNDING SYSTEM**

- a. The design of the equipment shall meet the following requirements:
  - It should provide means to dissipate the current into the earth during normal and fault conditions without exceeding the operating and substation equipment limits and connections.
  - The ground grid shall provide least resistance path for grounded neutral circuits.
  - The ground grid shall provide means of discharging current carrying parts which are to be handled by personnel.
  - Grounding consists of all conductors, ground rods, connectors and all other necessary items to make a complete grounding system.
  - The Contractor shall finalize the layout of the grounding system as required for the final equipment dimensions and locations.
  - The ground grid shall be designed so as to provide a maximum ground resistance of 1 ohm or less or as per local requirements.
  - Ground grid shall be installed at a minimum depth of 600 mm from ground level & at least 1500 mm away from the edge of the building.
  - Earthing of transformers will be done separately through electrodes (chemical or conventional as per direction of Engineer-in-charge) & further connected to the main collector network using connectors/ risers.
  - Where the ground conductor crosses the cable/ pipe trenches, the conductor shall be suitably lowered so as to cross cable trench at least 150 mm below its bottom surface.

- Risers shall be brought out above the ground level for further extension and connection to equipment.
- All conductors in the ground grid shall be welded together at every crossing and at every point where from risers emanate. Continuous lap welding shall be done instead of tack welding.
- The risers from the grid shall be laid to avoid contact with reinforcement to guard against false grounding during resistance tests.
- All non-carrying current metal parts of electrical equipment and apparatus shall be earthed with two separate diametrically/ diagonally opposite connectors. The apparatus shall include:
  - i. Bodies of electrical machinery, transformers etc.
  - ii. Frames of panels and cubicles
  - iii. Metallic structures of switchgear, casing of cable boxes
  - iv. Shielding of cables and electrical wiring conduits

### **9.3 DESIGN CRITERIA**

- a. Fault Current & Duration
  - The earthing system will be designed for fault current of 25kA for 1 sec or as per actual fault current.
- b. Soil Resistivity
  - The Contractor shall undertake the soil resistivity measurements at site and select suitable type of conductors.

## **10 LIGHTNING PROTECTION SYSTEM**

### **10.1 GENERAL**

- a. Design, Supply & installation of Lightning Protection System shall be strictly in accordance with IS/IEC: 62305-2010 or latest.

### **10.2 ZONE OF PROTECTION**

- a. The zone of protection of a lightning conductor defines the space within which a lightning conductor provides protection against a direct lightning stroke by diverting the stroke to itself. For a single vertical conductor, this zone is described as a cone with its apex at the highest point of the conductor and with an angle called as protective angle.

### **10.3 MATERIAL AND DIMENSIONS**

- a. The materials of lightning conductor, down conductors, earth termination etc. shall be GI and shall be protected against corrosion.
- b. All air terminations and down conductors shall be of GI and shall conform to IS/IEC: 62305-2010.
- c. Joints and Bonds
- d. The lightning protective system shall have as few joints as far as possible. Wherever joints in the conductor are necessary they shall be mechanically and electrically effective and shall be riveted and brazed in case of copper and by welding / bolting in case of GI in an approved manner.
- e. Earth Terminations
- f. Each down conductor shall have an independent earth termination. All the earth termination shall be inter-connected and shall be capable of isolation for testing. Test Link should be provided for isolation purpose.

### **10.4 EARTH ELECTRODE**

- a. The earthing type (chemical / conventional) shall be as per electrical inspector or APDCL or client requirement in line with the provisions of IS 3043.

### **10.5 DOWN CONDUCTOR**

- a. In order to reduce probability of damage it is often necessary to have several parallel current paths. As recommended by IS/IEC: 62305-2010 equal spacing of down conductors, 25 x 6 mm GI external strip, around the building perimeter.
- b. The down conductor must be kept in constant physical contact with the structure via conductive mounting clamps.
- c. Each down conductor shall be directly connected at the dedicated earthing pit and the dedicated Earth pit shall be connected to the other earth pits in the earthing grid.
- d. Alternatively, steel reinforcement can be used as down conductor in line with IS/IEC: 62305-2010.

## **11 ELEVATOR**

### **11.1 SCOPE**

- a. This specification covers design, supply, installation, testing & commissioning of items required for earthing system including grounding conductors, rods, fittings, accessories of Elevators.

- b. The work shall be carried out in accordance with PWD general specification for electrical work and as per relevant IS codes of practice with regulation of local codes/Bye-laws as per the direction of Engineer-in-charge. The following codes/specifications shall be generally adhered to:
- c. IS 14665 (Part 1) Electric traction lifts – Part 1: Guidelines for outline dimension of passenger, goods, service and hospital lifts
- d. IS 14665 (Part 2 / Sec 1 & 2): Electric traction lifts – Part 2: Code of practice for installation, operation and maintenance – Section 1: Passenger and goods lifts – Section 2 : Service lifts.
- e. IS 14665 (Part 3 / Sec 1 & 2): Electric traction lifts – Part 3: Safety rules - Section 1: Passenger and goods lifts – Section 2 : Service lifts.
- f. IS 14665 (Part 4 / Sec 1 & 2): Electric traction lifts – Part 4: Components – Section 1: lifts buffers – Section 2: Lift guide rails and guide shoes – Section 3: lift carfra.
- g. IS 14665 (Part 5 / Sec 1 & 2): Electric traction lifts – Part 5: Inspection manual.

## **11.2 EXTENT OF WORK**

- a. The extent of work covered by this specification is as follows:
  - Design, fabrication and supply of lift complete with all devices as are necessary to complete the installation in accordance with this specification.
  - Complete wiring of all electrical equipment from the point of supply onwards required for the safe and satisfactory operation of the lift as specified herein. The Owner will provide 415 Volts, 3 Phase, 4 Wire supply at one point for each Elevator.
  - Installation and commissioning of the lift equipment shall be complete with the accessories and auxiliary equipment.
  - The structure/lift shaft in which the lift will be installed will be supplied and erected by the Owner. Vendor shall furnish all the information required by the Owner to enable him to design the structure/lift shaft. Vendor's supervisor shall supervise the installation of inserts in the lift shaft and shall be responsible for the correctness of the civil work in this regard.
  - With each lift the Vendor shall supply a maintenance tool kit.
  - Quantity and Quality of service- Minimum recommended quantity and quality of service shall be as per NBC (Latest version).

### 11.3 DESIGN FEATURES

- a. The design of the equipment offered should meet the following criteria: -
  - Usage of the latest state of the art technology
  - Design enhancements should not reduce the life cycle of equipment / components
  - Design life of at least 20 years
  - Highest levels of reliability& equipment availability
  - Lowest maintenance cost
  - Modular design
  - Minimum life cycle cost
  - High traceability of components through unique bar coding / serial nos. / tagging
  - Lowest energy consumption
  - Highest levels of safety
  - Environment friendly
  - Code compliance
- b. The landing doors shall be of the weather proof type when lifts are used in outdoor locations.
- c. All electrical devices like contactors, push buttons, indicating lamps located outside the machine room shall be housed in dust tight/water tight enclosures.
- d. Special care and precautions shall be taken regarding the hanging of lift cable loops between the points of suspension as the loops are prone to twist/distortion. Passenger lifts with travels above 30 metres shall comply with the following additional requirements.
- e. Cable anchorages; both on lift well and car; shall have adjustment facilities for the rotation of each cable to eliminate the accumulated twist without disturbing or disconnecting the cables.
- f. All the controls and interlocks shall be executed in microprocessor-based circuits.
- g. Lifts required to be installed in corrosive areas shall comply with the following additional requirements.
- h. All electrical devices shall be provided with enclosures.
- i. Copper or copper bearing material shall not be used in parts exposed to the atmosphere.
- j. Lift ropes shall be made of stainless steel.
- k. Lifts required to be installed in hazardous areas shall comply with the following requirements.

- l. All electrical devices mounted outside the machine room shall be housed in enclosures.
- m. Lift shall be provided with emergency lighting & alarm bell in each cab through car mounted dry cell rechargeable battery with minimum 5 years life expectancy & solid-state battery charger, necessary changeover relays.
- n. Provision of additional weight for interior finishes shall be kept for passenger & capsule lift. In case interior finishing materials in cab exceeds this provision, then the lift Vendor shall clearly identify the loss of carrying capacity, if any. Recess in platform of 20 - 25 mm shall be provided in floor for receiving stone flooring in the passenger lift.
- o. In addition car lighting will be connected on the emergency lighting UPS system. Location of light fixture to be coordinated with architects \ Interior Designer. Light output shall be minimum 100 Lux at floor level. Fully automatic operation of the lighting & ventilator fan inside the car shall be provided to put off the lights/ fan in idle condition.
- p. For overhead height, pit depth, car size with respect to lift well size, lift entrance size, passenger & load carrying capacity of different types of lifts based on their application, speed criteria, machine dimensions in case of lifts with machine room refer National Building code of India (NBC) – Part 8: Building Services, Section 5: Installation of Lifts & Escalators.
- q. For machine room less lifts which include normal & capsule lifts the specification, finishes, dimensions shall be finalised together in consultation with Owner, Architect & lift Vendor.
- r. Fireman's lift shall be as per local fire safety Regulation & Decision for the Requirement of the same shall be taken from fire safety Spector.
- s. The fireman's lift shall have the following minimum requirements:
  - Lift car shall have floor area of not less than 1.44 square meters. It shall also have a loading capacity of not less than 544 kg (8 persons).
  - Lift landing doors shall have a minimum of fire resistance of one hour.
  - Doors shall be of automatic operation for car and landing.

#### **11.4 MACHINE EQUIPMENT**

- a. Hoisting machines shall be gearless type for speed more than 1 m / sec and geared type for speeds of 1 m/sec or lower unless otherwise specified.
- b. Geared hoisting machine shall be single worm geared traction type with AC induction or P.M.S.M. AC VVVF motor, brake, gear, drive shaft, gear case and case and deflector sheave assembled & compactly mounted on a continuous



- bed-plate and set on steel beams. Sound isolating pads shall be installed beneath the machine bed-plate to reduce vibration or air borne noise.
- c. Gearless hoisting machine shall be AC induction or P.M.S.M. ACV3F gearless traction type motor with brake, drive sheave, and deflector sheave assembled & compactly mounted on a continuous bed-plate and set on steel beams. Sound isolating pads shall be installed beneath the machine bed-plate to reduce vibration or air borne noise.
  - d. The motor shall be reversible type particularly designed for lift service with high starting torque and low starting current. Sound reducing material shall be installed under machine.
  - e. Hoist machine mounted direct drive shall be provided with digital, closed-loop velocity encoder. Hoist machine drip pans shall be provided to collect lubricant seepage if required. Ladders and platforms with handrails and toe boards shall be provided for overhead sheave access within the bounds of the machine room.
  - f. Requirements for permanent lifting hooks hoisting beams and access hatches shall be indicated on the drawings by the lift system Vendor.
  - g. For Machine Room Less Type lifts AC induction or P.M.S.M. ACV3F gearless traction type motor with brake assembly, drive sheave, and deflector sheave mounted in proper alignment on a common, isolated machine support frame shall be provided at the top of the lift or mounted on the back of the guide rail at the top landing. The machine shall be located directly above the lift. Suitable beams shall be furnished for mounting deflector pulleys, if required by the lift Vendor. The break-release mechanism shall be operable from the last landing without entering into the lift.
  - h. The motor shall be reversible type particularly designed for lift service with high starting torque and low starting current. Starting current shall not be more than 2.5 times the normal current. All drives shall be rated for not less 150 starts per hour. The processor shall control the drive motor speed through pre-calculated acceleration and deceleration references for achieving smooth rides. The controller should achieve maximum inter floor speeds.
  - i. Sound reducing material shall be installed under machine. Hoist machine mounted direct drive shall be provided with digital, closed-loop velocity encoder.
  - j. Ladders and platforms with handrails and toe boards for overhead sheave access within the bounds of the machine room.

#### **11.5 EMERGENCY CRACKING**

- a. The hoisting machines shall be provided with a set of special tools including a hand crank to allow release of hoist brake and provide for manual movement of

the car in case of emergency. These tools shall be hung up on a tool board fitted to a wall in the lift machine room, with instructions for their use clearly written on the board both in English and the local language. The lift system Vendor shall qualify his bid with respect to manual cranking. An automatic switch shall be provided to interrupt power to the lift mains. Upon withdrawal of crank and manual resetting of power monitor switch, power shall be restored.

- b. In case of machine room less type lifts, emergency cranking shall be a part of lift control panel.

#### **11.6 SPEED GOVERNOR**

- a. The car safety shall be operated by a mechanical centrifugal type car & counterweight driven speed governor located in the upper part of the lift well for both lifts with or without machine room. The governor shall actuate a switch when excessive descending speed occurs, disconnecting power to the hoist motor and applying the brake prior to deployment of the safety.
- b. Power Conversion and Regulation Units for direct-current power for the operation of hoist machine brake, door operator, dispatch processor, signal fixtures, etc.\ solid-state, alternating current, variable voltage \ variable frequency (ACV3F), I.G.B.T converter/inverter drives \ controllers. Units shall be design to limit current, suppress noise, and prevent transient voltage feedback into building power supply, suppress solid-state converter noises, radio frequency interference, and eliminate regenerative transients induced into the mainline feeders or the building standby power generator.
- c. Direct drive, solid-state, digital type encoder shall be provider to update car position at each floor and automatically restore the same after power loss.
- d. Note - All lift equipment including their supports and fastenings to building, shall be from the building structure minimize objectionable noise and vibration transmission to car, building structure, or adjacent occupied areas of building. Noise level relating to lift equipment operation shall not exceed 60 dBA. @ 1 mtr.

#### **11.7 LIFT MATERIALS**

- a. Lift materials shall be non-flammable except traveling cable which shall be flame resistant. All other electrical cables shall also be flame resistant and housed in metal conduit or other metal enclosures.
- b. Guide Rails: Steel guide rails shall be installed to guide the car and counterweight, erected plumb and securely fastened to the building structure, fitted to ensure smooth joints. The guide rail shall be minimum 16 mm, tongued and grooved type.

- c. Buffers: Oil or spring type buffers shall be provided in the pit in compliance with ANSI/ASME/CENEN-81 or local code if more stringent. Clearance from underside of car resting on a fully compressed buffer shall be not less than 1.20m. Buffer shall be designed for design speed + 15%. The oil buffers shall be self-resetting type and shall be provided with means for determining the oil level. Switch shall be provided on buffer to limit car speed if buffer is compressed Ladder(s) and platform(s). It shall be provided buffer access.
- d. Oil buffers shall be provided for the passenger lifts for speed of more than 1.5 mps. and for Machine room less lifts for all speeds. The normal operation of the lift shall depend on the return of the buffers to their normal extended position after operation. The device for checking this shall be an electric safety device mounted on the buffers.
- e. Car: A car-frame fabricated from formed or structural steel members shall be provided with adequate bracing to support the platform and car enclosures. The car safety shall be integral with car-frame or shall be mounted on the bottom members of the car-frame and shall be of the flexible guide clamp type designed to stop and hold a fully loaded car which exceeds descending speed. Safety shall conform to ANSI/ASME/CENEN-81 or local codes if more stringent. The car platform shall be of Aluminium/ Stainless steel plate as per architectural requirement. The entire platform shall rest on rubber pads, so that it will be designed to form an isolating cushion between the car and car frame. Platform deflection shall be limited to maximum 3 mm under maximum normal operating conditions. In case of service lifts, the platform shall be provided with slip resistant Aluminium/Stainless Steel chequered plate flooring. The platform shall be arranged to accommodate one-piece load of mechanical / electrical equipment, etc. For servicing the car mechanical hatch to be provided as per design of lift Vendor.
- f. Car Top Station: A car top operating station shall comprise of key operated switch and constant pressure up/down buttons which shall be provided on each lift. Car shall respond to up/down command at inspection speed. The lift Vendor shall provide light fixture of 36 watt enclosed fluorescent or enclosed 2 x 18 Watt compact fluorescent switched from car top station.
- g. Counterweight: A structural steel frame with cast iron or steel plate filler weights shall be furnished to provide proper counterbalance for smooth operation.
- h. Counterweight: A metal counterweight guard shall be furnished and installed at the bottom of the lift and shall wrap around counterweight rails for a height of no less than 1.80 m in order to protect accidental contact.

- i. Sheaves: Sheaves shall be machined grooves, balanced and shall maintain cable /sheave ratio well within requirements. Lubrication points shall be extended to a location that is easily accessible. No deflector sheaves to protrude into lift.
- j. Lift & Governor Ropes: Lift ropes shall be traction steel of size, construction and number to insure proper operation of the lift and give satisfactory and safety assurance. Governor ropes shall be steel or to suit Vendor's specifications. All ropes shall consist of at least eight strands wound about a hemp core center. All ropes shall conform to ANSI/ASME/EN-81 or more governing codes or regulations. The minimum factor of safety for ropes shall be 10.
- k. Compensating Rope: Compensating ropes shall be furnished and installed for all lifts with speed over 2.0 m/sec, and travel in excess of 30 m, to compensate for the shifting weight of the hoist ropes. A device shall be provided to tie the car and counterweight together to limit the jump of the car or counterweight. Compensating chain where provided shall be enclosed in a plastic flame-resistant jacket to minimize noise.
- l. Lift Operating Devices: Redundant series wired terminal stopping devices shall be provided to slow down and stop the car automatically at the terminal landings. Resetting a tripped device shall be done manually only.
- m. Pit Switch: An emergency stop switch shall be located in the pit which when operated shall stop the car regardless of position in the lift.
- n. Travelling Cables: Travelling cable shall be secured to the cars underside. Cable shall be clear of all obstructions while car is in motion. Rubbing or chafing of cables against hoist-way or equipment within hoist-way to be avoided. Lighting & power cable shall be with Fire retardant outer sheath. Shielded wires and cables shall be provided for music, car access control, phone, TV, etc. Twisted type, 4 pair 14/0076 music cables and 4 pair 0.5 dia. Cat 3 cable for communication system shall be used. Travelling cables shall be flexible and suspended to relieve strain on individual conductors. A minimum of 10% spare conductors shall be provided in travelling cable.
- o. Wiring: All wiring and electrical interconnections shall comply with governing codes. Wiring shall 1100volt grade LSZH type and shall run in metal conduit, tubing or approved electrical raceways.

## **11.8 LIFT ENTRANCES & CAR DOORS**

- a. All landing lift entrance door shall have center opening horizontal sliding type doors unless otherwise specified suitable for a clear opening for each type of lift and shall include flush doors of hollow metal construction, extruded aluminium sill with anti-slip grooving and hanger supports and hanger cover shall be provided.

Exposed surfaces of doors and frames shall be finished as directed by the Interior Designer.

- b. Sheave type two-point suspension ball bearing door hangers and tracks shall be furnished for each lift opening. Sheaves shall not be less than 58 mm diameter and adjustable ball bearing rollers shall take the up thrust of the doors.
- c. Lift Entrances to have minimum two-hour fire protection. Complete entrances bearing fire labels from a nationally recognized testing laboratory approved within the governing jurisdiction.
- d. Car doors shall, unless specifically stated, be center parting, automatic power operated, variable frequency door operator or PWM DC door operator and electronic door detector. Infrared light beams covering full height & width of entrance shall be provided to act as a safety curtain across the door entrance to monitor the door closing.
- e. Car doors shall be hung plumb and even, to within 1 mm. with minimum number of 4 gibbs per leaf. Floor gibbs shall be well fitted so as to prevent popping noise as a car passes structural members, or car in motion in a shared shaft, etc. Lift doors shall be hung plumb and show a maximum of 6 mm joint at sides, top and bottom and 2 mm at centre joint. Narrow door frame or jamb panel shall be supplied by lift Vendor. A soft chime shall ring prior to doors closing and opening.
- f. In normal condition, Car cannot move when the car or hoist-way door is open. During emergencies, car and hoist-way doors shall be capable of being opened from outside.
- g. Frames: 14-gauge hollow metal at all floors. Door Panels: 16-gauge steel, sandwich construction without binder angles. Leading edges of center-opening doors shall be provided with rubber astragals. Each car & lift door leaf shall be fitted with minimum of two (2) gibbs per panel, one at leading and one at trailing edge with gibbs in the sill groove entire length of door travel. Sight Guards: 14-gauge, same material and finish as lift entrance door panels. Construct without sharp edges.
- h. Sills: Extruded aluminium.
- i. Sill Supports: Structural or formed steel shall be designed to support door sill based upon car loading classification.
- j. (Struts and Headers: Vertical support shall be provided of entrances and related material with door open bumpers on entrances equipped with vertical struts.
- k. Upon the car reaching landing in response to a hall or car call, a soft chime in the car shall sound. Door opening shall commence when the car is 25 mm from the levelling. Door open period shall be adjustable to within a range of + 1 second. Door-open-period on all floors except lobby floor shall be shortened to the extent

that door closure will commence 2 seconds (field adjustable) following the sensor beam interruption by the last boarding or disembarking passenger. This period shall be adjustable to 1.5 seconds  $\pm$  1.0 seconds. Normal door-open-period at lobby floor shall be monitored by the car's CPU. Door closure shall override "door-open-period" where car loading has reached by pass limit, or when another car approaches the lobby floor.

- I. An approved positive interlock shall be provided for each lift entrance which shall prevent operation of the lift unless all doors for that lift are secured and shall maintain the doors in their closed position while the lift is away from the landing. Emergency access to the hoist-way as required by governing codes shall be provided.
- m. Car and Hoist-Way Door Operator: For each lift door, an electric VVVF door operator or PWM DC door operator shall be furnished to simultaneously open the car and hoist-way doors when the car is at a landing. The doors shall be closed simultaneously by motor power. Emergency key provision shall be made to open doors at all landing from outside of the hoist-way. In the event of interruption of electric power or failure of the door operator, it shall not be possible to open the car door manually from within the car. An electric contact for the car door shall be provided which shall prevent lift movement away from the landing unless the door is in the closed position. Each hoist-way door shall be equipped with a positive electromechanical interlock and auxiliary door closing device so that the lift can be operated only after the interlock circuit is established. The doors shall open automatically while the car is levelling at the respective landing. The doors shall automatically close after a predetermined time interval has elapsed, but the momentary pressure of the "door open" button provided in the car shall reverse the motion and reopen the doors and reset the time interval unless overridden by the electronic door monitor.
- n. Door operation shall be consistent, smooth and quiet at all floors, regardless of door weight or varying air pressure.
- o. Door Control Device: Photoelectric door monitors shall be installed on each lift with full screen infrared matrix or multiple beams extending vertically along leading edge of each door panel to full height of door above finished floor. This device shall prevent doors from closing and reverse doors at normal opening speed if beams are obstructed while doors are closing, except during nudging operation. In event of device failure, provide for automatic shutdown of car at floor level with doors open. After beams of door control device are obstructed for a predetermined time interval (minimum 20.0 - 25.0 seconds), warning signal shall sound and doors shall attempt to close with a maximum of 1 kgm kinetic

energy. Activation of the door open button shall override nudging operation and reopen doors. When beams are interrupted during initial door opening door shall be remain open for minimum of 3.0 seconds. When beams are interrupted after the initial 3.0 second hold open time, hold time will reduce to 1.0 -1.5 seconds and which is adjustable.

- p. All lifts shall be equipped with automatic lift retrieval system which shall, upon signal from the central fire alarm system or manually operated key switch, cause all lifts to be dispatched automatically to the ground floor. Lifts shall, open their doors and remain at the ground floor. All floor and car buttons shall be rendered ineffective until the system is manually reset. A smoke detector shall be placed in close proximity to each lift bank on the ground floor. If this device senses smoke, system shall land lifts at a preselected, alternate, landing floor. A key operated switch shall be provided at the ground floor to activate and reset the retrieval system manually.
- q. Emergency operation shall return the lift/s to a designated floor, most commonly, the Lobby, by means of a signal from the automatic fire alarm system.
- r. On initiation from the fire alarm system, control panel, all lifts travelling away from the lobby floors shall stop and reverse without opening their doors indicating fire mode-operation to passengers, ignoring all car and hall calls and express to the lobby or assigned floor.
- s. Cars travelling toward ground shall express to ground ignoring all car and hall calls. Cars parked on intermediate floors shall close their doors and express to ground. Cars parked at lobby shall open their doors ignoring car and hall calls. All hall and car buttons shall extinguish and shall accept no further hall or car registration.
- t. All lifts shall, in addition and where allowed by code, be provided with a key operated switch for use by in-house fire brigade.
- u. The lift Vendor shall coordinate and cooperate with the fire detection & alarm system supplier / installer for his system interfacing responsibilities.

#### **11.9 FIREMAN EMERGENCY**

- a. Actuation of fire mode shall put all car functions as described here under fireman control by means of a key switch.
- b. Hall button giving car call indication shall cause the doors to close.
- c. Applying constant pressure to the door open button shall cause door to begin to open. Releasing the button before door is fully open shall cause the door to close.
- d. Hall buttons shall be rendered inoperative.

- e. Car position indicator shall indicate floor when car is within door operating range, and if in motion it shall indicate nearest floor by flashing. When a car is within operating zone, the position indicator shall light uninterrupted.
- f. All electrical door safety locks shall remain effective.
- g. Car position, direction of travel and floor conditions shall be displayed on the car position monitor in the lobby, and at lift system monitor in engineering room.
- h. Returning the car to the designated landing floor, deactivating the lobby switch shall render the car to original pre-fire mode condition.
- i. Resetting the Fire Alarm contacts in the car monitoring panel shall restore the system to normal condition.
- j. A switch shall be provided in the car to permit operation of the lift from top of the car for inspection purposes, with car and hall buttons inoperative. Car shall travel at inspection speed not exceeding 0.5 m/sec. Motion of car shall require constant pressure to directional button.
- k. A key operated switch shall be provided in the car operating station which, when actuated, shall disconnect the lift from the hall buttons and permit operation from the car buttons only.
- l. Lift control panel (ECP) shall be vertical, totally enclosed cubicle constructed of sheet steel with hinged doors on the front and screwed panels or hinged doors on the back, giving easy access to all components inside the controller. The cubicle enclosure shall be minimum of IP 22. Panel Ventilating fans shall be provided to maintain components temperature within limits.
- m. It will have a microprocessor with solid state switching devices sequenced and interlocked It will have monitoring points for Lift position & Emergency Stop ECP should be located such that it can be easily accessed from the last landing and shall be key locked and vandal proof.
- n. It will provide protection but not restricted to the following:
  - No-voltage or sustained under voltage
  - Overcurrent in any component
  - Phase reversal of the power supply
  - Overload
  - Single phasing
- o. ECP shall be arranged to cut-off the power supply, apply the brake and bring the car to rest at the nearest landing in the event any of the above failures occur. Same should happen, in the event of a signal from the Fire Alarm Control Panel.
- p. Transducers in the car platform shall monitor passenger load which shall override “pre-programmed door open period” and dispatch the loaded car from the low terminal. The load weighing device shall also function in the same manner on all



- intermediate and top floors and in addition shall express to the next car call and ignore all hall calls. Hall calls which are bypassed shall not be cancelled. The automatic load bypass device shall be field adjusted for 50% - 75% of rated load.
- q. Any modification in the civil works required shall be clearly brought out by the Bidder. No extra claims will be entertained on this account at a later date.
- r. The lift control system shall have a Fire Alarm signal accept facility, if specified in Data sheet. The 'lift recall' function shall be activated in the receipt of such a signal & lift car shall halt on the specified floor with their doors opened.
- s. The lift control system shall have a RS 232 / RS 485 interface, if specified in Data sheet for connecting to the Building Automation System. Adequate number of NO / NC contacts need to be provided in the lift control system for indicating the position of lift car in a remote location.
- t. Push to talk facility-
- Each lift shall be fitted with an intercom system to allow at least 3-way, hands free, conversation between the lift car, machine room & two remote stations.
  - The microphone & speaker unit shall be concealed behind the COP in the lift car & is activated by pressing the button which has an indication glowing when intercom is in operation. The master unit in the remote stations has to have an indicator for each lift.
- u. Provision for Handicapped Persons:
- Lift control buttons & Hall call buttons shall be provided at locations and height specified in IS 15330 – 2003.
  - Braille notations indicating the floor levels shall be incorporated next to each button at the Car operating panel (COP) and hall call buttons.
- v. Handrail: At least on one side wall of the car a handrail shall be installed. The gripping of this handrail shall have a minimum circumscribed diameter of 30 mm and a maximum of 45 mm. The free space between the wall and the gripping part shall be at least 45 mm. The height of the top edge of the gripping part shall be within 900 mm+ 0/-25 mm from the finished car floor level. The handrail may be interrupted where the car operating panel is located in order to avoid obstructing buttons or controls.
- w. Mirror: Where a passenger in a wheelchair is unable to turn around, a device to observe obstacles when moving backwards out of the car shall be installed, for example a mirror installed in an appropriate position. Where glass is used as mirror it shall be of a laminated safety glass. The lowest part of the mirror should be a minimum of 300 mm from the floor.

- x. Voice Synthesizer(Digital type): A digital voice system for announcing the car position, opening/closing of doors, direction of travel and messages shall be provided as per IS: 15330 – 2003.
- y. Following messages in at least two languages per Client requirement to be provided;
  - Arrival at the floor & its designation.
  - Lift failed to start, please press the door open button
  - ARD operation
- z. The Elevator Panel should have the following Provisions:
  - It shall be able to accept signal from the Fire Alarm Panel in case of fire and automatically ground the elevator on receipt of this signal.
  - Potential free contact to indicate elevator trip status.
  - Potential free contact to indicate elevator alarm status.
  - Potential free contact to indicate Emergency Activation Switch status.
- aa. FAS Vendor shall provide necessary cabling up to Elevator Panel and termination shall be done by Elevator Vendor. For integration with PA System, additional cabling to be provided from lift car to the Lift machine.
- bb. Software Interface: The Lift microprocessor panel should be compatible with BAS and should be able to communicate with the BAS in any of the following standard protocol like MODBUS, LANWORKS, BACNET etc. In case of multiple lifts having individual microprocessor panels it should be possible to network all microprocessors panels and be connected to a master controller. BAS communication cable can be integrated directly to the master controller or in case master controller is not available it should be possible to integrate each Microprocessor controller to the BAS system. It should be possible to monitor the following data points through software integration.
  - Elevator car position.
  - Fire Emergency signal monitoring.
  - Elevator Attendant Mode.
  - Elevator Alarm Mode.
- cc. In case of fire it should be possible to control the lift through software interface. All necessary hardware including interface card and accessories necessary for integration with the BAS system has to be provided by BAS Contractor.

#### **11.10 TESTS ON COMPLETION**

- a. The following tests shall be carried out to the satisfaction of the EPI/CDRI.
- b. Insulation resistance and earth test for all electrical apparatus.

- c. Continuous operation of the lift under full load conditions and simulated starts and stops (150 nos. per hour each) for one hour at the end of which time the service temperature of the motor and the operating coils shall be tested. This shall be as per B.I.S. specification.
- d. The car shall be loaded until the weight on the rope is twice the combined weight of the car and the specified load. The load must be carried on for about 30 minutes, without any sign of weakness, temporary set or permanent elongation of the suspension rope strands.
- e. The following items shall be tested:
  - Levelling accuracy at each landing in conditions of fully loaded and empty car.
  - No load current and voltage readings both on 'Up' and 'Down' Circuits.
  - Full load current and voltage readings both on 'Up' and 'Down' Circuits.
  - One and quarter load current and voltage readings both on 'Up and 'Down' Circuits.
  - Stalling current and voltage and time taken to operate overload.
  - Overload protection.
  - Gate sequence relays, if provided and installed.
  - Car and landing door interlocks.
  - Collective control and priority sequences, if installed.
- f. Safety gear mechanism for car and counterweight with fully loaded car and also with only 68 kg load.
- g. Speeds on Up and Down travel with full load, half load and empty car.
  - Door contacts.
  - Final terminal stopping device.
  - Normal terminal stopping device.
  - Car and counterweight buffers with contract load and contract speed.
  - Operation of controllers.
  - Manual operation of lift at mid-way travel.
  - Emergency operation.
- h. Tests on completion shall also be performed to the satisfaction of Inspector of Lifts and a certificate will be obtained from the 'Lift Inspector' by the contractor.
- i. The test certificates for the following would be required before handover:
  - Hoist ropes
  - Governor ropes
  - Over speed governor
  - Buffers

- Main motor & Door drive motor
- Safety gear
- Fire rating for doors
- Controller

### **11.11 SAFETY ITEMS**

- a. Following safety items shall be provided in each machine room / Lift;
  - First Aid Box
  - Co2 / foam-based fire hydrant cylinders
  - Danger Plates
  - Rubber mats in front of each controller
  - Electric shock treatment charts
  - Any other safety item that may be required by authorities.
- b. Contractor to cover the cost of these items in his quoted rates, nothing extra shall be paid on this account.

## **12 ILLUMINATION SYSTEM**

### **12.1 GENERAL REQUIREMENTS**

- a. The Lighting system shall include Design, Supply, Installation, Testing & Commissioning of the following items:
  - Lighting fixtures complete with lamps and accessories
  - Lighting system equipment (ISI make)
  - Light control switches, receptacle units with control switch units, lighting wires, conduits and other similar items necessary to complete lighting system
  - Lighting fixture supports, street lighting poles
  - Main lighting distribution board, lighting panels, receptacle panels
  - Multi core cables for street, boundary and flood lighting
  - PVC Conduits
  - Load balancing of lighting system shall be made

### **12.2 DESIGN**

- a. The lighting system design shall comply with the acceptable norms and the best engineering practices. The lighting layout shall be designed to provide uniform illumination with minimum glare. The layout design shall meet all the statutory requirement, local rules etc.

- b. The value of the ratio of spacing (S) to mounting height (H) shall be commensurate with the type of fittings selected and uniformity of illumination.

### 12.3 APPLICABLE CODES & STANDARDS

- a. All standards and codes of practice referred to below shall be the latest edition including all official amendments and revisions.

**TABLE- 3 Applicable Standards**

Sr. No.	Brief Title	IS/IEC Code
1.1	Testing procedure of photometric testing for LED luminaires	LM 79
1.2	Testing procedure on the lifespan of LEDs	LM 80
1.3	National Lighting Code	SP72
1.4	Method of Measurement of Lumen Maintenance of Solid-State Light (LED) Sources	IS:16105
1.5	Method of Electrical and Photometric Measurements of Solid-State Lighting (LED) Products	IS:16106
1.6	Limits of Harmonic Current Emissions	IS 14700-3-2
1.7	DC or AC supplied electronic control gear for LED modules performance requirements	IEC 62384
1.8	Lamp control gear: particular requirements for DC or AC supplied electronic control gear for LED modules	IEC 61347-2-13
1.9	Environmental Testing: Test Z- AD: composite temperature/ humidity cyclic test	IEC 60068-2-38
1.10	Electro Magnetic compatibility (EMC)- Limits for Harmonic current emission-- (equipment input	IEC 61000-3-2

Sr. No.	Brief Title	IS/IEC Code
	current $\leq$ 16 A per phase)	
1.11	EMC Immunity requirement	IEC 61547
1.12	LED modules for general Lighting-Safety requirements	IEC 62031
1.13	Classification of degree of protections provided by enclosures (IP Codes)	IEC 60529
1.14	Fixed general purpose luminaires	IEC 60598-2-1
1.15	General Lighting - LEDs and LED modules – Terms and Definitions	IS:16101 / IEC TS 62504
1.16	LED Modules for General Lighting Part 1 Safety Requirements	IS:16103(Part1)
1.17	LED Modules for General Lighting Part 2 Performance Requirements	IS:16103(Part2)
1.18	Safety of Lamp Control Gear, Part 2 Particular Requirements Section 13 D.C. or A.C. Supplied Electronic Control gear for Led Modules	IS:15885(Part2/Sec13)
1.19	3 pin plugs & sockets	IS 1293
1.20	General safety requirements for luminaires	IS1913
1.21	Luminaires for street lighting	IS 10322(PART-5,S3)
1.22	Fitting for rigid steel conduits for electrical wiring	IS 2667
1.23	Code of practice for interior illumination	IS 3646 & IS 6685
1.24	Switches for domestic & similar purpose	IS 3854
1.25	Electric ceiling type fans & regulator	IS 374
1.26	Code of practice for electrical wiring installation (system voltage not exceeding 650Volts	IS 732

Sr. No.	Brief Title	IS/IEC Code
1.27	General lighting LED and LED Modules	IS 16101
1.28	Self ballast LED lamps for general lighting services	IS 16102(PART-1&2)
1.29	LED modules for general lighting	IS 16103 (PART 1 & 2)
1.30	Safety of lamp control gear	IS 15885 ( PART-2/SEC-13)
1.31	DC or AC supplied electronic control gear for LED modules	IS 16104
1.32	Method of measurement of lumen maintenance of solid-state light (LED) sources	IS 16105
1.33	Method of electrical and photometric measurements of solid-state light (LED) products	IS 16106
1.34	Luminaires performance	IS 16107 (PART-1& 2)
1.35	Photo biological safety of lamps and lamp system	IS 16108

#### **12.4 LED LUMINAIRES**

- a. LED luminaires shall be used for internal & outdoor lighting. Luminaires shall be installed to permit ease of maintenance. The Contractor shall provide all equipment necessary to carry out maintenance on the lighting installation and demonstrate its operation to the satisfaction of the Engineer.
- b. MCB (DP for single phase MCB and 4P for three phases MCB DB) and DP RCCBs for each phase shall be provided at the incomer of Lighting panels and SP MCB for outgoing feeders.

#### **12.5 LIGHTING SYSTEM**

- a. Indoor & Outdoor Luminaire Description

- The Luminaires shall have a sturdy and corrosion resistant high pressure Die cast Aluminium housing with weatherproof gasket for lamp and control gear accessories. The Housing shall be Epoxy coated, without any cracks or thorough holes, made in a single piece of die-cast LM6 aluminium alloy. The luminaries shall be totally enclosed, dust tight and water proof.
- Heat sink used should be aluminium extrusion having high conductivity. The dimensions of luminaries shall be optimum and adequate to permit sufficient heat dissipation, through the body itself, so as to prevent abnormal temperature rise inside the lantern and consequential damage to the cover and gasket materials, LEDs, lenses and electronic drivers. Heat sink must be thermally connected to MCPCB/ LED light source.
- The Luminaries Housing shall be suitable for termination of Cable with Double Compression Cable Glands.
- Luminaires should conform to the photometric Distribution / requirements of Cut-Off / Semi Cut – off light distribution and optics as classified in IS 1944.
- Suitable number of LED lamps shall be used in the luminaries. The manufacturer shall submit the proof of procurement of LEDs from OEMs at the time of testing.
- An extruded silicon loop gasket shall be provided in the lantern body to ensure a weather proof seal between the cover and the metal housing to exclude the entry of dust, water, insects, etc. Luminaries should conform to degree of protection of IP 66 or above. Felt gasket will not be accepted.
- Year of Manufacture, Batch No., Serial Number or Identification No. Luminaries Manufacturer's Name / Logo, Wattage and Frequency should be embossed on the housing.
- LED luminaries should conform to the various National / International standards for safety & performance. Manufacturer should provide test reports as per LM 79 & LM80. Lumen maintenance report as per LM 80 guidelines shall be submitted for the LEDs used along with the BID.
- Luminaries should conform to the IS standards for Safety & Performance and test certificates as per IS 16107 should be provided by the manufacturer. In case of luminaries are imported, the Bidder shall conform to test parameters as per UL or equivalent standards.
- The electrical component of the LED and LED driver must be suitably enclosed in sealed unit to function in environment conditions mentioned earlier.
- All the connecting wires inside the Luminaries shall be low smoke halogen free, fire retardant cable.



- Adequate protection against Overloading, Short Circuit, Over Voltage, over temperature, Under Voltage, String Open shall be provided within the Luminaries.
  - Design of the thermal management shall be done in such a way that it shall not affect the properties of the diffuser.
  - The equipment should be compliant to IEC 60598-1, IEC 62031 and IEC/PAS 62612 depending on the type of luminary.
  - All the material used in the luminaries shall not contain any toxic material/ metal like mercury; shall be halogen free and fire retardant confirming to relevant standards.
  - The Manufacturer shall have all the relevant testing facilities certified by an accredited laboratory and shall be offered for inspection to the Owner for verification of the required parameters and tests. Bidder shall confirm the same in the Bid.
  - The control gear shall comply to the provisions of IEC 61347-2-13, IEC 62031 and IEC 62384 as appropriate.
- b. The post top decorative light fixture shall be mounted on MS pole with PU paint. The thickness of the paint shall be 80-90 micron. The colour for the paint shall be as per direction of Engineer-in-charge..
  - c. Two nos. 50 mm NB HDPE Sleeves of suitable length shall be provided through the foundation upto the Junction Box for entry of power cable.
  - d. All the material/equipment/accessories shall be supplied with manufacturer's test certificates.
  - e. Bidder shall submit the Proposed Product Catalogue, Detail Data sheet, spare parts list and drawing of Bracket along with the BID for each product quoted.
  - f. Testing of Luminaire
  - g. The Routine test on each of the offered Luminaire shall be carried out by the Bidder before dispatch. Following tests shall be carried out as routine tests by the Bidder for the offered Luminaries:
    - Visual and Dimensional check
    - Checking of documents of purchase of LED
    - Insulation resistance test
    - HV test
    - Reverse polarity
  - h. The Acceptance test shall be carried out by Owner or Owner's Representative on a sample of the lot offered for Acceptance. The Lot shall be different from the lot from which the Type test samples have been drawn. The cost of the testing shall





be borne by the Bidder. Following tests shall be carried out as Acceptance tests by the Bidder for the offered Luminaries:

- Visual and Dimensional check
- Checking of documents of purchase of LED
- Insulation resistance test
- HV test
- Over voltage protection
- Surge protection
- Reverse polarity

**Table -4 Indoor Luminaire Data Sheet**

<b>Parameters</b>	<b>Requirements / Value</b>
Type	LED Luminaries complete with all accessories for recess mounting
Rated Voltage	240V
Operating Voltage Range	220-240 volt AC.
Frequency	50±3 Hz
Driver Type	Constant Current based Electronic Driver
Housing Material	Metallic CRCA Powder Coated Body/Extruded aluminum frame
Diffuser	PC Glossy/Opal PMMA
Mounting	Recess/Surface Mounted
Compatibility for Dimming	Yes
Optics	Symmetric
System Power Efficiency	≥ 85%
Operating Temperature Range	-20 C to + 50 C
Operating Humidity	10% to 90% RH
System efficacy	≥100 Lm/Watt; (≥65 Lm/Watt for flame proof fixture)
Colour Temperature	≥5500K.
LED Drive Current	>350 – <750 mA
Leakage	As per IEC 60598

Current	
LED Wattage	1-3 W
Power Factor	≥0.90
Colour Rendering Index	≥70
Rated Minimum LED Life	50,000 Burning Hours (With only 30% Lumen Degradation) ;(>40,000 for flame proof fixture)
Driver Life	>20000 Burning Hours
Maximum temperature rise for the Driver	≤ 30 Deg C from ambient
Heat Sink Temperature	≤ 15 Deg C from ambient
Total Harmonics Distortion (THD)	<10%; (<15% for flame proof fixture)
IP Protection	IP 20
IK protection for Optic Cover	>IK05
Photometric measurements	LM-79/IS16105.
Minimum Surge Protection	>3kV
Protection Required in Driver Module	
Short Circuit	Yes; Constant current limit mode.
Over Voltage	Yes;
Over Temperature	Yes; Auto Shut Off.
Under Voltage	Yes;
String Open Protection	Yes;
Model No.	Philips RC380B LED30S-6500 G5 L60 W60, DN295B LED12S PSU WH, DN296B LED15S PSU WH, DN296B LED20S PSU WH, TMC 501 P 1xT-LED 30W or equivalent

Luminaire Snap	 <p>Philips RC380B LED30S-6500 G5 L60 W60,</p>
Luminaire Snap	 <p>DN295B LED12S PSU WH,</p>
Luminaire Snap	 <p>DN296B LED15S PSU WH,</p>
Luminaire Snap	 <p>TMC 501 P 1xT-LED 30W,</p>
Luminaire Snap	 <p>TMC 501 P 1xT-LED 30W</p>

--	--

**Table – 5 Outdoor Luminaire Data Sheet for Building Lighting**

Parameters	Requirement
Type	LED Luminaires complete with all accessories for Outdoor Lighting
Make of LED	Cree/Nichia/Osram/Lumileds
Body of fittings	Pressure Die Cast Aluminium Alloy
System Wattage at maximum output, steady state	Minimum 140W
Luminaires capable for color changing	No
CRI	Minimum 70
Lumens Output	Minimum 15000 lumens
Operating voltage	100-270 V AC
Lumen maintenance L70 B10 at 25degree	50000 Hours @L70 50 Degree C
Operating Temperature	0 to+ 45 Deg Centigrade
Ingress Protection	IP66, IK>= 07
Mandatory Certification	Luminaire should be BIS certified.
Eficiency	Minimum 105lm/watt
THD, Power Factor	<10%, >0.9
Mandatory test reports	LM-79, LM80
Luminaire connectors	Weather proof IP rated connectors
Surge Protection	Minimum 5kV
Lens type	Tampered Glass
Model	Philips BVP122 LED 150 CW HE NB FG or equivalent

Luminaire Snap



--	--

**Table-6 Post Top Data Sheet for Gate Lighting**

Parameters	Requirement
Type	LED Luminaries complete with all accessories for Gate Lighting
Make of LED	Cree/Nichia/Osram/Lumileds
Body of fittings	Die Cast Aluminium
System Wattage at maximum output, steady state	Minimum 27W
Luminaries capable for color changing	No
Beam Angle	-
Lumens Output	Minimum 2500 Lumens with 3K Output
Operating voltage	100-240 V AC
Lumen maintenance L70 B10 at 25degree	50000 Hours @L70 50 Degree C
Operating Temperature	0 to+ 45 Deg Centigrade
Ingress Protection	IP65, IK 07
Mandatory Certification	Luminaire should be BIS certified.
Mandatory test reports	LM-79, LM80
Luminaire connectors	Weather proof IP rated connectors
Surge Protection	Minimum 5kV

Lens type	Tampered Glass
Model No.	Philips BGP161 LED2300/WW PSU 220-240V 7043 IN or equivalent.
Luminaire Snap	

## 12.6 Lighting Layout

- a. It shall be the responsibility of the Contractor to work out a detailed layout for the complete building in order to provide the levels of illumination as indicated in the relevant standards
- b. The types of fixtures to be used in various areas shall be also indicated in the above mentioned drawing.
- c. The Contractor shall be responsible for measuring the levels of illumination and uniformity after installation and establish compliance with the specification.

## 13 TECHNICAL SPECIFICATIONS FOR UNINTERRUPTED POWER SUPPLY UNITS

### 13.1 SCOPE

- a. Scope of this specification covers design, preparation of detailed drawings, manufacture, testing, inspection at manufacturer's/ vendors' works, supply, packing, forwarding and delivery from place of storage/ manufacturer's works to erection site including transit insurance, unloading, storage at site, assembly, erection, installation, testing, commissioning and performance demonstration of the UPS Systems mentioned below along with associated accessories and one set of spares recommended for specified no. of years of trouble free operation.

### 13.2 CODES AND STANDARDS

- b. The equipment shall fully comply with the requirements of enclosed specifications and the latest editions of codes and standards not limited to the following;

Safety Standard:	IEC/EN 62040-1-1 IEC/EN 60950-1
Electromagnetic Compatibility Standard (EMC)	IEC/EN 61000-6-4 IEC/EN62040-2 IEC/EN 61000-6-2 IEC/EN 61000-4-2 IEC/EN 61000-4-3 IEC/EN 61000-4-4 IEC/EN 61000-4-5 IEC/EN 61000-4-6
Performance Standard:	EN 62040-3

In the event of any conflict between the codes and standards referred to elsewhere in the specification and the requirement of this specification, latter shall govern.

### 13.3 UPS SYSTEM : SPECIFIC REQUIREMENTS

- a. For Desktop/ Workstation Load : UPS system suitable for 415V 3 phase 4 wire as input and three phase output 415V, 50Hz, 3phase 4 wire, in Parallel Redundancy configuration. Each UPS shall be capable of independent 30 minutes battery backup facility.
- b. For Emergency Illumination: UPS system suitable for 240V 1-Phase Input / 240V 1-Phase Output, Rack mountable UPS with 30 minutes backup.
- c. This specification describes the operation and functionality of a continuous duty, solid-state, true on-line double conversion static Uninterruptible Power System (UPS).

### 13.4 RECTIFIERS

- a. The rectifier shall be capable of supplying the inverter full load, in addition to recommended by battery manufacturer and then maintain the battery on trickle charge mode.



- b. Input Current Total Harmonic Distortion: The input current THDI shall be within limit while providing conditioned power to the critical load bus and charging the batteries under steady-state operating conditions. This shall be true while supporting both a linear or non-linear load. This shall be accomplished without the requirement for additional or optional filters, magnetic devices, or other components.
- c. Soft Start: The rectifier shall be provided with soft start feature. Same shall be linear from 0-100% input current and shall not exhibit inrush. This shall take place over a user selectable 1-60 second time period with a factory default of 10 seconds.

### **13.5 INVERTERS**

- a. The UPS output inverter shall constantly develop the UPS output voltage waveform by converting the DC bus voltage to AC voltage through a set of IGBT driven bi-directional power converters. In both normal operation and battery operation, the output inverters shall create an output voltage independent of the mains input voltage. Input voltage variation such as spikes, surges, sags and outages shall not affect the amplitude or sinusoidal nature of the output voltage sine wave of the inverters.
- b. Output Contactor: The output inverter shall be provided with an output mechanical contactor to provide physical isolation of the inverter from the critical bus. With this feature a failed inverter shall be isolated from the critical bus.
- c. Redundancy: The UPS shall be capable of being configured with redundant output inverters, each with semiconductor fusing, and logic-controlled contactors to remove a failed component from the input, DC and output critical bus.
- d. All UPS shall have IGBT technology for rectifier and inverter.

### **13.6 STATIC BYPASS**

- a. The static switch shall comprise thyristors connected in anti parallel configuration, enabling loads on each branch circuit to be connected to the inverter of the other branch circuit or to the stand-by regulated AC supply.
- b. The current rating of the static switch shall be not less than the continuous full load rating of the branch circuit and short time rating of 1000% for 20 milliseconds.
- c. System static bypass shall provide no break transfer of the critical load from the Inverter output to the static bypass input source during times where maintenance is required, or the inverter cannot support the critical bus.
- d. Automatic initiation of the transfer from a faulty branch circuit to either a healthy branch circuit or the stand-by regulated source shall be accomplished during following conditions :

- Inverter failure.
  - Loss of inverter AC output.
  - Load over current (in case of non-redundant UPS with static by pass to regulated supply).
- e. Automatic Transfers: An automatic transfer of load to static bypass shall take place whenever the load on the critical bus exceeds the overload rating of the UPS. Automatic transfers of the critical load from static bypass back to normal operation shall take place when the overload condition is removed from the critical bus output of the system. Automatic transfers of load to static bypass shall also take place if for any reason the UPS cannot support the critical bus.
- f. Manual Transfers: Manually initiated transfers to and from static bypass shall be initiated through the UPS graphical user interface.
- g. Discrete LED indicators integrated in mimic diagram or multi line alpha numeric text display unit shall be provided for continuous monitoring of the UPS operation. The UPS control system shall be fully compatible for remote operation via communication link. Contractor to indicate the type of communication protocol supported by the system along with the details of links provided in the system. The control system shall operate on Windows or eqvt. Platform. The following operating conditions shall be annunciated.

### **13.7 ALARM**

- System fault
- Rectifier charger failure
- Inverter failure
- Battery undervoltage
- Thyristor over temperature
- Fuse failure
- Over load
- Static transfer to stand-by
- Transfer inhibited
- Over load shutdown
- Emergency shutdown
- Battery circuit breaker / switch open
- AC Main failure
- AC stand-by source mains failure
- Manual bypass ON
- Fan failure
- Asynchronous condition
- Control power failure

- DC ground fault.
- Input Frequency outside configured range
- AC adequate for UPS but not for Bypass
- Number of Batteries changed since last ON
- Shutdown or unable to transfer to battery due to overload
- Load Shutdown from Bypass. Input Frequency Volts outside limits
- Fault, Internal Temp exceeded system normal limits
- Input Circuit Breaker Open
- Redundancy has been lost
- Redundancy is below alarm threshold
- Runtime is below alarm threshold
- Load is above alarm threshold
- Load is no longer above alarm Threshold
- Minimum Runtime restored
- Bypass is not in range (either frequency or voltage)
- Back feed contactor stuck in OFF position
- Back feed contactor stuck in ON position
- UPS in Bypass due to Internal Fault
- UPS in Bypass due to overload
- System in Forced Bypass
- Fault, Bypass Relay Malfunction
- High DC Warning
- High DC Shutdown
- Low Battery Shutdown
- Low Battery Warning

**13.8 Controls: The following controls or programming functions shall be accomplished by the use of the user interface/ display unit. The touch screen display shall facilitate these operations:**

- Silence audible Alarm
- Display or set the date and time
- Enable or disable the automatic restart feature
- Transfer critical load to and from static bypass
- Test battery condition on demand
- Set intervals for automatic battery tests
- Adjust set points for different alarms
- Potential Free (Dry) Contacts
- Status Indication on Mimic

- Mains on
- rectifier on
- Battery on load
- Inverter on
- AC Stand-by source on
- Inverter on –load
- Manual by-pass on
- Load on static by pass.
- Remote UPS monitoring shall be possible via MODBUS.
- Web Monitoring: Remote monitoring shall be available via a web browser such as Internet Explorer.

### **13.9 METERS**

- a. Meters shall be suitable for semiflush mounting with flanges projecting in vertical panels.
- b. Meters shall have circular 240 Deg scale, 110 mm square, moving coil (taut band) type, conforming to IS: 1248 with accuracy class 1.0 or better.
- c. The following meters shall be provided :
  - Voltmeter with selector switch to measure input voltage / stand-by AC supply.
  - Ammeter with selector switch to measure input current.
  - DC Volt meter for rectifier
  - DC Ammeter for rectifier
  - Volt meter for inverter output.
  - Ammeter for AC output and regulated stand-by AC.
  - Frequency meter for AC output of digital type.
- d. Alternatively an alphanumeric multi line display to indicate all the parameters listed above is acceptable.

### **13.10 CIRCUIT PROTECTION**

- a. The following devices shall be provided to protect the UPS system:
  - AC input circuit breaker to Rectifier unit.
  - DC circuit breaker for battery output.
  - Fast acting semiconductor fuses.

### **13.11 BATTERY SYSTEM**

- a. 12V, Lead Acid Sealed Maintenance Free (SMF) type battery, battery isolator & mounting stand shall be provided.

- b. Design Margin of 10% and Aging factor of 1.25% shall be considered for battery sizing calculations.
- c. First charging of the battery shall be carried out by the BIDDER.
- d. Batteries shall be provided with FR casing.
- e. Battery bank should be with 2 strings (100% x 2) per UPS with individual isolator/ protection for UPS
- f. In the event of a battery malfunction the affected string shall be automatically isolated from the system thereby ensuring battery autonomy is retained, albeit of a shorter duration.

**13.12 EARTHING**

- a. Dedicated Cu earthing shall be provided for UPS & isolation transformer neutral earthing.
- b. Body earthing shall be provided for UPS, Isolation transformer & battery rack.

**13.13 UPS SYSTEM TECHNICAL PARTICULARS**

**a. WORKSTATION UPS**

Sr. No.	Specifications	Requirement
1	Type	3-Phase Input / 3-Phase Output in Parallel Redundancy configuration. Each UPS shall be capable of independent 30 minutes battery backup facility.

2	Technology and Capability	<p>a) True Online configuration with double conversion UPS System</p> <p>b) DSP based technology with reduction in electronic components.</p> <p>c) Fully rated power (kVA=kW) for maximum power availability.</p> <p>d) Possibility of enhancing UPS capacity / redundancy by operating UPS in N+X Parallel Redundant Configuration (PRS).</p> <p>e) Capability of Independent or Common battery bank operation of the UPS when operated in PRS.</p> <p>f) UPS should be designed at Rated PF of 1.</p> <p>g) Dual Input design.</p> <p>h) UPS should have IGBT topology for both PFC (power factor correction) and inverter.</p> <p>i) Should have Dual Aux power design.</p>
3	Model Name & Number:	
	Make / Model / Part No to be specified by the vendor	
4	Input	
	Input facility - Phases / Wires	3-Phase / 4-Wire & Ground (3Phase & Neutral + Ground)
	Input Voltage	415V, 3 Phase, 4Wire
	Nominal Input Frequency	50 Hz
	Input Frequency Range	45 to 65 Hz
	Input Power Factor	> 0.99 (Full Load)
	Current Harmonic Distortion(ITHD)	< 3%
	Generator	Compatibility to Genset supply required

	Compatibility	
	Input Protection (Through In-built 1P MCB)	Should be provided at the input of the UPS suitable for the full rated capacity of the UPS
5	Output	
	Nominal Output voltage	415V, 3 Phase, 4Wire
	Output Voltage Regulation	$\pm 1 \%$
	Nominal Output Frequency	50 Hz
	Output Frequency Regulation	$\pm 0.05\text{Hz}$
	Output Frequency Slew Rate	$< 1\text{Hz/sec}$
	Output Wave Form	Pure sine wave
	Output Voltage Distortion (THDu)	$< 1.5 \%$ (linear load)
	Crest Factor	3:1
	Output Short circuit Protection	Electronic Protection
6	Transient Response / Recovery	
	Transient Response: Dynamic Regulation for 10% to 90% step linear load	$\pm 7\%$

	Transient Recovery to steady state condition after 10% to 90% step linear load	< 1 cycle
7	Transfer Time	
	Transfer Time of (Mode of operation)	Zero ms from Mains mode to Battery Mode Zero ms from Battery Mode to Mains mode
	Transfer Time (Inverter to Bypass / Bypass to Inverter)	<1ms (Synchronized Mode)
	Automatic & Bi-directional static by-pass (In-built)	Bypass to Inverter $\pm 10$ % (Rated Voltage) Inverter to Bypass $\pm 7$ % (Rated Voltage)
	Maintenance Bypass	1. UPS should have option for manual maintenance bypass 2. Maintenance bypass cover removal sensing. 3. The maintenance bypass should provide for Hot-swap of the faulty UPS PWB for repairs / service.
8	Efficiency (At Nominal Voltage & Resistive Load up to kW rating of UPS)	
	Overall Efficiency (AC to AC) - Online (Double Conversion)	Upto 93%
	Overall Efficiency (AC to AC) - ECO Mode (Bypass feeding the load under normal conditions)	Upto 96%



9	Overload	
	Inverter Overload capacity	≤105 %: continuous, 106% ~ ≤125%: 10 minutes; 126% ~ ≤150%: 1 minute; >150%: 1 second
10	Display Panel (In-built LC Display & LED )	
	Measurements (On LCD)	Input: Voltage / Frequency, Bypass: Voltage / Frequency, Output: Voltage / frequency, Battery: Remaining time / Battery Level Indicator, Load: Percentage / Load Level Indicator, Battery Voltage Capacity/Status/Test Result, System Date/Time Setting, Current Time, PFC Fuse Open, Battery Temperature Too High, Battery Over Charge, Battery Out of Date, INV Short Circuit, Output Breaker Off, kVA, kW, output current, Battery current.
	Fault Indication (On LCD)	Main Input Sequence Fault, Battery Ground Fault, Bypass Static Switch Fault, Parallel Fault, System General Fault, Provide Bypass O/P Even If UPS Fault.
	Indications (LED)	Normal-Green/Battery-Orange/Bypass-Green/Fault-Red
11	Alarms	
	Audible Alarms	Battery Low beep / DC Fault beep/ UPS Overload beep/ o/p short ckt. fault beep/ Shutdown beep
12	Battery Backup / Battery Bank & Charger	
	Backup Required	30 Minutes
	Battery Bank Voltage	Vendor to indicate
	Battery Bank VAH	Suitable for 30 Minutes battery backup
	Batteries Type	Sealed Maintenance Free (SMF) - 12V Cells
	Battery Makes	Amara Raja / Exide / HBL / Hoppecke
	Number of Battery Banks	Maximum Two Banks in parallel

	Minimum Charger Rating (Including internal / external)	The charger should be able to deliver charging current equivalent to 10% of Battery Ah rating offered. (In case of external chargers, suitable monitoring of the chargers should be provided in the UPS. Also all external chargers taking AC input must have PFC - Power factor correction)
	Charger type / Charging Method & Charging Voltages	Constant Voltage Constant Current Solid state SMPS charger Float Charge 270V±(2V) Boost Charge 280V±(2%V)
	Battery recharge time (After complete discharge) to 90% capacity	10-12 hours
	Battery Housing (Vendor to provide the GA drawings of the offered Battery Rack)	Should be compact and space saving MS steel open racks complete with interconnectors
	Battery End Cell Voltage	1.85 V/cell
13	Interfaces	
	Serial Communication RS232 Port (Option of USB Port should be available)	RS232 Port should be provided as standard in the UPS. However, there should be provision for USB port also in the UPS.
	REPO (Remote Emergency Power OFF) / ROO (Remote ON - OFF) Port	Provide both onsite & remote EPO to shutdown UPS when emergency situation happens. REPO Port with a user-supplied switch

	Interface to BMS (Building Management System)	ModBus Card for connecting to UPS to BMS thru RS485 & monitoring thru BMS
	UPS status information presented as 3 contact closures	UPS should have configurable input signal as shutdown UPS or battery test dry contact.
14	Restart / Testing Capability	
	Cold Start	UPS should start up On AC Supply (Mains) without DC Supply (Batteries) On DC Supply (Batteries) without AC Supply (Mains)
	Automatic Restart	UPS should start up automatically on mains resumption after battery low shutdown
	Self-Diagnosis	UPS should be capable to carry out self-test of Rectifier / Charger /Battery & Inverter module during start-up
15	Physical	
	Operating Temperature	0°C ~ 40°C
	Storage Temperature	-20°C ~ 40°C
	Operating Humidity	< 95%
	Operating Altitude	0 to 3000m(0 To 10000ft)
	Type of Cooling	Forced Air
	Noise Level	< 60dBA at 1 Meter
	Air Filters	UPS should have internal anticorrosion air filters for dust filtration

	Dimension (w x d x h) in mm	To be furnished by the vendor
	Weight - in kg	To be furnished by the vendor
	Reliability	MTBF greater than 100000 hours
	Packaging Material / Vibration Withstand & Drop Test	Recyclable (No CFC) & 1. Vibration testing as per ISTA -1G Non-operational with Packing
	Standard Package of UPS to include the following minimum accessories	1.SMART Slot 2.MINI Slot 3.Parallel Port 4.RS232 Port 5.REPO Port 6.Charger Detection Port 7.Input Dry Contact 8.Output Dry Contact 9.USB Port
	Parallel Configuration	UPS should have capability for parallel 4 units.
	DC bus Capacitor	UPS DC bus capacitor have minimum life of 5 years@40°ambient.
16	Certifications	
	Manufacturer	QMS: As per ISO 9001: 2008 EMS: As per ISO 14001: 2004 OHSAS As per ISO 45001: 2018 LEED Certified Factory setup

Product Safety Certifications (Mandatory)	ESD:IEC61000-4-2: level4 RS : IEC61000-4-3: level3 EFT: IEC61000-4-4:level4 SURGE: IEC61000-4-5:level4 CS: IEC61000-4-6: level3 IEC 61000-2-2 EN 62040-2 EN 61000-3-2
ROHS & CE compliance	UPS should be ROHS compliance & CE Certified

**b. ILLUMINATION UPS**

Sr. No.	Specifications	Requirement
1	Type	1-Phase Input / 1-Phase Output Rack mountable UPS with 30 minutes backup.
2	Technology and Capability	<ul style="list-style-type: none"> <li>a) True Online configuration with double conversion UPS &amp; Zero transfer time.</li> <li>b) DSP based control with advanced technology.</li> <li>c) Wide Input voltage range from (80 ~ 280VAC)</li> <li>d) Auto restart &amp; capability with the Independent battery bank operation of the UPS.</li> <li>e) UPS should be designed at Rated PF of minimum 0.9.</li> <li>f) Generator compatibility with cold start and AC start features.</li> <li>g) Automatic bypass to transfer the load on mains due to overload &amp; internal fault.</li> <li>h) ECO mode should be available in the UPS.</li> </ul>
3	Model Name & Number	
	Make / Model / Part No to be specified by the vendor	
4	Input	
	Input facility - Phases / Wires	Single-Phase / 2-Wire & Gnd. (1Phase & Neutral + Ground)

	Input Voltage	240V, 1 Phase, 2 Wire, AC
	Nominal Input Frequency	50 Hz
	Input Frequency Range	40 to 70 Hz
	Input Power Factor	> 0.99(@ full resistive load)
	Generator Compatibility	Compatibility to genset supply required
	Input Protection	Should be provided at the input of the UPS suitable for the full rated capacity of the UPS.
5	Output	
	Nominal Output voltage	240V, 1 Phase, 2 Wire, AC
	Output Voltage Regulation	± 1% for linear load
	Nominal Output Frequency	50 Hz
	Output Frequency Regulation	± 0.1Hz
	Output Frequency Slew Rate	< 1Hz/sec
	Output Wave Form	Pure sine wave
	Output Voltage Distortion (THDu)	< 3% for linear load & < 5% for non-linear load.
	Crest Factor	3:1 On Full Load (Minimum)
	Output Short	Electronic Protection

	circuit Protection	
6	Transfer Time	
	Transfer Time (Mode of operation)	Zero ms from Mains mode to Battery Mode Zero ms from Battery Mode to Mains mode
	Transfer Time (Inverter to Bypass / Bypass to Inverter)	< 4ms
	Automatic Bypass switch	UPS should be capable of automatic change over to bypass.
7	Efficiency (At Nominal Voltage & Resistive Load up to kW rating of UPS)	
	Overall Efficiency (AC to AC) - Online (Double Conversion)	Upto 91% (at 100% load)
8	Overload	
	Inverter Overload capacity	<105% : continuous ; 105% ~ 125%: 1 minutes; 120% ~ 150%: 30 seconds; >150%: 0.5 seconds only
9	Display Panel (In-build LC Display & LED )	
	Measurements (On LCD)	Input Voltage & Frequency, Bypass, Output Voltage & frequency, Kilowatt, kVA, ECO mode, Battery & Load Level Indicator, Ambient temperature & Event code.
	Fault Indication (On LCD)	Charger warning, Fan fault, Temperature out of Range,+/-DC bus High/Low, Inverter Fault, DC-DC fault, abnormal output/Inverter voltage, output short circuit, charger fault, overload shutdown, battery low shutdown.
	Settable data	Inverter Voltage, Inverter Frequency, Standby bypass, ECO, Bypass Range, Buzzer, Battery Capacity, Battery

		String, & Overload alarm
	Indications (LED)	Green & Red
10	Alarms	
	Audible Alarms	Charger warning, Fan fault, Temperature out of Range,+/-DC bus High/Low, Inverter Fault, DC-DC fault, abnormal output/Inverter voltage, output short circuit, charger fault, overload shutdown, battery low shutdown.
11	Battery Backup / Battery Bank & Charger	
	Backup Required & required VAH	Suitable for 30 minutes backup time
	Battery Bank Voltage & VAH	24 V DC & VAH Suitable for 30 minutes backup time
	Batteries Type	Sealed Maintenance Free (SMF) - 12V Cells, VRLA
	Battery Makes	Amara Raja / Exide / HBL / Hoppecke
	Number of Battery Banks	Single Bank system.
	Minimum Charger Rating (Including internal / external)	The charger should be able to deliver charging current equivalent to 10% of Battery Ah rating offered. (In case of external chargers, suitable monitoring of the chargers should be provided in the UPS. Also all external chargers taking AC input must have PFC - Power factor correction)
	Charger type / Charging Method & Charging Voltages	Constant Voltage Constant Current Solid state SMPS charger
	Charger current	4A extended upto 8A with internal charger
	Battery Housing (Vendor to provide the GA drawings)	Should be compact and space saving MS steel open racks complete with interconnectors



	of the offered Battery Rack)	
	Battery End Cell Voltage	1.85 V/cell
12	Interfaces	
	USB Port should be available (Mandatory)	There should be provision for USB port also in the UPS.
	RS232 Port should be available (Mandatory)	There should be provision for RS232 port also in the UPS.
	Interface to Mini TVSS card	This card enable the UPS with the surge protection
	Interface to BMS (Building Management System)	ModBus Card for connecting to UPS to BMS thru RS485 & monitoring thru BMS
13	Restart / Testing Capability	
	Cold Start	UPS should start up On AC Supply (Mains) without DC Supply (Batteries) On DC Supply (Batteries) without AC Supply (Mains)
	Automatic Restart	UPS should start up automatically on mains resumption after battery low shutdown
	Self-Diagnosis	UPS should be capable to carry out self-test of Rectifier / Charger /Battery & Inverter module during start-up
14	Physical	
	Operating Temperature	0 to 40 deg C
	Storage	-15 to 50 deg C

	Temperature	
	Operating Humidity	5% ~ 95%RH (No Condensing)
	Operating Altitude	0-1000m
	Type of Cooling	Forced Air
	Noise Level	< 40 dBa at 1 meter distance
	Dimension (w x d x h) in mm	To be furnished by vendor
	Weight - in kg	To be furnished by vendor
	Packaging Material / Vibration Withstand & Drop Test	Recyclable (No CFC) & 1. Vibration testing as per ISTA -1G Non-operational with Packing
	Standard Package of UPS to include the following minimum accessories	1. UPS 2. Input cable 3. Battery cable 4. USB cable 5. User Manual
15	Certifications	
	Manufacturer	QMS: As per ISO 9001: 2015 EMS: As per ISO 14001: 2015 OSHAS: As per ISO 18001: 2007 EMS: As per ISO 14064-1:2012
	Product Safety Certifications (Mandatory)	BIS Certification
	Product Safety Certifications (Mandatory)	CE Certification

	Product Safety Certifications (Mandatory)	RoHS Certification
--	---	--------------------

### 13.14 CABLING

- a. Cables between UPS, battery and isolation transformer as well as between 3 phase input supply and UPS thru MCCB are included in the scope of work.
- b. All LT power cables shall be FRLS type with following specific requirements.
- c. Cu conductor, stranded, grade H4, class 2 as per IS 8130.
- d. Insulated with extruded XLPE compound.
- e. Provided with inner and outer sheath of extruded black PVC compound (Type ST-2).
- f. The control and annunciation cables will be 1100V grade, multicore, 2.5 sq.mm cross-section, annealed high conductivity stranded copper conductor, FRLS PVC insulated with inner and outer PVC sheath. The cables shall generally conform to IS: 1554-1988 with relevant parts thereof. All control cables shall be with following specific requirements:
  - Copper conductor stranded class 2.
  - Insulated with extruded PVC compound.
  - Provided with inner and outer sheath of extruded black PVC compound.
  - The construction, performance and testing of cables shall comply with IS: 7098 and IS: 1554-1988.
  - Uninyvin cables shall be used for connection between battery & UPS system.
  - All cables shall be terminated at both ends. Double compression glands with tinned copper lugs shall be used in indoor and outdoor application.

### 13.15 PERFORMANCE TESTS ON UPS

- a. Type and routine tests certificates for all components made use in the UPS system shall be furnished. Tests for components shall be as per relevant standard indicated.
- b. Contractor shall furnish his quality assurance plan for the equipment offered. The quality assurance plan shall include bought out components and assemblies used in the UPS system.
- c. Routine tests on the complete UPS system shall be carried out as per relevant standards for each major sub-system in the UPS, viz., Rectifier, Inverters, batteries, stand-by supply etc.

- d. System tests shall be performed on the completely assembled UPS system. System tests shall include frequency regulations. Voltage regulation, current limiting feature and harmonic content tests in addition to the tests to prove the functional requirements such synchronisation with range of adjustments, transfer of static switches for conditions of loss of square wave, overload and under voltage conditions.
- e. Type, routine and optional tests covered under clause 7.3 of IEC-60146-4 shall be conducted on the UPS system in addition to the system tests.
- f. Endurance test on static switches shall be performed for not less than 10 transfer / retransfer cycles at full load.
- g. Heat run test shall be carried out on each branch of UPS including bypass (if provided) and on overall UPS system at rated load under relevant ambient conditions for a period of 8 hours. This test shall be conducted as a routine test on all UPS being supplied.

#### **13.16 TRAINING OF PERSONNEL**

- a. Training of GSCL's personnel shall be free of cost to enable them to operate, troubleshoot and maintain the offered equipment/ components. The general guidelines for the training requirement, description of type of training required and the duration of training shall be indicated by the Bidder to fulfil the above objective.

#### **13.17 FACTORY ACCEPTANCE TESTS**

- a. Contractor shall also include cost towards factory testing in presence of CONSULTANT/ GSCL's - 3 persons.
- b. The Contractor shall inform the CONSULTANT/ Engineer well in advance before delivering the equipment at site. It shall be discretion of GSCL to waive off the inspection of equipment.

#### **13.18 STORAGE AT SITE**

- a. Contractor shall indicate the specific requirements, if any for proper storage of the equipment supplied at site.
- b. In general, while shipping the equipment to site, Vendor shall ensure that each assembly or component shall be crated, boxed or otherwise suitably protected against damage or loss during shipment and to facilitate site storage. All openings shall be effectively sealed with temporary closures to prevent entry of dust, dirt, moisture and other foreign matter.

### **13.19 DOCUMENTATION (UPS)**

- a. Both hard and soft copies (Auto- Cad) of all drawings shall be furnished right from approval stage.
- b. The Contractor shall plan his manufacturing schedule so as to allow at least two weeks' time for approval of the drawings after their receipt by the GSCL.
- c. Upon completion of the installation, the Contractor shall furnish a complete set of soft copies drawings (Auto- Cad version) in CDs and hard copies.
- d. Drawings prepared by the Contractor and approved by the GSCL shall be considered as a part of the Contract Specification. However, examination and approval of the drawings by the GSCL shall not relieve the Contractor of his responsibility for engineering, design, workmanship, materials and construction under the Contract.
- e. If, at any time before the completion of the work, changes are made necessitating revision of approved drawings, the Contractor shall make such revisions and proceed in the same routine as for the original approval.
- f. The GSCL shall reserve the right to comment on drawings and documents under information category and inform the Contractor to treat these drawings and documents as approval category.

## **14 BATTERY**

### **14.1 SCOPE**

- a. This specification covers requirements of sealed VRLA lead acid battery complete with battery racks, inter-cell and inter-tier connectors and all other accessories.

### **14.2 CODES & STANDARDS**

- a. The design, manufacture and performance of equipment shall conform to the latest applicable electrical rules, all currently applicable standards codes of practice, regulations and safety codes of the locality where the equipment are to be installed. In case of conflict between these standards and specification, requirements of this specification shall govern. Nothing in this specification shall be construed to relieve the Contractor of his responsibility.
- b. All codes and standards referred to in the specification shall be understood to be the latest version on the date of offer made by the bidder unless otherwise indicated.
- c. The Contractor shall ensure that instruments and gauges to be used for testing and inspection of critical parameters as identified in the specification have valid calibration and the accuracy can be traced to National standards.

### **14.3 FEATURES OF CONSTRUCTION**

- a. The equipment offered shall be complete with all parts that are necessary or usual for the efficient operation of the equipment, whether specifically mentioned or not.

### **14.4 SEALED LEAD ACID BATTERY**

- a. The sealed batteries shall be starved electrolyte type ( with electrolyte immobilised in a micro porous material ) to allow recombining of generated oxygen internally. The battery shall be completely explosion resistant, shall tolerate freezing and shall not allow gases to escape during normal charging conditions. The battery shall not require any topping and be maintenance free. The batteries shall conform to IEC: 60896-2 or equivalent standard.

### **14.5 CONNECTORS AND TERMINAL POSTS**

- a. Inter-cell and inter-tier connectors and terminal posts shall be of low resistance corrosion resistant alloy/copper. Terminal posts shall be designed to accommodate external bolted connection conveniently and positively. Each terminal post shall have two bolt holes of the same diameter, preferably at right

angles to each other. The bottom hole shall be used to terminate the inter-cell connection. The top hole shall be left for PURCHASER'S terminal connection. All the metal parts of the terminals shall be lead coated if necessary. The VENDOR shall indicate this in the bid. The junction between terminal posts and cover and between cover, and container shall be so sealed as to prevent any seepage of electrolyte. All terminals shall be provided with FRLS insulated covers/shrouds.

- b. All inter row, inter cell and inter row connectors shall be covered with heat shrunk FRLS sleeves.
- c. The shrouds for Battery terminal shall be of FRLS (anti-static type).

**14.6 CONTAINERS**

- a. Containers, cell lids, safety vents, acid level indicators, separators, connectors, electrolyte, shall conform to the relevant IS/IEC standards. The cell containers and vent plugs, in addition, shall conform to the safety requirements of UL 924 or equivalent safety standard. The safety vent shall be self-Resealing pressure regulating with flame arrestor. In case the batteries are proposed to be housed in a sheet metal or polymeric enclosure, the same is deemed to be included in the scope of the bidder. The enclosure for battery shall conform to the safety provisions of UL 1778 or equivalent standard.
- b. Container should have adequate Mechanical strength to prevent bulging, cracking etc. during the life span of battery when operating under expected temperature range and due to action of static and dynamic loads and the action of electrolyte.
- c. Containers shall be transparent and of Flame-retardant material.

**14.7 THERMAL RUNAWAY**

- a. In order to prevent thermal runaway an air flow distance of 10 mm shall be provided between the cells.

**14.8 ACCESSORIES**

- a. The battery shall be complete with accessories and devices, including but not limited to the following:
  - Battery racks
  - Cell and stand insulators.
  - Set of intercell, inter-tier and interbank connectors as required for the complete installation.
- b. Accessories for testing and maintenance.

a)	One	±3 volts DC voltmeter with built in discharge resistor and suitable leads for measuring cell voltage.
----	-----	---

b)	Three	Pocket thermometers
c)	Two	PVC aprons
d)	Four	PVC gloves Any other protective wearing apparatus if required, to be specified by VENDOR
e)	Two	Cell lifting straps
f)	One set	Terminals and cable boxes with glands for connecting cable as required. Spare connectors Spare vent plugs Spare nuts and bolts Suitable set of spanners PVC spill trays under the battery cells.
g)	One	Insulated wrencher

#### **14.9 BATTERY LAYOUT**

- a. The Contractor shall review the battery room dimensions/ Layout drawings included with the tender specifications and suggest suitable battery layout, providing dimensioned drawings.
- b. An air flow distance of 10 mm shall be provided between the cells to allow better heat dissipation and minimise chances of thermal runaway.
- c. No of battery banks shall be as specified under UPS section above.

#### **14.10 BATTERY RACKS**

- a. Battery racks shall be constructed from good quality teak wood and painted with two coats of polyurethane which acts as a strong resistant to sulphuric acid and fitted with cell number plates . Metallic stands MS Rack designed to withstand the seismic forces shall be provided suitable for the seismic zone. Metallic stands shall be painted with acid resistant paint after 2 coats of primer. The construction of the racks shall be suitable for fixing to a flat concrete floor. The racks shall be rigid, mechanically strong, free standing type and free from



wrap and twist. The completed racks shall be suitable for being bolted end to end to form a continuous row. Insulators shall be provided below the legs of the stands.

- b. The racks shall be of single tier/ two tier construction depending on the final layout based on space availability. The number of tiers shall be subject to GSCL's approval.

#### **14.11 VENTILATION**

- a. Proper ventilation in the battery room shall be done by Bidder.

#### **14.12 BATTERY SIZING**

- a. The no. of cells in the battery shall be offered by Contractor. The Contractor shall guarantee the performance of the battery for the duty requirements indicated over the entire range of temperature and also at the minimum ambient temperature specified with the derating factors and ageing factor and temperature correction factors. The procedure for sizing the battery shall be as detailed in IEEE 485. Design margin to be considered has been specified in Design Criteria above.
- b. The DC system voltage at DC bus shall be specified by the Contractor.
- c. The Normal cell voltage shall be 2.0 V per cell
- d. The Max Float charge voltage shall be 2.25V per cell
- e. The Boost charge voltage shall be 2.75V per cell
- f. The End cell voltage shall be 1.85 V per cell
- g. The Total Momentary Load/Duration/Voltage at the end of this duration – To be defined by Contractor.
- h. For selecting the number of cells, bidder shall consider a voltage drop of 3 % between the battery and the UPS.
- i. Contractor shall demonstrate the performance of the battery at the specified duty cycle, at the specified min. ambient temperature during pre-dispatch inspection, by conducting test on a randomly selected cell.

#### **Temperature Range**

Min. Temp.	5 Deg. C
Max. Temp.	50 Deg. C
Ave. Temp.	32 Deg. C

### **14.13 CHARGING**

- a. The proposed method of charging the battery shall be Float cum Boost.
- b. Contractor shall state whether an equalising charge is recommended for the battery. If so, the equalising charging voltage, current, duration and the interval between the equalising charging shall be specified in the BID. Contractor shall also indicate the requirements for boost charging.
- c. The charger shall be constant voltage, current limiting type unless otherwise stated.

### **14.14 LIFE**

- a. Contractor shall quote in his offer the guaranteed life of the battery when operating under the conditions specified.

### **14.15 TESTS**

- a. All tests shall be conducted as per the relevant standards. Tests shall include routine & acceptance tests.
  - Routine Tests shall comprise of the following:
    - i. Visual inspection
    - ii. Dimensional check
    - iii. Capacity
    - iv. Retention of charge test
    - v. Ampere-hour and watt-hour efficiency test.
    - vi. Endurance test
    - vii. Short circuit current and internal resistance measurement test.
  - Test for suitability of floating battery operation.
    - i. In application where the first momentary discharge is high and, lasts for several minutes a high discharge test shall be conducted, in addition to the above tests.
    - ii. Type test report on an identical type and capacity of the battery shall be submitted for GSCL's review. If type tests reports are not available, then these Type tests shall be conducted on a minimum of one sample cell typical and identical with the cells forming the complete battery offered. However, the test cell shall not be one of the cells offered in the battery offered.
  - ACCEPTANCE TESTS-Acceptance tests shall be conducted at site on completion of installation and commissioning and immediately prior to putting the battery in service. These tests shall comprise of:
    - i. Visual inspection
    - ii. Dimensional check

- iii. Capacity test
  - iv. Test for voltage during discharge
  - v. Storage test
  - vi. Insulation resistance
  - vii. Vendor shall carry out the capacity test for the following conditions:-
  - viii. For the load cycle
  - ix. For 10 Hr discharge as per IS-1651
- The battery voltage at the end of the cycle time shall not be less than the values specified.
  - The vendor shall ensure that instruments and gauges to be used for testing and inspection of critical parameters as identified in the specification have valid calibration and the accuracy can be traced to National/International standards.

#### **14.16 TEST REPORTS**

- a. A copy of routine and type test results shall be submitted for approval before the dispatch of batteries. Specified number of bound copies of complete test results shall be furnished with the batteries.

#### **14.17 SPARE PARTS**

- a. Contractor shall include the following items in his recommended list of spares:
  - Inter-cell/ Inter-row/Inter-bank/connectors
  - Battery stand insulators and cell insulators
  - Nuts, bolts, washers, etc.
  - Vent plugs/Vent plugs cum level indicators

#### **14.18 IDENTIFICATION**

- a. Each cell shall be marked in a permanent manner in accordance with relevant standard. In addition, each cell shall be legibly numbered serially to identify the cell during manufacture, testing, installation and operation of battery to identify after having assembled into battery bank in battery racks. A set of loose stickers shall be provided to mark the cells position in the assembled battery bank.
- b. Each cell shall be marked as per IS-1651 and IEC-486-1. Additionally, the polarity of the cells shall also be marked.

#### **14.19 TRANSPORT**

- a. The sealed lead acid battery shall be transported with the electrolyte immobilised, sealed & fully charged.

## **15 DOCUMENTS REQUIRED TO BE SUBMITTED BY BIDDER DURING TECHNICAL BID**

- a. Power distribution philosophy with all the proposed equipments and accessories along with its ratings and Key Single Line Diagram (with equipment & bus rating and fault level at each bus) upto Distribution Board level.
- b. Operational philosophy of the system, Technical Features of Major critical equipments like CSS, DG, Luminaires, UPS, batteries, EV Chargers etc.
- c. No deviation certificate shall be submitted by Bidder in the prescribed format stating that they will comply with all the terms and conditions of the specifications as well as all the latest relevant statutory regulations and standards as applicable.
- d. Execution approach methodology for Power Distribution System for the project.

## **16 DOCUMENTS REQUIRED TO BE SUBMITTED BY CONTRACTOR AFTER AWARDING OF THE BID**

### **16.1 The Following minimum Drawings shall be submitted by the Contractor to GSCL for the approval**

- a. Detail Single Line Diagram ( with equipment rating, bus rating, fault level, CT/PT rating, alarm & annunciation etc.) for Power Distribution of the ICCB Building
- b. Calculations
  - Electrical Load List and demand Calculations
  - HV & LV Panel sizing with switchgear rating calculations
  - UPS Sizing Calculations
  - Earthing Calculations for Electrical System
  - Lightning Protection Calculations
  - Cable schedule with Sizing Calculations
  - Lighting Calculations for each Area ( Dialux Files shall be provided along with PDF)
  - Fault level calculation.
  - DG sizing calculation.
  - Capacitor Sizing Calculation

- c. Type and routine test report shall be submitted for the Owner's approval before the equipment is dispatched. Bound copies of test reports shall be furnished.
- d. Inspection by Owner/ Engineer will not be carried out unless the Vendor confirms that calibrated equipment is ready for proceeding with the tests.
- e. Equipment shall not be procured unless the manufacturing clearance shall be provided by Owner.
- f. Vendor shall carry out all routine tests as specified in relevant IS/ IEC standards on all major components and furnish copies of test reports for Owner's approval. Wherever required, Vendor shall conduct the necessary type tests in the presence of Owner's representative based on the unit prices available in the bid.
- g. Vendor shall also carry out all routine and functional tests as specified in the relevant IS/IEC in the presence of the Owner's representative at works before despatch and furnish copies of test reports for approval. If required stage inspection, will be carried out by the Owner.
- h. Vendor shall furnish copies of routine test report for all bought out items for Owner's approval.

- i. Detail Vendor Equipment Drawing for following items shall be submitted by Bidder for approval:

- **CSS**

- i. Overall GA indicating equipment arrangement, dimensions & section
- ii. Single Line iagram
- iii. Data Sheet of major equipment
- iv. Mounting Arrangement
- v. Foundation Details with calculations – GA; Civil Construction drawings
- vi. Trench Details
- vii. Earthing Layout
- viii. Fence details
- ix. Bill of Materials
- x. General arrangement drawing of the transformer, showing plan, front elevation and side elevation complete with all accessories and fittings, detailed dimensions, net weights, crane lift for untanking, size of lifting lugs and eyes, clearances between HV terminals, between LV terminals, between HV and LV terminals, between HV & LV terminals and ground etc.

- xi. Rating, diagram and terminal marking plates, complete with polarity and vector group.
- xii. General arrangement of HV cable box with air insulated disconnecting chamber.
- xiii. General arrangement of LV Cable Box.
- xiv. General arrangement of marshalling box & wiring diagram.
- xv. General arrangement of OCTC & wiring diagram.
- xvi. GTP for Transformer.
- xvii. Documentary evidence for the purchase of CRGO sheet, Winding Copper Wire etc.
- xviii. Type test Certificates
  - IP Protection
  - Impact Withstand capacity
  - Heat Run test
- xix. Power & Control Wiring Diagram

- **DG**

- i. Overall GA
- ii. Single Line Diagram
- iii. Data sheet of major Equipments
- iv. Type test Certificates
  - a) IP Protection
  - b) Impact Withstand capacity
  - c) Heat Run test
  - d) Mounting Arrangement
- v. Foundation Details with calculations – GA; Civil Construction drawings
- vi. Trench Details
- vii. Piping layout – Diesel, Exhaust
- viii. Chimney Structural Drawings with Foundation and Calculations
- ix. Earthing Layout
- x. Fence details if provided
- xi. Bill of Materials
- xii. Makes of Components offered
- xiii. Engine Drawings and Test Certificates
- xiv. Alternator Drawings and Test Certificates
- xv. AMF Panel
  - a) GA Drawing
  - b) Wiring Diagram
  - c) Type test Certificate for Short Circuit withstand capacity
  - d) Type test certificate for IP protection

- **LV Panels – Floor Mounted and Wall Mounted**

- i. GA Drawing
- ii. Door open view of Wall mounted Distribution boards
- iii. Data sheet of major Equipments
- iv. Wiring Diagram
- v. Type test Certificate for Short Circuit withstand capacity
- vi. Type test certificate for IP protection
- vii. Bill of Quantities

- viii. Makes Of Components offered
- ix. Bus bar sizing calculations
- x. Foundation drawings
- xi. Type test reports for the switchgear panel of similar rating for the following tests shall be submitted along with the Bid (not older than 5 years):
  - Temperature rise
    - a) Degree of protection
    - b) Internal arc with make of components being offered
    - c) Short circuit
- xii. The switchgear, circuit breakers and all associated equipment shall be tested in accordance with relevant standards. All routine tests shall be carried out. Type tests shall also be carried out if not tested previously.

- **UPS**

- i. GA Drawing
- ii. Single line diagram
- iii. Wiring Diagram
- iv. Data Sheet
- v. Battery Details – GA, Rack GA, Connection details
- vi. Type Test Certificates – Heat run test, IP protection
- vii. UPS Room Space Planning.
- viii. Battery sizing calculations.
- ix. Product catalogue
- x. General arrangement of UPS & isolation transformer
- xi. Battery catalogue & Battery sizing calculations.
- xii. Bill of material



**16.2 Construction Drawings of the following**

- a. General arrangement of equipment Layout of the Electrical rooms/ Ducts/ UPS Rooms on each Floor
- b. Lighting Layout for each floor & room
- c. Receptacle Layout for each floor
- d. Switch Board Schedule
- e. Point Wiring Drawing for Lighting and power
- f. Cable tray Layout for each floor
- g. Raceway Layout for each floor
- h. Earthing & Lightning Protection
- i. Outdoor lighting layout
- j. Cutouts drawings with dimension
- k. Steel Support drawings etc.

**16.3 The Contractor shall plan his manufacturing schedule so as to allow at least two weeks time for approval of the drawings after their receipt by the GSCL.**

**16.4 Upon completion of the installation, the Contractor shall furnish the following;**

- a. Three (3) Complete set of construction As Built drawings
- b. Soft copies of the construction As Built drawings in CDs.
- c. Four (4) Sets of All Instruction and Operation & Maintenance Manuals for each equipment
- d. Two (2) Sets of Test Certificates of equipments provided by the Contractor along with that of the respective Components outsourced.

**16.5 The GSCL shall reserve the right to comment on drawings and documents under information category and inform the Contractor to treat these drawings and documents as approval category.**

## **17 PRE COMMISSIONING TESTS ON ELECTRICAL SYSTEM EQUIPMENT TO BE CARRIED OUT AFTER INSTALLATION:**

**17.1 PRE-COMMISSION TESTS:** Pre-commissioning tests in addition to mentioned in the specification requirements for various equipments but not limited to following shall be carried out by Contractor in presence of Purchaser/ Purchaser's representative. Commissioning shall be carried out only after obtaining satisfactory results, acceptable to Purchaser/ Purchaser's representative.

### **17.2 Distribution Transformer**

- (a) Insulation resistance test HV side, LV side and HV - LV.
- (b) Magnetizing current test.
- (c) Winding resistance test.
- (d) Voltage Ratio & Tap continuity test at all tap.
- (e) Vector group test.
- (f) Magnetic Balance Test.
- (g) Buchholz Relay Test (if any)
- (h) Neutral CT Test (if any)
- (i) Winding Temperature Indicator / Oil Temperature Indicator Test
- (j) Polarization Index Test (For LV windings 3.3 KV and above)
- (k) Local / Remote operations of OLTC (if any)
- (l) Operational tests of RTCC panel (if any) as per schematic drawing.
- (m) No load test and performance observations

### **17.3 HT Switchgear**

- (a) IR values of power and control circuits
- (b) Local/ Remote operations in test as well as service position including all electrical interlocks
- (c) Control circuit and operational tests as per schematic drawing.
- (d) Tripping through relays and trip circuit health.
- (e) Anti pumping device operation
- (f) Protection system operation stability and sensitivity by primary injection testing method including testing of metering circuits
- (g) HV Test on switchboard
- (h) Panel indication, annunciation, space heater circuits

- (i) Spare contact for customer use
- (j) Termination correctness & proper installation.

#### **17.4 LT Metal Enclosed Switchgears:**

- (a) IR Values of power & control circuits.
- (b) Mechanical charging - closing - tripping of breaker.
- (c) Electrical charging - closing - tripping of breaker.
- (d) Trip circuit healthiness and tripping through relays.
- (e) Remote closing / Tripping / Interlocks circuits
- (f) Indication / Annunciation / Panel space heater circuit / Spare contacts for customer use
- (g) Secondary injection testing of protective relays/ releases.
- (h) CT testing for polarity, ratio, IR values and magnetization for class PS characteristics
- (i) PT testing for ratio, IR values.
- (j) IR Values of breaker.
- (k) Testing of modules for DOL/ Star-Delta/ Soft Starter starting or any other starting method as per the schematic drawings applicable.

#### **17.5 Power and Control Cables:**

- (a) IR Values before Hipot
- (b) Hipot Test - Measurement of leakage current
- (c) IR Values after Hipot

#### **17.6 Induction Motors:**

- (a) IR Values
- (b) Polarization Index Test
- (c) Interlocks and simulation tests local / remote operations
- (d) No load test

#### **17.7 Control Panels for Miscellaneous Equipment:**

- (a) IR Values of all power circuits
- (b) Operational test and scheme - wiring testing as per control schematics

#### **17.8 Lighting System:**

- (a) Visual inspection for operating problems
- (b) System activation -burning in the lamps for 100 Hrs
- (c) Measuring light level & reflectance.

**17.9 Earthing System:**

- (a) Earthing resistance of each electrode.
- (b) Earthing resistance of grid.

**HVAC WORKS – TECHNICAL SPECIFICATION**

## **AIR-CONDITIONING & VENTILATION SYSTEM - TECHNICAL SPECIFICATION**

### **1.0 DESIGN BASIS**

#### **1.1 DESIGN AMBIENT CONDITIONS:**

Design ambient condition for cooling load estimation shall be considered as indicated below:

<b>Season</b>	<b>Dry Bulb Temperature (DBT) (°C)</b>	<b>Wet Bulb Temperature (WBT) (°C)</b>
Summer	33.6	26.5
Monsoon	27.8	26.5
Winter	11.1	8.3

#### **1.2 HANDLING FACILITY**

All the equipment will be provided with suitable lugs & lifting tackles for ease of handling for erection and maintenance purpose. The components of the equipment will be so designed to enable them to be handled easily with the conventional handling facilities.

#### **1.3 ANCHOR, BOLTS, INSERTS ETC.**

Anchor, bolts, inserts etc., as required, for installation of the equipment, duct, pipe and accessories will be provided by the HVAC contractor.

#### **1.4 SYSTEM BALANCING**

- a) System balancing is a process for maintaining the performance of an HVAC system and for providing the occupants with a comfortable conditioned space. Construction documents shall require that all HVAC systems to be balanced in accordance with generally accepted engineering standards. Construction documents with written balance report to be provided to the Purchaser for HVAC systems.

b) Construction documents with following information to be provided to properly operate & maintain the system that has been properly balanced.

- HVAC equipment capacity
- Equipment operation & maintenance manuals
- HVAC system control maintenance & calibration information including wiring diagram, schedules & control sequence descriptions
- Complete written narrative of how each system is intended to operate

#### 1.5 OTHER SERVICES TO BE PROVIDED BY HVAC CONTRACTOR

- Making minor wall /slab openings for passage of duct /pipes & making good of the same.
- Sealing of the balance opening by rock wool and fire-retardant seal after duct /pipe erection.
- Scaffolding as required.
- Weather proofing and painting of structural supports of outdoor units as directed by engineer/consultant.

#### 1.6 DURATION OF OPERATION

The Air conditioning & Ventilation System shall be designed considering continuous operation. However, depending upon the actual requirement, duration of operation of HVAC equipment shall be finalised.

#### 1.7 NOISE AND VIBRATION

- a) The design of all equipment and accessories shall ensure of noise and vibration levels within the limits as per latest codes and standards. Noise level inside equipment plant room shall be limited to 85 dB (A) at a distance of 1.5 m and noise level at supply air grilles inside air-conditioned space shall be restricted to 65 dB (A) when measured at a distance of 1.5 m.
- b) The overall vibration level shall be as per zones A and B of ISO 10816-1.

## 1.8 CODES AND STANDARDS

Equipment covered in this section shall comply with latest edition of the appropriate equivalent international standards, all currently applicable statutes, regulations and safety codes in the locality where the equipment shall be installed with particular reference to those set out below:

<b>Sl. No.</b>	<b>Standard</b>	<b>Description</b>
1.	NBC : 2016	National Building Code – Air- Conditioning & Fire Protection
2.	ASHRAE standard 90.1-2016	Energy standard for buildings except low rise residential buildings.
3.	ASHRAE 55	Thermal comfort
4.	AHRI -1230 Standard	Performance Rating of Variable Refrigerant Flow Units.
5.	ASHRAE Handbooks	American Society for Heating, Refrigerating and Air- Conditioning Engineers.
6.	IS: 655/SMACNA	Duct construction standards
7.	ASHRAE 52.2-2012	Air Filters
8.	IS 277	GI Sheet
9.	ASHRAE Standard 62.1-2016.	Ventilation for Acceptable Indoor Air quality
10.	ECBC 2016	Energy Conservation Building Code
11.	ISHRAE	HVAC Handbook - Air conditioning & Ventilation
12.	IS: 661	Thermal Insulation for Cold Surfaces
13.	IS 2312	Propeller type ventilation fans
14.	IS 3588	Electric axial fans
15.	IS 4894	Centrifugal fans
16.	UL 555	Fire dampers
17.	IS 12065	Permissible limits of noise level for rotating electrical machines



18.	IS 12075	Mechanical vibration of rotating electrical machines
-----	----------	--

## 2.0 DESIGN PHILOSOPHY

### 2.1 AIR-CONDITIONING SYSTEM

Network Room & Data Centre shall be air-conditioned with Precision Type Air-conditioners (100% Standby). For other areas, Variable Refrigerant Flow (VRF) type air-conditioning system shall be considered to meet the air-conditioning requirements. Outdoor units shall be located at the Terrace of the building. The capacity of Air-conditioning equipment shall be designed as per the Design Philosophy elaborated herewith. Sizing calculations for all the equipment shall be submitted by the Contractor for approval of Consultant / Purchaser. For details of Air-conditioning equipment to be considered for each area, refer relevant table of the Technical specification.

- a) Inside design condition to be considered for cooling load estimation for different areas are as below:

Areas	Inside condition
Network Room / Data Centre	21 ± 1 °C, RH 50 ± 5%
Balance human occupied areas like CCC / Cabins / Workstations / Canteen / Reception Area / Conference Room / Entry Lobby etc.	24 ± 1 °C, RH upto 70%

- a) Air-cooled floor mounted Precision type air-conditioning units (1 Working + 1 Standby) shall be considered for Network Room & Data Centre. Respective IDUs shall be housed inside the PAC Room provided in the respective floor.
- b) Conditioned air for Network Room & Data Centre shall be distributed through insulated supply air duct along with diffusers / grilles. Return air shall be taken back to the respective PAC room from the area above false ceiling / below false floor area, as per layout requirements. Electrical strip heaters & Pan Humidifiers with controls (for areas with controlled RH) shall be considered.

- c) For other areas, VRF type AC units shall be used. CCC shall be provided with ceiling suspended ductable indoor units & ceiling suspended cassette type indoor units shall be considered for other areas of each floor, as per requirement.
- d) Outdoor units (ODU) shall be located at the terrace area of the building. Interconnecting insulated refrigerant pipework from respective ODU to individual indoor units (IDU) shall be routed through vertical shaft, provided inside the building.
- e) Brief design parameters of VRF units shall be as under:

Maximum Ambient Temperature	47 °C
Refrigerant	R410A / R407C / Eco friendly
Compressor Type	All inverter Hermetic/Semi-hermetic Scroll
Min. COP	As per ASHRAE 90.1 latest Standard

- f) The indoor air quality of air-conditioned areas served by the air conditioning units, shall be as per ASHRAE Standard – 62.
- g) Lighting load for AC System shall be considered as 10 watt/sq.M (or actual) for all the areas.
- h) Occupancy shall be considered as per actual / ASHRAE standard.
- i) Fresh air quantity shall be considered as per ASHRAE 62.1-2007. Fresh air shall be drawn by means of intake air louvers through pre- filters.
- j) Solar and transmission load through walls, roofs, doors, windows, glazing, floors etc. shall be considered.
- k) Fusible link type fire dampers having fire rating of 90 minutes shall be provided wherever duct crosses any wall/roof.
- l) Supply air ducting shall be designed based on equal friction method to have an velocity not exceeding 8 m/s. Return air ducting, if necessary, shall also be designed based on equal friction method to have an velocity not exceeding 6 m/s.
- m) External surfaces of all metallic parts (equipment, piping & valves, supports etc.) shall be painted with three coats of synthetic enamel paint over a coat of suitable primer.

- n) Each air-conditioning equipment shall be interlocked with fire detection systems, so that in case of fire respective fans can be automatically tripped upon receipt signal from FDA Panel.

## 2.2 VENTILATION SYSTEM

Ventilation system shall be designed as per the Design Philosophy & Equipment specification elaborated herewith. Sizing calculations for all the equipment shall be submitted for approval of Purchaser / Client. For details of Ventilation equipment to be considered for each area, refer relevant table of the Technical specification.

- a) Ventilation systems shall be designed based on required air change per hour (ACPH) OR heat load basis to maintain 5°C over & above ambient temperature, whichever is higher. However, Toilets, Pantries, Stores shall be ventilated on the basis of air change only.

- b) AIR CHANGES PER HOUR (ACPH):

Minimum ACPH of the ventilated areas shall be considered as indicated below.

SI. No.	Area	ACPH
1.	Toilets	10
2.	Electrical Room / Services Room / Pump Room etc.	15

- c) All ventilation systems shall operate on 100% fresh air.
- d) Fan outlet velocity & speed shall be as indicated below:

Maximum fan outlet velocity for fan upto 450 mm dia, m/sec	9.0
Maximum fan outlet velocity for fan above 450 mm dia, m/sec	11.5
Maximum fan speed for fans upto 450 mm dia, rpm	1440
Maximum fan speed for fans above 450 mm dia, rpm	1000

- e) Drive motors for all ventilation fans shall be rated at least 15 % higher than the power requirement at duty point or 10 % higher than the maximum power requirement at selected speed, whichever is higher. Starting torque requirements of fans shall also be considered to finalize the motor ratings.
- f) Ventilated Areas
- Electrical Rooms, Pump Rooms, Services Rooms etc. shall be ventilated through tube axial exhaust air fans & intake through louvers.
  - Toilets shall be ventilated through propeller type exhaust air fans & intake air grills shall be provided in respective doors.
- g) Exhaust air fan shall consist of fan with motor, rain protection cowl, bird screen etc.
- h) Each ventilation fan shall be interlocked with fire detection systems, so that in case of fire respective fans can be automatically tripped through FDA Panel. All equipment shall be interfaced with fire detection and alarm system.

### 2.3 AIR DISTRUBUTION SYSTEM

- a) Galvanized steel ductwork shall conform to IS:655 / SMACNA of various thicknesses ranging from 24 Gauge (0.63 mm) to 18 (1.2 mm) gauge according to duct sizes & shall have minimum zinc deposition of 180 gm/sq.m or better as per IS:277.
- b) Ductwork shall be designed based on equal friction method to have an velocity as mentioned below:

Max. allowable air flow velocity in supply air ducts for Air conditioning, m/sec	8
Max. allowable air flow velocity in return air ducts for Air conditioning, if any, m/sec	6
Max. air flow velocity in ducts for Ventilation, m/sec	10
Max. Friction, inch wg. / 100 ft duct length	0.1

Max. Outlet velocity at Grille/ Diffusers, m/sec- other area	2.5
--	-----

c) Air intake grilles / louvers shall have design face velocity of 2 - 2.5 m/sec.

### 3.0 TECHNICAL DETAILS

#### 3.1 AIR-CONDITIONING SYSTEM

##### 3.1.1 AREAS TO BE AIR CONDITIONED & TYPE OF UNITS

Air-conditioning shall be considered for the various areas as indicated below along with details of AC indoor (IDU) & outdoor units (ODU).

Sl. No.	Location	Dehumidified Air Quantity Each (CMH)	Capacity Each (TR)	IDU Quantity (Nos.)	Type of AC & IDU	Total ODU Capacity (HP)
<b>1.0</b>	<b>First Floor</b>					
	BMS Room, Record Room, Meeting Room, PA Room	0.6 TR x 4 Nos.			VRF Type - Ceiling Suspended 4-way Cassette Units for each room	16
	Conference Room, Manager Room	0.8 TR x 2 Nos.			-Do-	
	Receptions & Waiting, Workstations, Director Room	2 TR x 5 Nos.			-Do-	
<b>2.0</b>	<b>Second Floor</b>					
	Canteen	2 TR x 2 Nos.			-Do-	20 *
	UPS/Elec Room	2 TR x 3 Nos.			-Do-	
	Conference Room, Lobby Area	2 TR x 2 Nos.			-Do-	
<b>3.0</b>	<b>Third Floor</b>					
	Network Room & Data Centre	7,600	11	2 (1W+1S)	Precision Type - Bottom / Top discharge IDU	11 TR
	Lobby Area	2 TR x 1 No.			VRF Type - Ceiling Suspended 4-way Cassette Units	* Common ODU

Sl. No.	Location	Dehumidified Air Quantity Each (CMH)	Capacity Each (TR)	IDU Quantity (Nos.)	Type of AC & IDU	Total ODU Capacity (HP)
4.0	Fourth Floor					
	Conference Room	2 TR x 2 Nos.			-Do-	24
	CCC	5,250	8	2	VRF Type -Ceiling Suspended Ductable Split Units	

**Notes:**

1. Capacity of Air-conditioning equipment mentioned above are indicative & for reference only. Exact capacity & quantity of each item shall be finalised based on detail heat load calculations during engineering stage, to be submitted by the Contractor, as per latest architectural drawings and equipment heat loads of respective area.
2. Diversity factor of 10% have been considered while selecting ODU capacity. Bidder to consider suitable diversity factor during selection of ODU capacity in view of usage pattern.
3. Exact location of respective ODU shall be finalised during engineering stage, based on latest architectural drawings & fulfilling architectural requirements.
4. Any additional area requiring air-conditioning as per latest architectural drawings during engineering stage, shall be considered without any price implications.

3.1.2 EQUIPMENT SPECIFICATION

Details of AC equipment shall be as indicated below:

3.1.3 VRF UNITS

Variable Refrigerant Flow (VRF) type system has been proposed to meet the air-conditioning requirements. The indoor and outdoor units shall be inter-connected by insulated refrigerant copper piping and electrical cabling.

- a) The Air cooled full inverter VRF outdoor units shall be factory assembled, powder coated GI sheet metal cabinets, all hardware of anti-rust quality, conformal coating on PCB to protect from duct & humidity, hydrophilic blue fin material for better

corrosion resistance with Brushless DC Motor only. Outdoor Units shall be top discharge type or as per site requirement. Brief design parameters of VRF units shall be as under:

Maximum Ambient Temperature	45 °C
Refrigerant	R410A / R407C / Eco friendly
Compressor Type	All inverter Hermetic/Semi-hermetic Scroll
Min. COP	As per ASHRAE 90.1 latest Standard

- b) VRF outdoor unit must have bigger condenser coil face area with higher capacity fan resulting in improved efficiency, less deration due to higher ambient temperatures.
- c) Each outdoor unit shall consist of single / multiple full Inverter Scroll Compressor. There should not be any fixed compressor or Partial inverter.
- d) The VRF system must compatible with R410A / R407C / Eco friendly green Refrigerant only. System must be pre-charged at Factory. If required additional, based on the site, then it will be charged additional at site.
- e) All Inverter VRF must be designed with the new generation Refrigerant Cooled PCB, which helps maintain the drive within allowable temperature range. It enhances the reliability of the system when it is working under very high ambient conditions.
- f) Each indoor unit must be connected (with VRF outdoor unit) by means of individual Copper Refrigerant network or Y distribution joints only. The mentioned “Y” joint or refnet joints must factory make & tested by OEM. The individual size of refnets or

“Y” joints connecting to individual indoor units, to be calculated & supplied by OEM / Bidder / OEM approved bidder only.

- g) All Inverter VRF should have emergency back operation. In-case of double compressor ODUs, it must operate or function even if there is a failure or maintenance downtime of one compressor.
- h) In modular VRF, where multiple units have been combined to run, as one larger unit, the system must operate even in case of failure or maintenance downtime or shutdown of one VRF ODU. It will help to ensure that cooling remains largely unaffected even during servicing.
- i) As all the indoor units are interconnected by the communication cable, if there is any break in any communication cable, subsequent IDUs are affected and must not function. By activating the IDU emergency operation on the Next Generation All Inverter VRF, the other IDUs must function despite of such break.

j) Indoor Units:

**Ductable Indoor Unit** – Ceiling suspended double skinned AHU, compatible with VRF outdoor units, shall consist of the following and having extruded Aluminium section frame construction, Outer Skin with 0.6 mm thick Pre-coated GI, Inner Skin with 0.6 mm thick Plain GI, Insulation with 25 mm thick PUF of density 40kg/ Cu. Mtr. AHU shall also consists with the following:

- Fan Section with Forward/Backward curve fan having required capacity of TEFC Sq. Cage Induction Motor (EFF-1)
- Coil Section with 6 Row deep DX Cooling Coils
- Filter Section comprises of Washable Pre-filter (Efficiency 90% down to 10 Microns)
- Sandwich Drain Pan with 25mm thick PUF injection in between 22G SS Inner & 24G GI Outer Sheet

**Cassette type Indoor Unit** - The indoor units shall be ceiling suspended 4-way cassette type with electronic expansion valve, inbuilt drain connections, stainless



steel (18G) drain pan with PUF insulation, drain pump, pre-filter, fan section, DX cooling coil section & wireless remote.

#### 3.1.4 DX TYPE AIR-COOLED PRECISION AIR-CONDITIONING UNIT

The air-conditioning unit shall be designed specifically for high sensible heat ratio applications such as Network Room & Data Centre.

Each unit shall be capable of providing sensible cooling capacities at rated ambient temperatures with adequate airflow. Each unit shall be capable of providing actual cooling capacity as mentioned in the Specification.

The system shall contain Scroll compressor, Evaporator, Humidifier, Condenser and Thermostatic / Electronic Expansion valve, all of which shall be contained within the cabinet of the unit. Brief design parameters shall be as under:

Maximum Ambient Temperature	45 °C
Refrigerant	R410A / R407C / Eco friendly
Compressor Type	Hermetic/Semi-hermetic Scroll
Min. COP	As per ASHRAE 90.1 latest Standard

#### **Cabinet Construction**

The frame shall be constructed of Galva bond steel & shall be Single/double skin type. Frame should be designed in such a way that Noise level will be in the given range and panel shall be fitted in such a way to service from the front would be easy for the service point.

#### **Filtration**

The filter chamber shall be an integral part of the system and withdraw able from the front of the unit. The filter should be of 5 micron filtration Capacity & efficiency level shall be above 90%.

#### **Fans**

The fans shall be located downstream of the evaporator coil and be of the forward /backward curved centrifugal type, double width, double inlet and statically and dynamically balanced to G6.3 DIN ISO 1940 part I. Each fan shall be separately driven by a high efficiency electric motor. The assembly of the whole fan section shall be designed to facilitate all servicing requirement.

### **Electrical Heating**

The electric heating elements shall operate at a heat density level not exceeding 60 kW/m<sup>2</sup>. The low watt density elements shall be of finned tubular steel construction finished in high temperature paint. The heating circuit shall include dual safety protection through loss of air and manual reset high temperature controls.

### **Scroll Compressor**

The compressor shall be of the high efficiency complaint scroll design with an E.E.R. (energy efficiency ratio) of not less than 3.25 at ARI rating conditions. The compressor shall be charged with mineral oil and designed for operation on R410a/R407c. Each compressor shall have internal motor protection and be mounted on vibration isolators.

### **Refrigeration Circuit**

The refrigeration system shall be of the Single circuit direct expansion type and incorporate hermetic scroll compressors, complete with crankcase heaters. Cooling steps shall be a maximum of 50% of total unit cooling capacity for one and two compressor models. The system shall include a manual reset high pressure control; auto reset low temperature switch, thermostatic / electronic expansion valve, high sensitivity refrigerant sight glass, large capacity filter drier and charging/access ports in each circuit. Each refrigeration circuit shall include rigidly mounted isolation valves in the discharge and liquid lines to aid servicing and installation.

### **Evaporator Coil**

The evaporator coil shall be draw-through type air design for uniform air distribution. The coil shall be constructed of rifled bore copper tubes and louvered aluminum fins, with the frame and drip tray fabricated from heavy gauge aluminum. All metal parts in contacts with condensate shall be the same material to prevent electrolytic corrosion. The drip trays shall ensure the collection of condensate and be accessible for cleaning.

**Dehumidification**

Dehumidification function shall operate only when actually required, without reduction in the airflow rate and ensure uniform air distribution & Avoids sudden variation in supply air & room air temperature.

**Remote Air Cooled Condenser**

The air-cooled condenser shall be the low profile, weatherproof type incorporating high efficiency, direct drive, external rotor motors with axial blade fans. The condenser shall be constructed from heavy-duty aluminums and corrosion resistant components. Heavy duty mounting legs and all assembly hardware shall be included. Condensers shall be suitable for 24-hour operation and be capable of providing vertical or horizontal discharge.

**Fan Speed Control Condenser**

The condenser fans shall be directly driven by 4 pole 1210 rpm 230 volt 50 hz electric motors with an IP54 enclosure rating and class F insulation. The motor shall be equipped with permanently sealed ball bearing and high temperature grease. The motors shall be speed controlled to ensure stable operating conditions from 5 degC to 45 degC ambient by a factory fitted, direct acting pressure actuated fan speed controller. The control system shall be complete with input isolation switch, transducers and pressure switches.

The highperformance heat exchanger shall include mechanically expanded crosshatched copper tubes and louvered aluminum form maximum heat transfer. The coil shall be finished in a high temperature modified epoxy coating to offer increased protection in aggressive environments. The face velocity of coil shall not be more than 2.9 m/s.

**Unit Controller**

The unit controller shall be microprocessor based and include a large LCD backlit graphic display for clear visibility of text and graphics. The display and control buttons shall be accessible from the unit front without removing any external panels.

The controller shall have a user-friendly menu driven interface with supporting help screens. In normal operating mode screen shall display unit number, temperature and

relative humidity set points and actuals, graphs, time, date and operating status. Dynamic icons identify the system operating mode. A 48-hour real time log of temperature and humidity data shall be retained by the control system. All parameters and data shall be protected in memory by an onboard battery.

### **Control**

The control system shall allow programming of the following conditions:

- Temperature set point
- High Temperature Alarm
- Low temperature Alarm

The control system shall include the following settable features:

- Unit identification number.
- Startup Delay, Cold start Delay and Fan Run on timers
- Sensor Calibration.
- Remote shutdown & general Alarm management
- Compressor Sequencing.
- Return temperature control.
- Choice of Modulating output types.

### **Alarms**

The microprocessor shall activate an audible, visual and general alarm in the event of any of the following conditions:

- High Temperature
- Low Temperature
- Loss of Air
- High Pressure
- Low Pressure
- Overload tripping of all components

#### 3.1.5 Refrigerant piping:

- i. The Refrigerant pipe material shall be of hard seamless copper tubes with pipes material being hard drawn copper pipe. Forged copper fittings shall be used for the refrigerant piping. The refrigerant piping arrangements shall be in accordance with good engineering practice as applicable to the air-conditioning industry, and shall include charging connections, suction line insulation and all other items normally forming part of proper refrigerant circuits except Y- joint/separation tubes.
- ii. Before joining any copper pipe or fittings, its internals shall be thoroughly cleaned by passing a clean cloth via wire or cable through its entire length. The piping shall be continuously kept clean of dirt etc. while constructing the joints. Subsequently it shall be thoroughly blown out using nitrogen gas.
- iii. After completion of installation of the refrigerant piping, the refrigerant piping system shall be pressure tested using nitrogen gas at a suitable pressure as specify by OEM (Original Equipment Manufacturer). Pressure shall be maintained in the system for 48 hours. The system shall then be evacuated to a vacuum of not less than 700 mm Hg and held for 24 hours.
- iv. The supplier of air-conditioning system shall choose sizes as designed and erect proper interconnections of the complete refrigerant circuit the thickness of copper piping shall not be less than 18 SWG for pipes upto 19.1 mm and 16 SWG for larger dia.
- v. The suction line pipe size and the liquid line pipe sizes shall be selected according to the manufacturer's specified diameter. All refrigerant pipes shall be properly supported and anchored to the building/structure using steel hangers, fastener, brackets and supports from the building/structure.
- vi. The refrigerant piping should be laid in such a way that it should not distort the interior of the room, wherever the refrigerant pipe has to be laid across the room, it should be laid in a concealed manner by making appropriate boxing arrangement matching with the interior of the room. All associated minor Civil Engineering works (like chasing on wall, ceiling & re-plastering and repainting etc.) related with the above items are to be included.

- vii. Entire liquid and suction refrigerant pipe lines including all fittings, valves and strainer bodies etc. Shall be insulated with 19-mm/ 13 mm thick elastomeric Nitrile rubber as applicable.

3.1.6 Fresh air shall be drawn by means of intake air louvers through pre- filters. The air filter shall be 3 Ply HDPE (pleated construction) with GI/Aluminum frame of preferable size 610 x 610 x 50 mm thick. The filter shall be housed in a frame with GI intake louver. The efficiency of filter shall be 90% down to 10 micron dust. The face velocity of filter shall not be more than 2.5 m/s. The quantities of the filters shall be as per the fan capacity envisaged.

3.1.7 Insulated condensate drain from each indoor unit shall be terminated to the nearest drain/nearby pantry/ toilet wash basin block/risers at each floor.

### 3.2 VENTILATION SYSTEM

#### 3.2.1 AREAS TO BE VENTILATED

Dry type mechanical ventilation system shall be considered for different areas at individual floors, as mentioned below:

Sl. No.	Location	Air Qty (CMH)	SP (mm WC)	Qty (Nos.)	Type of Exhaust Fan
<b>1.0</b>	<b>Gr Floor</b>				
	Services Room	2,500	15	2	Tube axial exhaust air Fan
<b>2.0</b>	<b>Electrical Rooms - 1<sup>st</sup> to 4<sup>th</sup> Floors</b>				
	Electrical Rooms – 4 Nos.	500	Free Delivery	4	Propeller type exhaust air Fan
<b>3.0</b>	<b>Toilets - Gr to 4<sup>th</sup> Floors</b>				
	Toilets – 5 Nos.	500	Free Delivery	5	Propeller type exhaust air Fan

**Notes:**

1. Capacity of Ventilation fans mentioned above are indicative & for reference only. Exact capacity & quantity of each fan shall be finalised based on detail load calculations during engineering stage, to be submitted by the Contractor, as per latest architectural drawings and equipment heat loads of respective area.
2. Static pressure of exhaust air fans shall be calculated by the Contractor based on layout drawing & to be submitted for approval during engineering stage.
3. Any additional area requiring ventilation as per architectural drawings during engineering stage, shall be considered without any price implications.

### 3.2.2 EQUIPMENT SPECIFICATION

#### a) TUBE AXIAL FAN

Tube axial fans (variable pitch type) shall be of mild steel construction conforming to IS: 2062 (Gr. A) and casing thickness shall be 3 mm thick (min), industrial type with motor directly coupled to the impeller. The impeller shall be statically and dynamically balanced. These fans shall be supplied complete with cast aluminum alloy impeller, steel casing, motor, supports for total unit and other related accessories as required for the system such as fan fixing connection piece, fan fixing plates and supports etc. All fans shall be AMCA certified.

#### b) PROPELLER FAN

Propeller fan shall be direct-driven, three or four blade type, mounted on a steel mounting plate with orifice ring. Mounting Plate shall be of steel construction, square with streamlined venture inlet (reversed for supply applications) coated with baked enamel paint. Mounting plate shall be of standard size, constructed of 12 to 16 gauge sheet steel depending upon the fan size.

Fan blades shall be constructed of aluminium or steel. Fan hub shall be of heavy welded steel construction with blades bolted to the hub. Fan blades and hub assembly shall be statically and dynamically balanced at the manufacturer's works. Shaft shall be of steel, accurately ground and shall be of ample size for the load transmitted and shall not pass through first critical speed thru the full range of specified fan speeds. Fans shall be provided with gravity louvers.

#### c) AIR INTAKE GRILLES/LOUVERS

Air intake grilles/louvers shall be provided for supply air inlet at the lower level of respective doors. The grilles/louvers shall consist of parallel metallic blades suitable for door fittings.

d) COWL WITH BIRD SCREEN

Cowl with bird screen shall be provided for exhaust air fans. Bird screen of 10 sq.mm and minimum 16 G wire mesh shall be provided on the outer face. Gravity louver dampers shall be provided for all the exhaust fans.

**3.3 DUCTWORK & INSULATION**

**3.3.1 DUCTWORK**

- All galvanized steel ductwork shall conform to IS:655 / SMACNA as applicable & shall have minimum zinc deposition of 180 gm/sq.m or better as per IS:277. All duct seams shall be filled with bitumastic cold emulsion or equivalent vapor seal.
- All duct supports shall be provided at centre preferably not exceeding 2.5 Meter. The duct supports shall consist of structural steel angles and if required flats and jointed by bolting. Whenever duct support angles are to be fixed with reinforced concrete roof/floor slab, the anchoring screw shall be connected with duct support angles by means of intermediate angle plates with bolted connection, so as to facilitate early erection and dismantling. All items of duct support including MS rods, MS angles, double angles, auxiliary or special steel members, hooks, dash fasteners and all other supporting material required shall be provided by the BIDDER.
- Fire proof Canvas or equal flexible connection shall be provided at each connection between duct work and AHU so as to isolate vibration.
- Splitters & dampers shall be provided for equipment/area isolation & for proportional volume control of air. The same shall be min 16 gauge GS sheet of quadrant type with suitable locking device, mounted outside the duct in accessible position.
- Suitable vanes shall be provided in the duct collar to have uniform & proper air



distribution.

- Coating shall be of approved colour to match interiors.
- Selection and placing of diffusers, grilles etc. shall be by the Contractor matching the lighting fitting and the décor of the respective area.

### 3.3.2 INSULATION

#### **Duct Thermal Insulation**

Supply and return air sheet metal ducting shall be thermally insulated with Factory Pasted Al. Foil Faced Fire retardant 19 mm thick Closed Cell Nitrile Rubber Insulation (UL/FM approved) with necessary Adhesive as recommended by the Manufacturer. Thermal conductivity of the insulation material shall not exceed 0.038 W/m<sup>o</sup>K or 0.212 BTU / (Hr-ft<sup>2</sup>-°F/inch) at an average temperature of 30°C. Density of the nitrile rubber shall be 40-60 Kg/m<sup>3</sup>.

#### **Duct Acoustic Insulation**

The supply air ducting from the outlet of each AHU up to 6 meters will be acoustically insulated from inside with 10mm thick Open Cell Nitrile Rubber insulation on the ducts after applying two coats of cold setting adhesive (CPR X compound), to maintain noise level as mentioned.

The insulating material shall have ODP (Ozone Depletion Potential) and GWP (Global Warming Potential) of Zero.

#### **Roof Insulation**

Underdeck insulation shall be provided by the Contractor for the exposed roof of the air-conditioned spaces. Underdeck insulation shall be 50mm thick TF Quality expanded polystyrene (32 Kg/m<sup>3</sup>) or 30mm thick phenotherm or equivalent thermobreak material. Underdeck surface of ceiling shall be cleaned and made dirt free. Insulation panels shall be pasted on this surface with black CPRX compound. 28g wire net shall be tightened around insulation so as to avoid any kind of sagging. Ends of net shall be overlapping by at least 25mm. Overlaps shall be screwed with galvanised screws to avoid rusting.

### 3.3.3 DAMPERS, GRILLS, DIFFUSERS

- All ducted indoor units shall have fusible link type fire damper as per UL 555 for 90 minutes rating for supply/ return duct (as applicable). Fire dampers shall be provided wherever duct crosses any wall / roof to isolate the respective AC unit in the event of fire. The space around the ducts and refrigerant / drain pipes shall be sealed with fire retardant material.
  
- All supply air grills / diffusers of air-conditioned areas shall be provided with volume control dampers.
  
- The grills / diffusers will be of extruded aluminium powder coated.

## 4.0 **PERFORMANCE GUARANTEE**

### 4.1 GENERAL

All equipment and systems of the Air-conditioning & Ventilation system shall be guaranteed for workmanship & materials and satisfactory performance for a period of 12 months from the date of successful commissioning/ handing over. The guarantee for performance shall cover individual items/units and systems including electrics for their rated outputs as well as for integrated operations of the entire Air-conditioning & Ventilation system.

### 4.2 PERFORMANCE GUARANTEE PARAMETERS

- a) Actual Capacity at site for each AC & Ventilation equipment measured for a period of at least 7 days
- b) Total Power Consumption at design conditions / part load conditions
- c) Actual Capacity of each system at design conditions/simulated operating conditions
- d) Noise level
- e) Vibration level

### 4.3 OVERALL PERFORMANCE:

At an appropriate time in consultation with purchaser the successful Bidder shall demonstrate performance at rated capacity over a period of 6 working days on continuous operating hours.

Contractor will furnish performance guarantee for Air Conditioning & Ventilation System in respect of all items listed in Table below. The values indicated in Table below and the guaranteed performance curve will be the basis for evaluation of the performance tests by the Owner and/or acceptance of the equipment.

The following Performance Guarantees shall be confirmed by the Bidder:

<b>SI. No</b>	<b>Particulars</b>	<b>Value</b>
1.0	Actual Capacity at site condition for each AC & Ventilation equipment	To be indicated by the Bidder
2.0	Electrical power consumption of each AC unit	To be indicated by the Bidder
3.0	Electrical shaft power of each ventilation unit	To be indicated by the Bidder
4.0	Noise level of each equipment	As per Spec
5.0	Vibration level of each rotating equipment	As per ISO Standard

Performance guarantees under correction

The following items of performance on air conditioning system shall be guaranteed under correction with instrument tolerances as specified below:

<b>SI. No</b>	<b>Particulars</b>	<b>Value</b>
---------------	--------------------	--------------

Sl. No	Particulars	Value
1.0	Room inside temp. of each air-conditioned space	± 1.0%
2.0	Shaft power of each motor	± 1.0%
3.0	Noise level	85 dBA at 1.5 m distance of any rotating equipment & 65 dBA at 1.5 m distance at supply air grilles inside AC space
4.0	Vibration level	As per zones A and B of ISO 10816-1

**Note:**

The values indicated by the Bidder should be the minimum guaranteed values without any negative tolerance.

4.4 **MANPOWER**

The manpower to be utilized for demonstration of performance guarantee shall be arranged by the Bidder.

4.5 **MODIFICATIONS OF DEFECTS**

If the tests specified above show that the performance of Air-conditioning & Ventilation system has failed to achieve all the guaranteed parameters or some of them, the successful Bidder shall rectify the defects and carry out modifications if necessary to meet the guaranteed figures and the guarantee tests shall be repeated at no extra cost.

However, protocol on this subject jointly agreed by the Purchaser and the successful Bidder will be prepared before the performance guarantee test.

5.0 **DATA TO BE FURNISHED ALONG WITH THE BID**

5.1 **GENERAL**

- Write-up on technical features of equipment offered.
- Filled-in Data Sheet as called for in the Technical Specification.
- Actual user's performance certificates in respect of equipment of systems covered under contract.
- Name of manufacturers of all major mechanical equipment.
- Operation & maintenance requirements for next five (05) years.
- List of recommended spare parts with price list.
- Bar Chart/PERT Network schedule incorporating the following major activities
  - (i) Design and Engineering
  - (ii) Supply of equipment and accessories
  - (iii) Erection schedule
  - (iv) Testing and commissioning schedule

## 5.2 MECHANICAL

- Offer shall be submitted as per enquiry specification.
- Duly filled-in and stamped Data Sheets for all HVAC equipment.
- VRF selection with product catalogue.
- Confirmation of outdoor unit location & space provided.
- Equipment Selection and schedule with model no. make and Motor List.
- List of deviations if any.
- Experience list for similar type of equipment supplied, which should indicate the name of customer, date of ordering, date of commissioning.

## 6.0 **DATA TO BE FURNISHED AFTER AWARD OF CONTRACT**

Successful Bidder to submit following document after award of contract for approval of Purchaser:

- a) List of drawings/documents to be submitted for review, approval and information with scheduled submission dates.
- b) Detail Heat Load Calculations for Air conditioning & Ventilation systems.
- c) Air-conditioning Layout drawings of each floor.
- d) Ventilation Layout drawings of each floor / area.
- e) Air-conditioning schematic layout.

- f) Refrigerant piping layout drawings for each AC system.
- g) GA drawings, Data Sheets of each equipment.
- h) Equipment Schedule with Electrical Load List.
- i) Vibration isolator selection, inertia block selection, sound attenuator selection, equipment sound power level and sound pressure level data.
- j) Quality Assurance Plan (QAP)
- k) PG test procedure.
- l) Internal inspection documents/test reports of equipment before despatch clearance.
- m) Billing schedule.

In addition to this, Bidder shall provide sample for the following items along with catalogue and sample approval must be taken before procurement of items:

- a) Grilles, Diffusers.
- b) Volume control dampers.
- c) Fire dampers.
- d) Thermal insulation for ducts as well as refrigerant pipes.

TCE-10477A-PS-  
6172-60541- P0

**TATA CONSULTING ENGINEERS LIMITED**

SECTION:  
REV

**WATER SUPPLY, SANITARY & DRAINAGE WORKS**

SHEET i OF ii

**TECHNICAL SPECIFICATIONS**

**WATER SUPPLY, SANITARY AND DRAINAGE WORKS  
FOR PROPOSED ICC**

## Contents

<b>Clause</b>	<b>Title</b>
1	Scope
2	Scaffolding
3	Protection
4	Guarantee
5	Applicable Codes, Standards and Publications
6	Quality Assurance and Quality Control
7	Sanitary and other Appliances
8	Soil, Waste, Vent and Rain water pipe
9	Drainage
10	Water Supply System
11	Pumps



TCE-10477A-PS-1000 C	<b>TATA CONSULTING ENGINEERS LIMITED</b>	SECTION: WRITE-UP
	<b>WATER SUPPLY, SANITARY &amp; DRIANGAE WORK</b>	SHEET 1 OF 71

1.0 **SCOPE**

1.1 This specification covers the general requirements of providing and laying water mains and water supply piping and providing and laying drainage lines.

1.2 For specifications, mode of measurements and scope of work covered under the respective items for the work included under this contract, following documents shall be referred to in the order of precedence as given below:

- (a) Description of the items and notes if any given in the Schedule of Quantities.
- (b) Drawings
- (c) Specifications.
- (d) Additional/ Special Conditions of Contract.
- (e) General Conditions of Contract.
- (f) Applicable Codes and Standards as specified herein with amendments/ revisions issued till date.

In the event of any discrepancy among the documents referred above, the document in the higher order of precedence shall prevail.

1.3 In the event of any element of specification not being available in any of the documents mentioned above, the instructions of the Engineer in writing shall be followed by the Contractor.

1.4 The Work shall be carried out in accordance with the drawings and designs as would be issued to the Contractor by the Engineer duly signed and stamped by him. The Contractor shall not take cognisance of any drawings, designs, specifications, etc. not bearing Engineer's signature and stamp. Similarly, the Contractor shall not take cognisance of instructions given by any other Authority except the instructions given by the Engineer in writing.

1.5 The Work shall be executed and measured as per metric dimensions given in the Schedule of Quantities, drawings, etc.

1.6 The Contractor shall acquaint himself fully with the partial provisions for supports that may be available in the structure and utilise them to the extent possible. In any case the Contractor shall provide all the supports regardless of provisions that have been already made. Nothing extra shall be payable for situations where bed plates (for supports) are not available or are not useful.

1.7 The Contractor shall incorporate seismic considerations of anchoring and isolation in the design of the systems as per the requirements of the different equipment.

1.8 Shop coats of paint that may be damaged during shipment or erection shall be cleaned off with mineral spirits, wire brushed, and spot primed over the affected areas, then coated with paint to match the finish over the adjoining shop painted surface.

1.9 In addition to the sectional testing carried out during the construction, the Contractor shall test the entire installation after connections to the overhead tanks or pumping system or mains. He shall rectify all leakage and shall replace all defective materials in the system. Any consequential damage done to the building, furniture and fixtures on account of Contractor's

ISSUE P0
-------------

TCE-10477A-PS-1000 C	<b>TATA CONSULTING ENGINEERS LIMITED</b>	SECTION: WRITE-UP
	<b>WATER SUPPLY, SANITARY &amp; DRIANGAE WORK</b>	SHEET 2 OF 71

carelessness, like open or burst pipes or failure of fittings during testing and commissioning shall be made good by the Contractor at no additional cost.

2.0 **SCAFFOLDING**

2.1 Only steel tube scaffolding of approved design shall be used for all works. The scaffold structure shall comply with the requirements of IS: 4014 and IS: 3696. An independent tied scaffold (single and double scaffold), which has two lines of standards, shall be provided with the inner line kept at least one board clear of the finished face with extended transoms, or hop up baskets to carry an inside board. Diagonal braces shall not prevent the material being moved along the scaffold run. The scaffolding shall be suitably packed at the ends to prevent damage to the finished work.

3.0 **PROTECTION**

3.1 Protection against damage: Care shall be taken to avoid damage from any cause at all stages. Packing pieces used for protection shall not disfigure or otherwise permanently mark the Works.

3.2 Surface protection shall be afforded by careful handling and the avoidance of the use of hooks, crowbars, or other implements that are likely to damage the works.

3.3 During installation of piping, open end of pipe shall be protected with temporary cover to prevent dust or other materials entering it.

3.4 Protection during construction: Decorative surfaces shall be carefully protected during construction by providing a temporary cover.

3.5 Protection of finished work: At all stages of the Contract it is essential that all works are properly protected.

3.6 Suitable packing shall be used to ensure that scaffolding does not damage erected stone, marble, granite or other finished works.

3.7 Any disfigurement, discolouration or imperfection whatsoever due to any reason shall not be accepted and the Contractor shall either remedy the same or redo the work at no extra cost. The decision of the Engineer as to whether any work either in whole or in part is acceptable or not shall be final and binding on the Contractor.

4.0 **GUARANTEE**

4.1 The Contractor shall guarantee and undertake to maintain and rectify the various components of the Plumbing work installed by him for successful performance for a period as indicated elsewhere in the tender/ contract document. The Contractor shall indemnify the Engineer for a similar period against any damage to property and injury to persons on account of any defective work or maintenance carried out by the Contractor. The format and text of the Guarantee and the Indemnity Bond shall be given by the Engineer.

5.0 **APPLICABLE CODES, STANDARDS AND PUBLICATIONS**

5.1 All equipment, supply, erection, testing and commissioning shall comply with the requirements of Indian Standards and code of practices given below as amended till date. All equipment and material being supplied by the

ISSUE P0
-------------

Contractor shall meet the requirements of IS and other Codes/ Publications as given below.

SP: 6 (1)	Structural steel sections.
IS: 325	Three phase induction motors.
IS: 554	Dimensions for pipe threads where pressure tight joints are required on the threads
IS:694	PVC insulated cables for working voltages up to and including 1100 V.
IS: 779	Specification for water meters (domestic type).
IS: 800	Code of Practice for general construction in steel.
IS: 1068	Electroplated coatings of nickel plus chromium and copper plus nickel plus chromium.
IS: 1172	Code of Basic requirements for water supply drainage and sanitation.
IS: 1367 (Part 1)	Technical supply conditions for threaded steel fasteners: General Requirements.
IS: 1367 (Part 2)	Technical supply conditions for threaded steel fasteners: Tolerances for fasteners – Bolts, screws, studs and nuts – Product Grades A, B and C.
IS: 1554 (Part 1)	PVC insulated (heavy duty) electric cables: For working voltages up to and including 1100 V.
IS: 1554 (Part 2)	PVC insulated (heavy duty) electric cables: For working voltages from 3.3 kV up to and including 11 kV.
IS: 1726	Specification for cast iron man hole covers and frames.
IS: 1742	Code of practice for building drainage.
IS: 2065	Code of practice for water supply in buildings.
IS: 2104	Specification for water meter boxes (domestic type).
IS: 2373	Specification for water meters (bulk type).
IS: 2379	Colour code for identification of pipelines.
IS: 2527	Code of practice for fixing rain water gutters and down pipes for roof drainage.
IS: 2629	Recommended practice for hot dip galvanizing on iron and steel.
IS: 3114	Code of practice for laying of cast iron pipes.
IS: 4111 (Part 1)	Code of practice for ancillary structures in sewerage system: Manholes.
IS: 4127	Code of practice for laying glazed stoneware pipes.
IS: 4853	Recommended practice for radiographic inspection of fusion

	welded butt joints in steel pipes.
IS: 4985	Unplasticised PVC pipes for potable water supplies - specification.
IS: 5329	Code of practice for sanitary pipe work above ground for buildings.
IS: 5455	Cast iron steps for manholes.
IS: 6159	Recommended practice for design and fabrication of material prior to galvanising.
IS: 7558	Code of practice for domestic hot water installations.
IS: 8321	Glossary of terms applicable to plumbing work.
IS: 9668	Maintenance of water supplies and fire fighting.
IS: 9842	Preformed fibrous pipe insulation.
IS: 9912	Coal tar-based coating materials and suitable primers for protecting iron and steel pipe lines.
IS: 10221	Code of practice for coating and wrapping of underground mild steel pipelines.
IS: 10234	Recommendations for general pipeline welding.
IS: 10446	Glossary of terms relating to water supply and sanitation.
IS: 11149	Rubber Gaskets.
IS: 11790	Code of practice for preparation of butt-welding ends for pipes, valves, flanges and fittings.
IS: 12183 (Part 1)	Code of practice for plumbing in multi-storeyed buildings: Water Supply.
IS: 12251	Code of practice for drainage of building basements.
BS: 5572	Code of practice for sanitary pipe work.
BS: 6700	Specification for design, installation, testing and maintenance of services supplying water for domestic use within buildings and their curtilages.
BS: 8301	Code of practice for building drainage.
BSEN274	Sanitary tap ware, waste fittings for basins, bidets and baths. General technical specifications.
IS: 458	Specification for precast concrete pipes(with and without reinforcement).
IS:651	Salt glazed stoneware pipes and fittings.
IS: 1239 (Part 1)	Steel tubes, tubulars and other wrought steel fittings: Steel tubes.
IS: 1536	Centrifugally cast (spun) iron pressure pipes for water, gas and sewage.

IS: 1538	Cast iron fittings for pressure pipes for water, gas and sewage.
IS: 1729	Sand cast iron spigot and socket soil, waste and ventilating pipes, fitting sand accessories.
IS: 1879	Malleable cast iron pipe fittings.
IS: 1978	Line pipe.
IS: 1979	High test line pipe.
IS: 2501	Copper tubes for general engineering purposes.
IS: 2643 (Part 1)	Dimensions for pipe threads for fastening purposes: Basic profile and dimensions.
IS: 2643 (Part 2)	Dimensions for pipe threads for fastening purposes: Tolerances.
IS: 2643 (Part 3)	Dimensions for pipe threads for fastening purposes: Limits of sizes.
IS: 3468	Pipe nuts.
IS: 3589	Seamless or electrically welded steel pipes for water, gas and sewage (168.3 mm to 2032 mm outside diameter).
IS:3989	Centrifugally cast (spun) iron spigot and socket soil, waste and ventilating pipes, fittings and accessories.
IS: 4346	Specifications for washers for use with fittings for water services.
IS: 4711	Methods for sampling steel pipes, tube sand fittings.
IS: 6392	Steel pipe flanges.
IS: 6418	Cast iron and malleable cast iron flanges for general engineering purposes.
IS: 7181	Specification for horizontally cast-iron double flanged pipes for water, gas and sewage.
IS: 778	Specification for copper alloy gate, globe and check valves for water works purposes.
IS: 780	Specification for sluice valves for water works purposes (50 mm to 300 mm size).
IS: 1703	Specification copper alloy float valves (horizontal plunger type) for water supply fittings.
IS: 2906	Specification for sluice valves for water works purposes (350 mm to 1200 mm size).
IS: 3950	Specification for surface boxes for sluice valves.
IS: 5312 (Part 1)	Specification for swing check type reflux (non-return) valves: Single door pattern.

IS: 5312 (Part 2)	Specification for swing check type reflux (non-return) valves: Multidoor pattern.
IS:12992 (Part 1)	Safety relief valves, spring loaded: Design.
IS: 13095	Butterfly valves for general purposes.
IS: 1700	Specification for drinking fountains.
IS: 2692	Specification for ferrule for water services.
IS: 5961	Specification for cast iron gratings for drainage purposes.
EN Norms	EN Norms for Drainage, water supply and pluvia

## 6.0 QUALITY ASSURANCE AND QUALITY CONTROL

- 6.1 The Work shall conform to high standards of design and workmanship, shall be structurally sound and aesthetically pleasing. Quality standards prescribed shall form the backbone for the Quality Assurance and Quality Control system.
- 6.2 At the site level the Contractor shall arrange the materials, their stacking/storage in an appropriate manner to ensure quality. Contractor shall provide equipment and manpower to test continuously the quality of materials, assemblies, etc. as directed by the Engineer. The test shall be conducted continuously, and the result of tests maintained. In addition, the Contractor shall keep appropriate tools and equipment for checking alignments, levels, slopes and evenness of surface.
- 6.3 The Engineer shall be free to carry out tests as may be considered necessary by him at his sole discretion, from time to time, in addition to those specified in this document. The Contractor shall provide the samples and labour for collecting the samples. Nothing extra shall be payable to the Contractor for samples or for the collection of the samples.
- 6.4 The test shall be conducted at the site laboratory that may be established by Engineer or at any other Standard Laboratory selected by Engineer.
- 6.5 The Contractor shall transport the samples to the laboratory for which nothing extra shall be payable. In the event of Contractor failing to arrange transportation of the samples in proper time Engineer shall have them transported and recover at two times the actual cost from the Contractor's bills.
- 6.6 Testing charges shall be borne by the Contractor.
- 6.7 Testing may be witnessed by the Contractor or his authorised representative. Whether witnessed by the Contractor or not, the test results shall be binding on the Contractor.

## 7.0 SANITARY WARE AND OTHER APPLIANCES

### 7.1 SCOPE OF WORK

Without restricting to the generality of the foregoing, sanitary and other appliances shall inter-alia include the following:

- (a) Sanitary appliances and fixtures for toilets.
- (b) Chromium plated brass fittings.

TCE-10477A-PS-1000 C	<b>TATA CONSULTING ENGINEERS LIMITED</b>	SECTION: WRITE-UP
	<b>WATER SUPPLY, SANITARY &amp; DRIANGAE WORK</b>	SHEET 7 OF 71

- (c) Stainless steel sinks.
- (d) Accessories e.g. towel rods, toilet paper holders, soap dish, liquid soap dispensers, towel rails, coat hooks, etc.
- (e) Mirrors, hand driers, drinking water fountains, etc.

Whether specifically indicated or not the Contractor shall provide for all appliances and fixtures, all fixing devices, nuts, washers, Teflon tape, sealant, cement, brackets, supports, paints, connectors, Chromium Plated (CP) riser pipes, adapters, bolts, screws, hangers, etc., as required.

All exposed pipes within toilets and near appliances/ fixtures shall be of CP brass or copper unless otherwise specified.

## 7.2 GENERAL REQUIREMENTS

- 7.2.1 All materials shall be new and of quality conforming to specifications and subject to the approval of the Engineer. Wherever particular makes are mentioned, the choice of selection shall remain with the Engineer.
- 7.2.2 All appliances, fixtures and fittings shall be provided with all such accessories as are required to complete the item in working condition whether specifically mentioned or not in the Schedule of Quantities, specifications, and drawings. Accessories shall include proper fixing arrangement, brackets, nuts, bolts, washers, screws and required connection pieces.
- 7.2.3 Fixing screws shall be half round head CP brass screws, with CP brass washers unless otherwise specified.
- 7.2.4 Porcelain sanitary ware shall be glazed vitreous china of first quality free from warps, cracks and glazing defects conforming to IS: 2556. The choice of the colour of the Sanitary ware shall be that of the Engineer and nothing extra shall be payable to the Contractor for fixing of Sanitary ware of any colour.
- 7.2.5 CP fittings shall be cast brass CP of the best quality approved by the Engineer.
- 7.2.6 If Supply of sanitary appliances, fixtures are fittings are in Owner's scope, Contractor shall ensure that no damages occur to the same during shifting, transportation, installation and successful handing over. If any damage occurs, the same shall be replaced by the Contractor at his own cost.
- 7.2.7 All appliances, fittings and fixtures shall be fixed in a neat workmanlike manner true to level and to heights shown on the drawings and in accordance with the manufacturer's recommendations. Care shall be taken to fix all inlet and outlet pipes at correct positions. Faulty locations shall be made good and any damage to the finished floor, tiling, plaster, paint, insulation or terrace shall be made good by the Contractor at his own cost.
- 7.2.8 All materials shall be rust proofed; materials in direct or indirect contact shall be compatible to prevent electrolytic or chemical (bimetallic) corrosion.
- 7.2.9 Sanitary appliances, subject to the type of appliance and specific requirements, shall be fixed in accordance with the relevant standards and the following:
  - (a) Contractor shall, during the entire period of installation and afterwards protect the appliances by providing suitable cover or any other protection to absolutely prevent any damage to the appliances until

ISSUE P0
-------------

satisfactory handing over. (The original protective wrapping shall be left in position for as long as possible).

- (b) The appliance shall be placed in correct position or marked out in order that pipe work can be fixed or partially fixed first.
- (c) The appliance shall be fixed in a manner such that it will facilitate subsequent removal, if necessary.
- (d) All appliances shall be securely fixed. Manufacturers' brackets and fixing methods shall be used wherever possible. Compatible rust proofed fixings shall be used. Fixing shall be done in a manner that minimises noise transmission.
- (e) Appliances shall not be bedded (e.g. WC pans and pedestal units) in thick strong mortar that could crack the unit (e.g. a ceramic unit).
- (f) Pipe connections shall be made with de-mountable unions. Pipe work shall not be fixed in a manner that it supports or partially supports an appliance.
- (g) Appliances shall be fixed so that water falls to the outlet (e.g. baths).
- (h) All appliances shall be secured as per the recommendations of manufacturer.
- (i) Appliances shall be fixed true to level firmly fixed to anchor or supports provided by the manufacturer and additional anchors or supports where necessary.

7.2.10 Sizes of Sanitary fixtures given in the Specifications or in the Schedule of Quantities are for identification with reference to the catalogues of makes considered. Dimensions of similar models of other makes may vary within +10% and the same shall be provided and no claim for extra payment shall be entertained nor shall any payment be deducted on this account.

### 7.3 WATER CLOSET

- 7.3.1 WC shall be wash down or siphonic wash down type floor or wall mounted set, as shown in the drawings, designed for low volume flushing from 3-6 litres of water, flushed by means of a flushing cistern or an exposed or concealed type (as detailed in the drawings or as directed by the Engineer) 32 mm size CP brass flush valve with regulator valve. Flush pipe/ bend shall be connected to the WC by means of a suitable rubber adaptor. Wall hung WC shall be supported by CI floor mounted chair, which shall be fixed in a manner as approved by the Engineer.
- 7.3.2 Each WC set shall be provided with a solid plastic seat, rubber buffers and CP brass hinges. Plastic seat shall be so fixed that it remains absolutely stationary in vertical position without falling down on the WC.
- 7.3.3 Each WC set shall be provided with a fixed type CP brass ablution jet, if called for in Schedule of Quantities, complete with CP/ plastic piping, concealed type CP brass angle cock, etc. all of approved make and brand. The nozzle of the ablution jet and its holding down plate shall have smooth and rounded edges and shall not be capable of causing any injury to a user or cleaner.



TCE-10477A-PS-1000 C	<b>TATA CONSULTING ENGINEERS LIMITED</b>	SECTION: WRITE-UP
	<b>WATER SUPPLY, SANITARY &amp; DRIANGAE WORK</b>	SHEET 9 OF 71

#### 7.4 PAN CONNECTOR

- 7.4.1 The WC pan connector shall be Flexible, soft and shall be made of single body construction with integral fins, made from EVA (Ethyl Vinyl Acetate). The pan connector must conform to the BS: 5627: 1984. The pan connector must be supplied with factory fitted spring loaded seal guard.
- 7.4.2 The connector shall not be allowed to come in contact with mineral oil, grease, putty or any compound containing mineral oil or grease.
- 7.4.3 The pan connectors must be stored away from the direct sunlight and flames. While fixing of the pan connector with the Soil pipe, the pipe must be reasonably clean and smooth on the inner surface; in case the soil piping is in C.I. then supplier supplied bush / adaptor shall be used. The connector socket is pushed fully home onto the pan spigot; thereafter the WC is placed in position gently pushing the fitment to ensure that the connector end fits into the Spigot of the pipe. The pan connector must be pushed in such an easy as to ensure that the seals and fins turn inward to ensure proper sealing.

#### 7.5 WASH BASIN

- 7.5.1 Wash basins shall be white glazed vitreous china of size, shape and type specified in the Schedule of Quantities.
- 7.5.2 Each basin shall be provided with painted MS angle or CI brackets and clips and the basin securely fixed to wall. Placing of basins over the brackets without secure fixing shall not be accepted. The MS angle shall be provided with two coats of red oxide primer and two coats of synthetic enamel paint of make, brand and colour as approved by the Engineer.
- 7.5.3 Each basin shall be provided with 32 mm dia. CP waste with overflow, pop-up waste or rubber plug, CP angle valve, CP riser pipe with connectors/ adaptors and CP brass chain as specified in the Schedule of Quantities, 32 mm dia. CP brass bottle trap with CP pipe to wall flange.
- 7.5.4 Wash basin shall be provided with hot and cold water mixing fitting or as specified in the Schedule of Quantities.
- 7.5.5 Basins shall be fixed at proper heights as shown on drawings. If height is not specified, the rim level shall be 790 mm from finished floor level or as directed by the Engineer or architect.

#### 7.6 SINKS

- 7.6.1 Sinks shall be stainless steel or any other material as specified in the Schedule of Quantities.
- 7.6.2 Each sink shall be provided with painted MS or CI brackets and clips and securely fixed. Counter top sinks shall be fixed with suitable painted angle iron brackets or clips as recommended by the manufacturer. Each sink shall be provided with 40 mm dia. CP waste, CP angle valve, CP riser pipe with connectors/ adaptors and rubber plug with CP brass chain as given in the Schedule of Quantities. The MS angle shall be provided with two coats of red oxide primer and two coats of synthetic enamel paint of make, brand and

ISSUE P0
-------------

TCE-10477A-PS-1000 C	<b>TATA CONSULTING ENGINEERS LIMITED</b>	SECTION: WRITE-UP
	<b>WATER SUPPLY, SANITARY &amp; DRIANGAE WORK</b>	SHEET 10 OF 71

colour as approved by the Engineer. Flow Rate = 4.5 to 6 Litres per minute @ 80 PSI

- 7.6.3 Supply fittings for sinks shall be deck mounted CP swivel faucets with or without hot and cold water mixing fittings as specified in the Schedule of Quantities. These shall be measured and paid for separately.

**7.7 MIRRORS**

- 7.7.1 Mirrors shall be electro coated, 6.0 mm thick glass of approved make, plane or beveled edge. The size shall be as specified in the Schedule of Quantities or as shown on the drawings. The image shall be clear and without waviness at all angles of vision.

- 7.7.2 Mirrors shall be provided with backing of 12 mm thick marine plywood, fixed with CP brass semi-round headed screws and cup washers or CP brass clamps as specified or instructed by Engineer.

**7.8 TOILET PAPER HOLDER**

- 7.8.1 Toilet paper holder shall be white glazed vitreous china of size, shape and type specified in the Schedule of Quantities or of stainless steel/ powder coated brass.

- 7.8.2 Porcelain toilet paper holder shall be fixed in walls and set in cement mortar 1:2 (1 cement: 2 coarse sand) and fixed in relation to the tiling work.

- 7.8.3 The latter shall be fixed by means of screws/ capping having finish similar to the toilet paper holder in wall/ timber partitions with rawl plugs or nylon sleeves. When fixed on timber partition, it shall be fixed on a solid wooden base member provided by the Engineer through another agency.

**7.9 LIQUID SOAP DISPENSER**

- 7.9.1 Liquid Soap dispenser shall be wall/ counter mounted suitable for dispensing liquid soaps, lotions, detergents as specified in Schedule of Quantities.

- 7.9.2 Liquid soap dispenser shall be with CP brass bracket, caps, etc. fixed to wall with CP brass screws, and screwed onto wooden rawl plug. The container shall be of CP brass.

**7.10 DRINKING WATER FOUNTAIN**

- 7.10.1 It shall have built-in RO Filtration and UV System.

- 7.10.2 Drinking water fountain shall be wall mounting type made of stainless steel or any other material as given in the Schedule of Quantities.

- 7.10.3 The drinking water fountain shall be with anti-squirt bubble less, self closing valve type with automatic volume regulator.

- 7.10.4 The drinking water fountain shall be provided with an anti-splash back and integral strainer with 32 mm or 40 mm cast brass trap.

**7.11 HAND DRIER**

- 7.11.1 The hand drier shall be no touch operating type with solid state time delay to allow user to keep hand in any position.

ISSUE P0
-------------

TCE-10477A-PS-1000 C	<b>TATA CONSULTING ENGINEERS LIMITED</b>	SECTION: WRITE-UP
	<b>WATER SUPPLY, SANITARY &amp; DRIANGAE WORK</b>	SHEET 11 OF 71

- 7.11.2 The hand drier shall be fully hygienic, rated for continuous repeat use.
- 7.11.3 The rating of hand drier shall be such that time required to dry a pair of hands up to wrists is approximately 30 seconds.
- 7.11.4 The hand drier shall be of wall mounting type suitable for 230 V, single phase, 50 Hz, ac power supply.
- 7.11.5 The material of construction, size and finishing shall be as specified in Schedule of Quantities.

7.12 PILLAR COCK

Pillar cock shall be of CP brass material table mounted type for cold water inlet of approved quality as specified in the Schedule of Quantities. Make & model shall be as per client section. Pillar Cock shall be provided with Suitable Approved type of Angle Cock.

7.13 ROBE HOOK

Robe hook shall be chromium plated brass or of stainless steel or powder coated brass of size, shape and type specified in the Schedule of Quantities.

Robe hook shall be fixed with screws/capping having golden finish in wall/doors with rawl plugs or nylon sleeves and shall include screwing and making good as required or directed by the Engineering Charge.

7.14 PAPER TOWEL DISPENSER

- 7.14.1 Paper towel dispenser shall be wall counter mounted suitable for dispensing paper towels.

7.15 DUST BIN

A waste container is for temporarily storing refuse and waste. Different material is used for different area, usually used material are metal or plastic.

7.16 HEALTH FAUCET

These shall be of CP / sanitary ware. The make and model shall be as specified in Schedule of Quantities. These shall be fixed by means of stainless steel counter sunk screws to wooden! plastic cleats firmly embedded in the wall.

- 15 mm CP health faucet with 1.2m long flexible tube with end nuts & Hook.
- 1 No 15mm CP brass angular stop cock with wall flange
- Hook with CP brass counter sunk screws.

7.17 MEASUREMENT AND RATES

Sanitary fixtures (Porcelain ware and CP fittings) shall be measured by numbers. Rate for providing and fixing of sanitary fixtures, accessories, shall include all items, and operations stated in the respective specifications and Schedule of Quantities and nothing extra is payable. Rates for all items

ISSUE P0
-------------

under specification Clauses above shall be inclusive of cutting holes and chases and making good the same, CP brass screws, nuts, bolts and any other fixing arrangements required and recommended by manufacturers, testing and commissioning etc. complete

#### 7.18 MOCKUP AND TRIAL ASSEMBLY

The installation of the sanitary fixtures and fittings shall be as per the shop drawings approved by the Architect/ Consultant.

The contractor shall have to assemble at least one set of each type of sanitary fixtures and fittings in order to determine precisely the required supply and disposal connections. Relevant instructions from manufacturers shall be followed as applicable. This trial assembly shall be developed to determine the location of puncture holes, holding devices etc. which will be required for final installation of all sanitary fixtures and fittings. The above assembly shall be subject to final approval by the Architect / Interior Designer.

The fixtures in the trial assembly can be re-used for final installation without any additional payments for fixing or dismantling of the fixtures.

#### 7.19 SUPPORTING AND FIXING DEVICES

The contractor shall provide all the necessary supporting and fixing devices to install the sanitary fixtures and fittings securely in position. The fixing devices shall be rigidly anchored into the building structure. The devices shall be rust resistant and shall be so fixed that they do not present an unsightly appearance in the final assembly. Where the location demands, the Architect may instruct the contractor to provide chromium plated or other similarly finished fixing devices. In such circumstances the contractor shall arrange to supply the fixing devices and shall be installed complete with appropriate vibration isolating pads, washers and gaskets.

#### 7.20 FINAL INSTALLATION

The contractor shall install all sanitary fixtures and fittings in their final position in accordance with approved trial assemblies and as shown on drawings. The installation shall be complete with all supply and waste connections. The connection between building and piping system and the sanitary fixtures shall be through proper unions and flanges to facilitate removal/replacement of sanitary fixtures without disturbing the built in piping system. All unions and flanges shall match in appearance with other exposed fittings.

#### 8.0 SOIL, WASTE, VENT & RAIN WATER PIPES

##### 8.1 SCOPE OF WORK

Soil, waste, vent and rain water disposal scope shall include Supply, Installation, testing, commissioning and successful handing over to Owner as per the drawings, specifications and Schedule of Quantities.

All soil, waste and storm water disposal for the portion above ground level to the public sewers/STP shall be by gravity. The soil, waste, vent and rain water pipes system shall inter-alia include the following:

- (a) Vertical and horizontal soil, waste, vent and rainwater pipes and fittings, joints, supports, paints and connections to fixtures.
- (b) Connection of all pipes to sewer lines as shown on the drawings
- (c) Floor and urinal traps clean out plugs, inlet fittings and rainwater (roof) outlets.
- (d) Testing of all pipes and fittings in the workshop.
- (e) Testing, commissioning and handing over of all pipes lines after installation.

## 8.2 GENERAL REQUIREMENTS

- 8.2.1 Pipes and fittings shall be fixed truly vertical, horizontal or in slopes as required in a neat workmanlike manner.
- 8.2.2 Pipes shall be fixed in a manner so as to provide easy accessibility for repair and maintenance and shall not cause obstruction in shafts, passages etc.
- 8.2.3 Pipes shall be securely fixed to walls and ceilings by suitable clamps at intervals specified. Only approved type of anchor fasteners shall be used for fixing pipes on RCC ceilings and RCC/ masonry walls.
- 8.2.4 Access doors for fittings and clean outs shall be so located that they are easily accessible for repair and maintenance.
- 8.2.5 Long bends shall be used on all main pipelines as far as possible. Use of elbows shall be restricted for short connections.
- 8.2.6 Wherever piping is going across the separation/ expansion joints of buildings, piping shall be provided with flexible connectors on both sides of such joints or on single side depending on whether any wall is to be crossed or not.

## 8.3 CAST IRON PIPES & CAST IRON HUBLESS PIPES AND FITTINGS

- 8.3.1 Kitchen waste, fittings and accessories shall be cast iron pipes. All pipes shall be straight and smooth and their inside free from irregular bore, blow holes, crack sand other manufacturing defects. Pipes shall be centrifugally cast (spun) iron soil pipes conforming to IS: 3989 or sand cast to IS: 1729. & C.I Hub less pipe shall confirm IS 210
- 8.3.2 Drip seal PJS-43 shall be used for jointing CI pipes & fittings as per manufacturer's specifications. & Coupling with sealing effected by EPDM rubber gasket is used for jointing purpose

### 8.3.3 Fittings

- (a) Fittings shall conform to the same Indian Standard as for pipes. Contractor shall use pipes and fittings of matching specifications.
- (b) Fittings shall be of the required degree of curvature with or without access door as detailed in the drawings or as directed.
- (c) Access door shall be made up with 3 mm thick insertion rubber washer and white lead. The bolts shall be lubricated with grease or

white lead for easy removal later. The fixing shall be air and water tight.

#### 8.3.4 Fixing

- (a) All vertical pipes shall be fixed by GI clamps truly vertical. Branch pipes shall be connected to the stack at the same angle as that of the fittings. No collars shall be used on vertical stacks. Each stack shall be terminated at top with a cowl (terminal guard).
- (b) Horizontal pipes running along ceiling shall be fixed on structural adjustable clamps of special design shown on the drawings or as directed. Horizontal pipes shall be laid to uniform slope and the clamps adjusted to the proper levels so that the pipes fully rest on them.
- (c) Contractor shall provide all sleeves, openings, hangers, inserts during the construction. He shall provide all necessary information to the building Contractor for making such provisions in the structure as necessary. All damages shall be made good by the Contractor at his own cost to restore the surfaces.
- (d) GI Pipe sleeve one size higher than pipe diameter shall be provided in wall/ floor, wherever pipe crossing wall/ floor. Annular space between pipe and sleeve shall be filled with glass wool and approved sealant as per manufacturer's recommendations.

#### 8.3.5 Clamps

- (a) Holder bat clamps shall be of standard design fabricated from GI flats 40 x 3 mm thick and 10 to 12 mm dia. GI rod and 6 to 10 mm GI nuts and bolts; clamps shall be painted with two coats of synthetic enamel paint over one coat of zinc primer before fixing. The clamps shall be fixed in cement concrete 1:2:4 mix (1 cement : 2 sand : 4 stone aggregate 20 mm nominal size) blocks 100 mm x100 mm x100 mm deep.
- (b) Where holder bat clamps are to be fixed in RCC column or slotted angles, walls or beam they shall be fixed with 40 x 3 mm flat iron "U" type clamps with anchor fasteners of approved design.
- (c) Structural clamps shall be fabricated from GI structural members e.g. rods, angles, channels, flats as per detailed drawing or as directed. Contractor shall provide all nuts, bolts, welding material and paint the clamps with one coat of zinc primer and two or more coats of synthetic enamel paint to give an even shade.
- (d) Slotted angle/ channel supports on walls shall be provided wherever shown on drawings. Angles/ channels/ bolts shall be of sizes shown on drawings or specified in Schedule of Quantities. Angles/ channels shall be fixed to brick walls with bolts embedded in cement concrete blocks of 1:2:4 mix (1 cement : 2 sand : 4 stone aggregate 20 mm nominal size) and to RCC walls with suitable anchor fasteners as directed by the Engineer. The spacing of support bolts horizontally shall not exceed 1 m.
- (e) Wherever GI clamps are required to be anchored directly to brick walls, concrete slabs, beams or columns, nothing extra shall be

payable for clamping arrangement, making PCC blocks and making good with cement concrete 1:2:4 mix (1 cement : 2 sand : 4stone aggregate 20 mm nominal size) as directed by the Engineer-in-Charge.

### 8.3.6 Traps

(a) Cast iron "P" siphon traps:

CI "P" siphon traps shall be cast iron trap of self-cleaning design. The trap and waste pipes shall be set in cement concrete blocks of size 300 mm x 300 mm and of required depth, firmly supported on the structural floor. The blocks shall be in 1:2:4 mix (1 cement : 2 coarse sand : 4 stone aggregate 20 mm nominal size) and extended to 40 mm below finished floor level. Contractor shall provide all necessary shuttering and centering for the blocks at no extra cost.

(b) Urinal traps:

Urinal traps shall be cast iron P or S traps with or without vent and set in cement concrete block.

(c) Floor trap inlet

Floor trap shall be CI floor trap as per IS: 3989 & for C.I Hubless pipe IS 15905. Bath room traps and connections shall ensure free and silent flow of discharging water. Where specified, Contractor shall provide a special type CI/ GI inlet hopper without or with one or two or three inlet sockets to receive the waste pipe. Joint between waste and hopper inlet socket shall be lead caulked. Hopper shall be connected to a CI P or S trap with at least 50 mm seal (hopper and traps shall be paid for separately). Floor trap inlet hoppers and the traps shall be set in cement concrete blocks as specified under clause 8.3.6 above without extra charge.

### 8.3.7 CI Pipe Jointing

Soil, waste, vent, anti-siphon and rain water pipes shall be jointed with drip seal PJS-43. Enough skein of jute rope shall be caulked to leave a minimum space for the drip seal to be applied in.

The following minimum procedures shall be complied with while making the pipe joints:

- (a) Ensure that the pipes are clean internally and not damaged.
- (b) The pipes shall be cut square with sharp tools.
- (c) The cut ends of the pipes shall be filed/ reamed and finished smooth.
- (d) Any deformed ends shall be re-rounded.
- (e) It shall be ensured that the pipe ends shall enter the fittings and sockets to full depth of the jointing area.
- (f) The pipe work shall be assembled in a manner such that it does not entail making of joints in restricted locations.

TCE-10477A-PS-1000 C	<b>TATA CONSULTING ENGINEERS LIMITED</b>	SECTION: WRITE-UP
	<b>WATER SUPPLY, SANITARY &amp; DRIANGAE WORK</b>	SHEET 16 OF 71

(g) Each metal pipe spigot shall be centred with three lightly wedged pieces of hardwood or folded lead.

(h) The jointing surfaces shall be cleaned to remove any coatings or cutting oils, etc.

(i)

#### 8.3.8 C.I Hub less pipe

Pipe are joined by coupling with sealing effected by EPDM rubber gasket is used. A Shield is used to protect the sealing Gasket.

#### 8.4 UPVC & PVC PIPEWORK

UPVC SWR pipe work shall be provided for above ground soil, waste, vent & rain water pipe work as shown in drawings. UPVC SWR pipes & fittings shall confirm to IS: 13592 & IS: 14735 respectively. Pipes shall be of Type - B, pressure rating 6kgs/cm<sup>2</sup>. The pipes shall be supplied in nominal lengths of 2, 3, and 4 or 6 meters, tolerance on specified lengths shall be +10mm and - 0mm. Any physical test requirements shall be as per IS13592-1992.

Soil, waste & vent pipes shall be uPVC pipes & fittings. PVC (SWR) class pipes of diameter 75 mm, 110 mm, 160 mm, 200 mm and 300 mm, of Type/Grade B (conforming to IS:4985 and 6 kg / cm<sup>2</sup>) for use in rain water (unless otherwise specified) and of Type B for soil, waste and ventilation system and conforming to IS 13592: 1992, shall be used. The pipes shall be supplied in nominal lengths of 2, 3, and 4 or 6 meters, tolerance on specified lengths shall be +10mm and - 0mm. Any physical test requirements shall be as per IS 13592-1992.

##### 8.4.1 Handling

Because of their lightweight, there may be a tendency for the UPVC pipes to be thrown often during installation. Reasonable care should be taken in handling and storage to prevent damage to the pipes. The pipes shall be stored as per manufacturer's recommendation. The contractor shall be fully responsible in this case. In no case, pipes should be dragged on the ground. Pipes should be given adequate supports at all times.

##### 8.4.2 Pipe work Installation

UPVC pipes shall be laid under the flooring or hanging below slab or fixed on walls either buried or exposed as the case may be, as shown in the drawings. The minimum thickness of fittings shall be of 3.2 mm. the fittings shall be of injection mould type with solvent cement joint (for exposed piping) or rubber ring joint (for concealed piping). The pipes and fittings shall be capable of withstanding sun's rays. UPVC/PVC pipes laid below slab or suspended from ceiling shall be supported by GI angle brackets / supports as detailed in the drawings.

ISSUE P0
-------------



- a) All vertical pipes shall be fixed by GI or MS clamps truly horizontal. Branch pipes shall be connected to the stack at the same angle as that of the fittings. No collars shall be used on vertical stacks. Each stack shall be terminated at top with a vent cowl (terminal guard).
- b) Horizontal pipes running along ceiling shall be fixed on structural adjustable clamps of special design shown on the drawings or as directed. Horizontal pipes shall be laid to uniform slope and the clamps adjusted to the proper levels so that the pipes fully rest on them.
- c) Contractor shall provide all sleeves, openings, hangers and anchor fasteners during the construction. Sleeves shall be one size higher than pipe or there should be at least 12 mm gap all around between pipes & sleeves. Wherever pipe passes through fire rated wall, the gap shall be filled with fire rated sealant as directed by engineer. For non- fire rated wall, gap shall be filled with wool & silicon sealant (20 mm depth). Contractor shall provide all necessary information to the building work contractor for making such provisions in the structure as necessary. All damages shall be made good by the Contractor at his own cost to restore the surface.
- d) Door type fittings shall be used in vertical piping installations. Door position of fittings shall be on top of fitting. Access door shall be made easily removal. The access door shall be air and water tight. Single - ywe shall be used for horizontal branch connection. Double - ywe fittings shall be used in vertical piping branch connection only.

#### 8.4.3 Jointing

UPVC/PVC pipes & fittings shall be joined as per the manufacturer's instructions /recommendations. UPVC/PVC pipes and fittings shall be joined with Solvent Cement and jointing shall be carried out as follows

- a) Cut the spigot end of the pipe square.
- b) All burrs from the internal and external surfaces should be removed.
- c) The spigot should be marked with a pencil line at a distance equivalent to the socket depth. Clean the surface within the marked area.
- d) Apply uniform coat of approved solvent cement on the external surface to the pipe and a lighter coat on the internal surface of the fitting.
- e) Insert the pipe end into the socket of the fitting and push it in up to the mark.
- f) The pipe work should be assembled in a manner such that it does not entail making of joints in restricted area.

#### 8.4.4 UPVC/PVC Pipe work Testing

- a) UPVC/PVC pipes and fittings assembled shall be tested in accordance with IS 13592 - 1992. The openings of the pipes shall be sealed for the section to be tested. The water column of 2m and shall be maintained for a maximum of 15 minutes. Contractor with their team shall examine carefully all the joints for leakage.
- b) The Contractor shall test all vent pipes by a smoke testing machine. Smoke shall be pumped into the stack after plugging all inlets and connections and filling water in all trap seals. The test shall be conducted under a pressure of 25 mm of water and shall be maintained for 15 minutes. The stack shall then be observed for leakages and all defective pipes and fittings removed or repaired as directed by the Engineer-in-Charge.
- c) A test register shall be maintained, and all entries signed and dated by Contractor and Engineer-in-Charge. Pro-forma of the proposed test register shall be submitted to the Engineer-in-Charge for approval.
- d) All pipes in wall chase or meant to be encased or buried shall be hydro tested before the chase is plastered or the pipe encased or buried.
- e) All systems shall be tested in sections as required to expedite the work for other trades and meet construction schedules and final test on completion.

#### 8.5 WASTE PIPE FROM APPLIANCES

- 8.5.1 Waste pipe from appliances e.g. washbasins, baths, sinks and urinals, etc. shall be of UPVC conforming IS: 4985 as given in the Schedule of Quantities.
- 8.5.2 The internal diameter sizes of outlet branch waste pipes for different fittings shall be as follows:

Wash Basin	40 dia.
Sink	50 dia.
Nahani Trap	75 dia., 50 mm seal.
Multi Floor Trap	75 or 100 dia. as required, with 50 mm or 75 mm seal.
Wash troughs	50 dia.
Canteen wash areas	50 dia.

- 8.5.3 All pipes shall be fixed in gradient towards the outfalls of drains. Pipes inside a toilet room shall be in chase unless otherwise shown on drawings. Where required pipes may be run at ceiling level in suitable gradient and supported

TCE-10477A-PS-1000 C	<b>TATA CONSULTING ENGINEERS LIMITED</b>	SECTION: WRITE-UP
	<b>WATER SUPPLY, SANITARY &amp; DRIANGAE WORK</b>	SHEET 19 OF 71

on structural clamps as directed by the Engineer. Spacing for the clamps shall be 3,000 mm for vertical runs and 2,400 mm for horizontal runs.

- 8.5.4 Pipes shall be UPVC tubes conforming to IS: 4985 and quality certificates shall be furnished. Pipes shall be provided with all required fittings conforming to IS: 4985 e.g. tees, couplings, bends, elbows, unions, reducers, nipples, plugs, etc. All UPVC waste pipes shall be terminated at the point of connection with the appliance with an outlet of suitable diameter. Pipes shall be painted as specified under Clause Error! Reference source not found..
- 8.5.5 The pipes shall be of class 111, 6 Kg/cm<sup>2</sup>. The pipes shall conform to IS 4985- 2000. Fittings shall be of injection moulded PVC conforming to IS 7834 (Part1) - 1975.
- 8.5.6 Pipe sleeves and inserts, etc. through RCC wall of buildings either external or internal or for water tanks shall be of PVC provided with water bar flanged.
- 8.5.7 W.C. pan connectors shall suit the requirements as per drawing, with 40 dia. vent horn for connection to the anti-siphonage pipe. Pan connector shall be of C.I. or lead.
- 8.5.8 Connection to the sewer or storm water collection sumps to be perfectly water tight and as specified in the drawing.
- 8.5.9 Rainwater flashing shall be of 150 100 or 230 150 fitted on to the bell mouth of rainwater pipes inlet and then covered with cast iron grating and extension piece.
- 8.5.10 All rainwater pipes and fittings shall be soil type variety conforming to I.S. 1729-1964 or equivalent. This shall apply to pipe outside buildings within the building or in separate shafts.
- 8.5.11 Bathroom C.P. grating shall be having bolted down design out of heavy cast brass with chromium plating of the best approved standards.
- 8.5.12 Cast iron grating shall be flat with perfect edge and of the best quality procurable of the specified width and thickness and in the available length.

8.6 PIPE LAYING AND FIXING

The pipe laying and jointing shall be done in accordance with IS 7634 (Part 3)- 1975. Pipes shall be cut to size and chamfered well. Burr's if any shall be removed. Pipes and fittings shall be jointed using solvent cement or rubber ring joints. The pipes and fittings shall be jointed accurately without any stress to achieve leak proof joints.

ISSUE P0
-------------

### 8.7 TESTING

The method which is commonly in use is filling the pipe with water, taking care to evacuate any entrapped air and slowly raising the system to the test pressure at 3Kg/cm<sup>2</sup>. The pressure testing may be followed as follows. The field test pressure to be imposed should be not less than the greatest of the following:

- One and half times of maximum sustained operating pressure.
- One and half times the maximum pipe line static pressure.
- Sum of the maximum sustained operating pressure and the maximum surge pressure.
- Sum of the maximum pipe line static pressure and the maximum surge pressure, subject to a maximum equal to the works test pressure for any pipe fittings incorporated.
- The field test pressure should wherever possible be not less than 2/3rd working pressure and should be applied and maintained for at least four hours. If the visual inspection satisfies that there is no leakage the test can be passed.
- A test register shall be maintained and all entries signed and dated by Contractor and Engineer-in-Charge. A Performa of the proposed test register shall be submitted to the Engineer-in-Charge for approval.
- All pipes in wall chase or meant to be encased or buried shall be hydro tested before the chase is plastered or the pipe encased or buried.

### 8.8 CUTING AND MAKING GOOD HOLES / CHASES

Pipes shall be fixed and tested as the building work proceeds. Contractor shall provide all necessary holes, cut outs and chases in structural members as the building work proceeds. Wherever holes are cut or left originally, they shall be made good with cement concrete 1:1:2 (1 cement: 1 coarse sand :2 stone aggregate 20mm nominal size) or cement mortar 1:2 (1 cement :2 coarse sand) as directed by the Engineer-in-Charge and the surface restored as in original condition to the entire satisfaction of the Engineer-in-Charge at no extra cost.

### 8.9 DRAINAGE ACCESSORIES

#### a) Floor Trap

Floor traps grating shall be of stainless steel square / round of size 125 x 125 mm square/round as approved by client & shown in the drawing. Floor trap assembly shall be provided with round stainless steel strainer basket as a cockroach trap. Entire assembly shall be complete with ring, frame, outer cup, inner cup, grating, screws etc. of an approved make.

#### b) Floor Cleanout

Floor cleanout cover shall be of stainless steel square / round of size 125 x 125 mm square / round as approved by client & shown in the drawing. Floor cleanout assembly shall be complete with ring, outer frame, cover, screws etc. of an approved make.

c) Wire Balloons / Grating For Rain Water Pipes

The wire balloons and the domical gratings shall conform to IS: 1729. The wire balloons shall be of galvanized steel. The CI domical gratings for the roof outlet shall be minimum 13mm thick.

Leaf and Gravel grates along with a perforated ring shall be made out of M.S. flat/ bars of a design and dimension as shown in the drawing or as directed by the Engineer-in-Charge. These shall be painted with epoxy paint with a OFT of 200 microns.

Wire balloons/ gratings for rainwater pipes shall be measured by numbers for different sizes. Leaf and gravel grates along with the perforated ring shall be measured in kgs.

d) CI Khurra

The khurras shall be straight type or bend type as per the location of outlet. It consists of a rigid CI body with aluminium dome with SS screw, leaf trap with grating, CI sheet 450mmx450mm welded to collar. The khurra should be fixed firmly on to the parapet wall or roof slab with concrete. Due consideration shall be given to the finished level of roof while fixing the same.

8.10 RAINWATER PIPES

All rainwater pipes shall be of HDPE as shown in drawing & specified in specification.

8.11 HDPE PIPEWORK

HDPE shall be used for above ground rain water pipe work as shown in drawing & specified in specification. HDPE pipes shall conform to 1S 14333 PE 80 grade, pressure rating shall be as indicated in schedule of quantities.

8.11.1 General HDPE Material Requirements

- a) The colour of the pipe shall be black.
- b) High Density Polyethylene (HDPE) material used for the manufacture of pipes shall conform to designation PEEWA-45-T-006 of IS: 7328 - 1992. HDPE conforming to designation PEEWA-45-T-012 of IS: 7328 - 1992 may also be used with the exception that melt flow rate (MFR) shall not exceed 1.10 g/10 min.
- c) When tested from a composite sample of minimum three pipes as per IS: 2530 -1963, at 190° C with nominal load of 5 kgf, Melting Flow Rate shall be

between 0.4 to 1.1 g/10 min (both inclusive) and also shall not differ by more than 20% of the MFR of the material used in manufacturing pipes declared by the manufacturer.

- d) The percentage of anti-oxidant used shall not be more than 0.3 percent by mass of finished resin.
- e) The outside diameter of pipes, tolerance on the same and ovality of pipe shall be as given in the Table below.

Nominal Diameter (DN)	Outside Diameter (mm)	Tolerance (mm)	Ovality (mm)
63	63.0	0.6	1.5
75	75.0	0.7	1.6
90	90.0	0.9	1.8
110	110.0	1.0	2.2
125	125.0	1.2	2.5
140	140.0	1.3	2.8
160	160.0	1.5	3.2
180	180.0	1.7	3.6
200	200.0	1.8	4.0
225	225.0	2.1	4.5
250	250.0	2.3	5.0
280	280.0	2.6	9.8
315	315.0	2.9	11.1
355	355.0	3.2	12.5
400	400.0	3.6	14.0
450	450.0	4.1	15.6
500	500.0	4.5	17.5
560	560.0	5.0	19.6
630	630.0	5.7	22.1

- f) When tested from a composite sample of minimum three pipes, in accordance with IS 2530:1963, the carbon black content shall be within 2.5 (±) 0.5% and the dispersion of carbon black shall be satisfactory.
- g) Tolerance on outside diameter and maximum ovality:  
 The values specified for tolerance on outside diameter have been calculated as 0.009 DN, rounded off to the next higher 0.1 mm, subject to minimum of

TCE-10477A-PS-1000 C	<b>TATA CONSULTING ENGINEERS LIMITED</b>	SECTION: WRITE-UP
	<b>WATER SUPPLY, SANITARY &amp; DRIANGAE WORK</b>	SHEET 23 OF 71

0.3 mm. No negative tolerances are allowed.

- h) The pressure rating of HDPE pipes specials shall be confirming to IS: 14333 or equivalent international standard with temperature and maximum allowable operating pressure criteria as per IS: 14333.
- i) Each straight length of the pipe shall clearly be marked in inedible ink/ paint (inkjet printing) at every one metre with the following information:
  - i) The manufacturer's name and trademark.
  - ii) Designation of the pipe as per the standard specified.
  - iii) Lot number/ Batch number/ year of manufacture.
  - iv) The words "PROJECT NAME".
- j) All HDPE fabricated fittings shall be manufactured from the pipe itself made from same raw material and dimensions as specified above. Fittings shall be strictly fabricated in factory at pipe manufacturing facility. Necessary certificate to be provided by the manufacturer. No fabrication or moulding will be allowed at site, unless specifically permitted by the Engineer.
- k) Manufacturer to provide drawings for HDPE fittings and non-HDPE specials.

#### 8.11.2 HDPE Pipe Work Jointing

Pipes shall be joined using butt fusion joint. Manufacturer's recommendation/ instructions shall be strictly followed during pipe jointing procedure.

#### 8.12 RAIN WATER OUTLET

- a) Rain water out shall be preferably scupper type drain with cast iron body & cast aluminium grating with stainless steel screws. Suitable adopter / connector shall be used to match the pipe. Wherever shafts are not available near rain water outlet, dome type rain water outlet shall be installed.
- b) Rain water outlet shall be tested for water leaking, prior to waterproofing treatment. Extreme care shall be taken, while sealing gap between rain water outlet & wall slab.

#### 8.13 MEASUREMENT AND RATES

Not Used

#### 8.14 CLAMPS

Wherever MS/GI clamps are required to be anchored directly to brick walls, concrete slabs, beams or columns, nothing extra shall be payable for clamping arrangement, RCC block and making good with cement concrete 1:2:4 mix (1 cement:2 sand:4stone aggregate 20mm nominal size) as directed by the Engineer-in-Charge.

ISSUE P0
-------------

#### 8.15 ANGELS / CHANNELS

Slotted angles/ channels shall be measured per linear metre of finished length and shall include support bolts and nuts, length embedded in the cement concrete blocks of 1:2:4 (1cement: 2 coarse sand: 4 stone aggregate 20mm nominal size) formed in the masonry walls; nothing extra shall be paid for the cement concrete block and making good the masonry wall, anchor fasteners etc. complete.

#### 8.16 MANHOLE COVERS

The Cast iron Manhole Cover and Frame shall conform to IS: 1726 and the grade and types have been specified in the Bill of Quantities. The cover and frames shall be cleanly cast and they shall be free from air and sand holes and from cold shuts. They shall be neatly dressed and carefully trimmed. All castings shall be free from voids whether due to shrinkage, gas inclusion or other causes. Covers shall have a raised checkered design on the top surface to provide an adequate non-slip grip.

The sizes of covers specified shall be taken as the clear internal dimensions of the frame. The internal diameter of the manhole is 600mm.

The covers and frames shall be coated with a black bituminous composition. The coating shall be smooth and tenacious. It shall not flow when exposed to a temperature of 63° C and shall not brittle as to chip off at a temperature of 0° C.

#### 8.17 STEPS/FOOT REST/RUNGS

Steps shall be provided wherever the depth of the manhole / chamber is more than 1.2 m. Foot rest shall be C.I. rungs weighing 5.3 kg and conforming to IS 5455-1969 or made up of 20 mm diameter polypropylene foot rest with M.S. reinforcement square or round bars as specified. These shall be embedded 20 cm deep in 20 X 20 X 10 cm blocks of P.C.C. 1:3:6. The blocks with M.S. or C.I. foot rest placed in its centre shall be cast in site along with masonry.

Footrest shall be placed 300 mm apart vertically and 375 mm horizontally in staggered fashion. First footrest shall be 450 mm below top. Footrest shall be painted with bituminous paint and the portion embedded shall be painted with thick cement slurry before fixing.

#### 8.18 INSTALLATION OF SOIL, WASTE & VENT PIPES

All Horizontal pipes running below the slab and along the ceiling shall be fixed on structural adjustable clamps, sturdy hangers of the design as called for in the drawings. The pipes shall be laid in uniform slope and proper levels. All vertical pipes shall be truly vertical fixed by means of stout clamps



in two sections, bolted together, built into the walls, wedged and neatly jointed. The branch pipes shall be connected to the stack at the same angle as that of fittings. All connections between soil, waste and ventilating pipes and branch pipes shall be made by using pipe fittings with inspection doors for cleaning. Pipes shall be fixed in a manner as to provide easy accessibility for repair and maintenance and shall not cause obstruction in shafts. Where the horizontal run off the pipe is long or where the pipes cross over building expansion joints etc. suitable allowance shall be provided for any movements in the pipes by means of expansion joint etc. such that any such movement does not damage the installation in any way.

Before joining, the interior of the socket and exterior of the spigots shall be thoroughly cleaned and dried. The spigot end shall be inserted into the socket right up to the back of the socket and carefully centered by two or three laps of threaded spun yarn, twisted into ropes of uniform thickness, well caulked into the back of the socket. No piece of yarn shall be shorter than the circumference of the pipe. The jointed pipe line shall be at required levels and alignment. The remainder of the socket is left for the lead caulking. Where the gasket has been tightly held, a jointing ring shall be placed round the barrel against the face of the socket. Molten Lead shall be poured to the remainder of the socket.

The joint shall not be covered till the pipe line has been tested under pressure. Rest of pipe line shall be covered so as to prevent the expansion and contraction due to variation in temperature.

#### 8.19 Rainwater Pipes

All open terraces shall be drained by rain water down takes.

Rainwater down takes are separate and independent of the soil and waste system and will discharge to rain water harvesting tank/Catch basin and excess rain water will be diverted to the external storm water drain.

#### 8.20 PREFABRICATED GREASE INTERCEPTORS

- a) The inlet and outlet piping shall have 2-way cleanout tees installed
- b) The inlet piping shall enter the receiving chamber 2 ½" above the invert of the outlet piping.
- c) On the inlet pipe, inside the receiving chamber, a sanitary tee of the same size pipe in the vertical position with the top unplugged shall be provided as a turndown. To provide air circulation and to prevent "air lock", a pipe (nipple) installed in the top tee shall extend 2 inches, but not more than 6 inches, above the interceptor ceiling. A pipe installed in the bottom of the tee shall extend to within 18" of the floor of the interceptor.
- d) The outlet piping shall be no smaller than the inlet piping, but in no case smaller than 4" ID.
- e) The outlet piping shall extend to 12" above the floor of the interceptor and shall be made of a non-collapsible material, preferably schedule 40 PVC pipe.

- f) The outlet piping shall contain a tee installed vertically with a pipe (nipple) installed in the top of the tee to extend 2 inches but not more than 6 inches above the interceptor ceiling.
- g) All pipe penetrations and connections to the interceptor and the sampling box shall be made with resilient connectors. Openings in the sidewall for pipe shall be precast or cored the opening shall be of a size to allow for lateral or vertical adjustments through 20 degrees.
- h) Baffles Grease interceptors designed with an internal baffle as the primary means for the effective and proper operation of the grease interceptor, shall have a non-flexing (i.e. concrete, steel, etc.) baffle the full width of the interceptor, sealed to the walls and the floor, and extend from the floor to within 2" but not more than 6 "from the ceiling. The baffle shall have an opening centered from the sidewalls at least equal in diameter size to the inlet piping, but in no case less than 6" ID. The opening shall be 24 to 30" from the bottom. Slot type openings spanning at least half of the tank width are preferable.
- i) The baffle shall divide the grease interceptor as follows: The influent (inlet) compartment shall be 2/3 of the total liquid capacity with the effluent (outlet) compartment at 1/3 liquid capacity of the interceptor.
- j) Access Openings (Manholes)
- k) Access to grease interceptors shall be provided by a minimum of 1 manhole per interceptor division (baffle chamber) and of 24-inch minimum dimensions terminating 1 inch above finished grade or 2 inches above finished grade when located in natural terrain such as grass or landscape beds with a cast iron frame and cover. One manhole shall be located above the influent (inlet) Tee hatch and the other manhole shall be located above the effluent (outlet) Tee hatch. A minimum of 24" of clear opening above each manhole access shall be maintained to facilitate maintenance, cleaning, pumping, and inspections
- l) Location
- m) Grease Interceptors shall be located so as to be readily accessible for cleaning,
- n) Maintenance and inspections.
- o) Further details shall be shared with Prefab vendor for grease trap.

Grease trap shall be measured by numbers and shall include all items specified above and necessary with all connection & support items for installation, commissioning & fixing.

CI/DI covers, frames and steps shall be included as per schedule of quantities.

## 9.0 DRAINAGE SYSTEM

### 9.1 Scope of work

Without restricting to the generality of the foregoing, the drainage system shall inter-alia include:

- a) Sewer lines including earthwork for excavation, disposal, backfilling and compaction, pipelines, gully traps, grease traps, inspection chambers, manholes, drop connections and connections to the municipal or existing sewer.
- b) Storm water drainage, earth works for excavation, disposal, backfilling and compaction, pipe lines, manholes, catch basins and connections to the existing municipal storm water drain or connected as indicated by the Engineer-in-Charge.
- c) Testing of all pipe lines and the full system after installation.

### 9.2 General Requirements

- a) All materials shall be new and of quality conforming to specifications and subject to the approval of the Engineer-in-Charge. Wherever particular makes are mentioned, the choice of selection shall remain with the Engineer-in-Charge.
- b) Drainage lines and open drains shall be laid to the required gradients and profiles.
- c) All drainage work shall be done in accordance with the Local municipal by-laws. Contractor shall obtain necessary approval and permission for the drainage system from the municipal or any other competent Authority.
- d) Location of all manholes, etc. shall be got confirmed by the Engineer in Charge before the actual execution of work at site.
- e) All materials shall be rust proofed; materials in direct or indirect contact shall be compatible to prevent electrolytic or chemical (bimetallic) corrosion.

### 9.3 S.W. Gully Traps

- a) Stoneware gully traps shall conform to IS 651:1992. These shall be sound, free from visible defects such as fine cracks or hair cracks. The glaze of the trap shall be free from crazing. They shall give a sharp clear note when struck with light hammer. There shall be no broken blisters.
- b) The size of the gully trap shall be specified along with dimension and shall be installed in a chamber as described hereafter.
- c) It shall be fixed on 15 cm. thick and 70 cm square 1:4:8 cement concrete bedding and the gully outlet shall be jointed similarly to the pvc pipes. The corners and bottom of the chamber shall be rounded off so as to slope towards the grating and the bottom of the chamber shall not be less than 230 mm. In addition to 150mm x 150mm CI grating, the chamber shall have a CI frame cover (300mm x 300 mm). It shall then be placed on top of the brick masonry. The frame and sealed cover shall weigh not less than 7.3 kg. Where ever necessary, sealed cover shall be replaced with CI grating of same size.

### 9.4 Gully trap- brick masonry chamber

- a) After fixing and testing gully and branch drain, a brick masonry chamber shall be constructed in second class brick in cement mortar 1:5 (1 cement : 5 fine sand). The chamber shall be built with a 115 mm thick brick work round the

gully trap from the top of the bed concrete up to ground level. The bedding shall be a 700 mm square in 1:4:8 cement concrete. The gully outlet shall be joined to PVC pipes. The space between the chamber walls and the trap shall be filled in with cement concrete 1:5:10 (1 cement: 5 fine sand: 10 graded stone aggregate). The upper portion of the chamber i.e. above the top level of the trap shall be plastered inside with cement mortar 1:3 (1 cement: 3 coarse sand) finished with a floating coat of neat cement, the corners and bottom to the chamber shall be rounded off so as to slope towards the grating and form a hopper.

- b) C.I. cover with frame 300 x 200 mm (inside) shall then be fixed on the top of the brick masonry with cement concrete 1:2:4 (1 cement: 2 coarse: 4 graded stone aggregate 20 mm normal size) and rendered smooth. The finished top of cover shall be left about 4 cm. above the adjoining ground level so as exclude the surface water from entering the gully trap.

## 10.0 WATER SUPPLY SYSTEM

### 10.1 SCOPE OF WORK

The scope shall include supply, installation, testing, commissioning and satisfactory handing over of the complete water supply system to Owner as per drawings, specifications and Schedule of Quantities. The water supply system shall inter-alia include the following:

- a) Distribution system from main supply to all fixtures and appliances for cold and hot water.
- b) Insulation for hot water pipes.
- c) Pipe protection and painting.
- d) Control valves, masonry chambers and other appurtenances.
- e) Connections to all plumbing fixtures, tanks, appliances and municipal mains.
- f) Inserts, nozzles for Reinforced Concrete tanks.

The term water supply is used as indicative of all water supply work required and necessary for the building including such external work as may be necessary to make the system functional.

The scope of this section comprises the supply, installation, testing and commissioning of piping network for water supply for internal services as follows:

- a. Bore well /Municipal /Tanker water supply
- b. Domestic water supply.

The contractor shall make all necessary application and arrangements for his work to be inspected by the Local Authorities.

The contractor shall be solely responsible for obtaining the Authorities approval of his works prior to the handing over of the complete water supply / distribution installation to the owner.

## 10.2 GENERAL REQUIREMENTS

10.2.1 Clause 5.2.1 shall apply.

10.2.2 Clause 5.2.2 shall apply.

10.2.3 Clause 5.2.3 shall apply.

10.2.4 If necessary and if approved by the Engineer, where unavoidable, bends may be formed by means of a hydraulic pipe bending machine for pipes up to 20 mm dia. No bending shall be done for pipes of 25 mm dia. and above. After bending zinc rich paint shall be applied wherever the zinc coating is damaged.

10.2.5 Valves and other appurtenances shall be so located as to provide easy accessibility for operations, maintenance and repairs. Valves shall be located at a height not exceeding 1.6 m above their operating floor/ platform level. Where such a provision is not possible and the valve is to be frequently operated a MS chain shall be provided for its operation.

10.2.6 Clause 6.2.6 shall apply.

## 10.3 GI PIPES, FITTINGS AND VALVES

10.3.1 All pipes inside the buildings and where specified, outside the building shall be M.S. galvanized steel tubes conforming to IS: 1239 of Class specified. When Class is not specified they shall be Heavy Class. All embedded / concealed pipes shall be of heavy duty.

10.3.2 Fittings shall be of malleable cast iron galvanized, of approved make. Each fitting shall have manufacturer's trade mark stamped on it. Fittings for GI pipes shall include couplings, bends, tees, reducers, nipples, unions, bushes etc. Fittings etc. shall conform to IS: 1879.

10.3.3 Pipes and fittings shall be jointed with screwed joints using Teflon tape suitable for water pipes. Care shall be taken to remove burr from the end of the pipe after cutting by a round file. All pipes shall be fixed in accordance with layout and alignment shown on the drawings. Care shall be taken to avoid air pockets. Necessary vents and drains shall be provided at all high and low points respectively. GI pipes inside toilets shall be fixed in wall chases well above the floor. No pipes shall be run inside a sunken floor as far as possible. Pipes may be run under the ceiling or floors and other areas as shown on drawings. All pipe joints after testing of the line shall be seal welded and the weld plus the adjoining portion shall be given two coats of zinc rich primer.

10.3.4 Bib cocks and stop cocks

All bib cocks and stop cocks shall be of C.P. brass conforming to IS: 781 of tested quality and approved make and design, of diameter as specified in schedule of quantities.

#### 10.3.5 Clamps

GI pipes in shafts and other locations shall be supported by GI clamps of design approved by the Engineer-in-Charge. Pipes in wall chases shall be anchored by iron hooks. Pipes at ceiling level shall be supported on structural clamps fabricated from MS structural's as described in Clause 6.3.5. Pipes in shafts shall be supported on slotted angles/ channels as specified/ as directed.

#### 10.3.6 Unions

Contractor shall provide adequate number of unions on all pipes to enable easy dismantling later when required. Unions shall be provided near each gunmetal valve, stop cock or check valve and on straight runs as necessary at appropriate locations as required for easy dismantling and/ or as directed by the Engineer-in-Charge.

#### 10.3.7 Flanges

Flanged connections shall be provided on pipes as required for maintenance/ ease in dismantling or where shown on the drawings, all equipment connections as necessary and required or as directed by the Engineer-in-Charge. Connections shall be made by the correct number and size of the GI nuts/ bolts as per relevant IS Standards and made with 3mm thick insertion rubber washer/gasket. Where hot water or steam connections are made insertion gasket shall be of suitable high temperature grade and quality approved by the Engineer-in-Charge. Bolt hole dia for flanges shall conform to match the specification for CI sluice valve as per IS: 780. Gaskets shall conform to IS: 11149.

#### 10.4 CPVC (CHLORINATED POLY VINYL CHLORIDE) PIPES & FITTINGS

CPVC pipes & fittings solvent welded type shall be used for internal cold & hot water supply piping work. CPVC pipes from 15mm to 50 mm shall be Class - 1, SDR-11 conform to the requirements of IS 15778. CPVC pipes from 65mm to 300 mm shall be schedule 40 / schedule 80 class conform to the requirements of ASTM-F441 & as described in the BOQ/SOQ.

Coefficient of thermal expansion- ASTM D - 696- $6.3 \times 10^{-5}$  m/m0K Thermal conductivity – ASTM C 177 – 0.14 Wm/0K/m<sup>2</sup>

CPVC fittings i.e. sockets, tees, bends, reducers, brass threaded male/female connectors, brass threaded male/female adapters unions, bushings etc shall comply to the requirements of ASTM F438 & ASTM F439

for schedule 40 & schedule 80 class respectively. Solvent cement for CPVC pipe shall comply as per ASTM F493.

CPVC pipe work shall be installed strictly as per the recommendation of manufacturer. CPVC pipe work shall be adequately supported by GI split clamps with GI structural supports & GI threaded rods. CPVC pipe work shall be securely tight with GI nuts, bolts & washers. Pipe work spacing shall be as per guidance of manufacturers.

After completion of piping work, piping shall be hydraulically tested in parts with test pumps at 10bar for 24 Hrs or 1.5 times working pressure, whichever is higher. CPVC test plugs shall be used to seal the dead end of piping. Upon completion of entire installations, the complete system shall be tested as described above.

Upon successful testing of entire piping system, it shall be painted with one coat of approved primer & two coats of approved synthetic enamel paint, as per direction of engineer-in-charge / client.

#### 10.4.1 CPVC Piping Installation Procedure

- a) Pipe shall be cut truly straight to the required length
- b) Remove burr (shaving) & clean the cut portion with dry cloth. Ensure that jointing portion is free from any dirt, grease or any other foreign material.
- c) Install dry fit out, by inserting pipe inside the sockets up to 1/3rd to 2/3rd penetration depths. Ensure that pipe inserts to the bottom of the sockets, without any resistance. If pipe inserts is not to the sockets, then check with another fittings.
- d) Apply a thin coat of solvent cement to the inner side of socket up to its bottom & full coat to the outer side of pipe.
- e) Insert pipe in to the socket, till the solvent is in fluid state. Twist the pipe turn to cover any dry spots.
- f) Hold the pipe for at least 30 seconds, to ensure proper jointing. Wipe out excess solvent cement with clean dry cloth.
- g) Allow joint to cure for at least 24 Hours.
- h) For pipe greater than 50 mm diameter, pipe work shall be jointed with primer & heavy duty solvent cement.
- i) Teflon tape shall be used for threaded portion of fittings.
- j) Manufacturer's recommendation shall be followed during pipe work installations.

#### Rating & Dimensional Details of CPVC Pipes SDR 11

Diameter & Wall thickness of CPVC pipes SDR – 11 are as per Table given below: -

S.N	Nominal pipe size (mm)	Mean outside diameter			Wall Thickness		
		Min	Max	Mean	Min	Max	Avg Max
1	15	15.8	16	15.9	1.7	2.2	2.2
2	20	22.1	22.3	22.2	2	2.5	2.5
3	25	28.5	28.7	28.6	2.6	3.1	3.1
4	32	34.8	35	34.9	3.2	3.7	3.7
5	40	41.2	41.4	41.3	3.8	4.3	4.3
6	50	53.9	54.1	54	4.9	5.5	5.5

Note: For CPVC Pipes SDR is calculated by dividing the average outer diameter of the pipe in mm by the minimum wall thickness in mm. If the wall thickness calculated by this formula is less than 1.52 m. The SDR values shall be rounded to the nearest 0.5

Pressure rating @230C – 27.6 Kg/cm<sup>2</sup>

Pressure rating @820C – 7.03 Kg/cm<sup>2</sup>

(FOR PIPE DIAMETER ABOVE 50MM Sch.40)

Nominal pipe size		Outer Dia.	Inner Dia.	Wall Thickness	Pressure rating
(Inch)	(mm)	(mm)	(mm)	(mm)	(Kg/cm <sup>2</sup> )
2 1/2"	65	73.3	62.1	5.16	21.10
3"	80	88.9	77.27	5.49	18.28
4"	100	114.3	101.5	6.02	15.47
6"	150	168.28	153.19	7.11	12.66

Pipes shall be painted with bituminous paint and covered with polythene tape and a final coat of bitumen paint. Exposed pipes shall be painted with two or more coats of Synthetic enamel paint. The portion embedded shall be painted with thick cement slurry before fixing. Colour to be verified as per IS standards for all the pipes.

#### 10.4.2 Supports Spacing

CPVC pipe work supports shall be provided as per below table.



Nominal Size	Pipe size	Supports spacing (Meter) respectively with pipe size			
		23 OC	38 OC	60 OC	80 OC
15 mm	SDR 11/ SDR 13.5	1.22 / 1.22	1.22/ 1.22	1.07/ 1.07	0.92/ 0.92
20 mm	SDR 11/ SDR 13.6	1.53 / 1.53	1.37/ 1.37	1.22/ 1.22	0.92/ 0.93
25 mm	SDR 11/ SDR 13.7	1.68/ 1.68	1.53/ 1.53	1.37/ 1.37	0.92/ 0.94
32 mm	SDR 11/ SDR 13.8	1.83/ 1.83	1.68/ 1.68	1.53/ 1.53	1.22/ 0.92
40 mm	SDR 11/ SDR 13.9	1.98/ 1.98	1.83/ 1.83	1.68/ 1.68	1.22/ 0.93
50 mm	SDR 11/ SDR 13.10	2.29/ 2.29	2.14/ 2.14	1.98/ 1.98	1.22/ 0.94
65 mm	SCH 40 / SCH 80	2.13/ 2.86	2.13/ 2.86	1.82/ 1.98	1.06/ 1.22
80 mm	SCH 40 / SCH 81	2.13/ 2.59	2.13/ 2.59	1.82/ 2.13	1.06/ 1.22
100 mm	SCH 40 / SCH 82	2.86/ 2.74	2.86/ 2.74	1.98/ 2.86	1.22/ 1.37
150 mm	SCH 40 / SCH 83	2.59/ 3.04	2.59/ 2.89	2.13/ 2.59	1.37/ 1.52

### 10.5 POLYPROPYLENE RANDOM CO-POLYMER (PP-R) PIPES

The PP-R is a bonded, multilayer pipe consisting of different layers of the pipe:-

- The inner-most layer of the pipe to be Anti – bacterial to prevent bacteria growth inside pipe surface.
- The middle layer to be of plain PP-R which is neither in contact with Water and nor under direct effect of the atmospheric conditions.
- The outer-most layer to be of U.V. stabilized PP-R to prevent the pipe surface from sunlight under exposed atmospheric conditions.

The pipes should in general be conforming to the requirements of IS 15801 except that specified with in nomenclature of the item. The pipes should have smooth inner surface with non-contracting diameters. The pipes shall be cleanly finished, free from cracks and other defects.

The pipes shall be clean and well cut along ends after taking into consideration the desired length, using the pipe scissors. The Polypropylene used for manufacturing the pipe shall conform to the requirements of IS 10951 and IS 10910. The specified base density shall be between 900 kg/m<sup>3</sup> and 910 kg/m<sup>3</sup> when determined at 27°C. The resin should be mixed with sufficient quantity of colour master batches. The colour master batch should be uniform throughout the pipe surface. The standard dimension ratio (SDR) i.e. ratio of the nominal outer diameter of a pipe to its nominal wall thickness should be 7.4/11 as given in the item.

#### 10.5.1 Fittings

Plain fittings, Chrome plated brass threaded fittings and Valves shall be as per nomenclature of item or as directed by engineer- in- charge.

- a) The plain fittings shall be Polypropylene Random Copolymer and comply with all the requirements of the pipes. The plain fittings shall comprise of Socket, Elbow, Tee, Cross, Reducer socket, Reduction Tee, End Cap, Crossover, Omega, Threaded Plug and wall clamps in available sizes.
- b) The Chrome Plated Brass threaded fittings shall be Chrome Plated Brass threaded piece moulded inside Polypropylene random copolymer fitting. The material shall comply with all the requirements of the pipes. The Chrome plated Brass threaded fittings shall comprise of Socket, Elbow and Tee (Male & Female) in available sizes. These are the fittings for C.P. connections and for continuations from existing Galvanized Iron Pipes and fittings.
- c) The valves shall be Polypropylene Random Copolymer Valves. The valves comprise of Gate Valve, Ball Valve, Concealed stop valve and Chrome Coated Valve in available sizes.
- d) The Valves sizes availability in Polypropylene Random Copolymer is as follows: -
- (i) Gate Valve - 20 mm to 63 mm
  - (ii) Ball Valve - 20 mm, 25 mm, 32 mm, 40 mm, 50 mm & 63 mm
  - (iii) Concealed Stop valve - 20 mm & 25 mm
  - (iv) Chrome Coated Valve - 20 mm & 25 mm

However, the other Brass/Bronze Valves can be connected to Polypropylene Random pipes using C.P. Brass threaded fittings of desired sizes.

#### 10.5.2 Laying and Jointing of Pipes and Fittings

The pipes and fittings shall run in wall chase as specified. Pipes shall run only in vertical or horizontal alignment as far as possible. The installation of pipes is similar to that of the metal pipes with the only difference in the jointing procedure. The jointing of the PP-R pipes and fittings are done by fusion welding by means of a welding machine.

The marking on pipe shall carry the following information:-

- a) Manufacturer's name/ trade mark
- b) PPR pipe
- c) SDR
- d) Outside diameter and minimum wall thickness
- e) Lot No. / Batch No. containing date of manufacturing. And machine number.

The outside diameter of pipes, tolerance in the same and ovality of pipe shall be as given in Table below.

Sl.No.	Nominal Size	Outside Dia	Tolerance (Only positive tolerance)	Ovality
	DN	mm	mm	mm
i	16	16.0	0.3	1.2
ii	20	20.0	0.3	1.2
iii	25	25.0	0.3	1.2
iv	32	32.0	0.3	1.3
v	40	40.0	0.4	1.4
vi	50	50.0	0.5	1.4
vii	63	63.0	0.6	1.6
viii	75	75.0	0.7	1.6
ix	90	90.0	0.9	1.8
x	100	110.0	0.9	2.2

- a) The values specified for tolerance on outside diameter have been calculated as  $0.009DN$ , rounded off to the next higher 0.1 mm subject to minimum of 0.3 mm. No negative tolerances are allowed.
- b) The basis for the values specified for ovality is:
- i) For nominal outside diameters  $\leq 75$  mm, the tolerance equals  $(0.008 DN + 1.0)$  mm, rounded to the next higher 0.1 mm, with a minimum value of 1.2 mm.
  - ii) For nominal outside diameters  $\geq 75$  mm and  $\leq 250$  mm, the tolerance equals  $0.20 DN$ , rounded to the next higher 0.1 mm.
  - c) For nominal outside diameter  $> 250$  mm, the tolerance equals  $0.35 DN$ , rounded to the next higher 0.1 mm.

### 10.5.3 Wall Thickness

The minimum and maximum wall thickness of pipes shall be as given in Table below:-

Note: The wall thickness tolerances have been calculated on the following basis:

- (a) Limit deviation =  $0.1e + 0.2$  mm rounded up to the nearest 0.1 mm.
- (b) A local increase in wall thickness of up to  $+0.2e$  is permissible for  $e$  up to 10 mm and up to  $0.15e$  for  $e$  greater than 10 mm. The mean of the measurement shall, however, still lie within the given limit deviations.

Sl.no	Nominal size	SDR11		SDR 7.4	
		Min	Max	Min	Max
i	16	-	-	2.2	2.7
ii	20	1.9	2.3	2.8	3.3
iii	25	2.3	2.8	3.5	4.1
iv	32	2.9	3.4	4.4	5.1
v	40	3.7	4.3	5.5	6.3
vi	50	4.6	5.3	6.9	7.8
vii	63	5.8	6.3	8.6	9.7

viii	75	6.8	7.7	10.3	11.6
ix	90	8.2	9.3	12.3	13.8
x	110	10	11.2	15.1	16.9

The quality of each installation system ultimately depends on the tightness, stability and lifetime of its connections. The pipe of the desired length is cut using the pipe scissors. The proper heating piece is taken and mounted on the welding machine. The welding device is switched on - Control lamp and switch lamp will lit. When ready, control lamp gets off, which means that welding temperature of 260 Degrees  $\pm 10$  Degrees Celsius has been reached. The pipe end and the fitting to be welded are heated on the welding machine. Before heating the fitting and the pipe, the dirty welding tools, pipe and fitting are cleaned with a cloth. When heated up (with heating time as per the Table shown below), the pipe CPWD SPECIFICATIONS 2009 824 and the fitting is removed from the welding machine and the two pieces connected by applying a little pressure without twisting. The joint can cool down for a few seconds. The welding process is that safe because the properly heated part of Polypropylene creates a homogeneous connection.

Guidelines for Welding PP-R Pipes and Fittings (DVS Guideline 2207, Part II)

Diameter of pipe(mm)	Heating Time (Seconds)	Cooling Period (Minutes)
16	5	2
20	5	2
25	7	2
32	8	4
40	12	4
50	18	4
63	24	6
75	30	8
93	30	8

The same procedure shall be adapted for exposed as well as concealed fittings. The Crossovers may be used wherever the overlapping of the PP-R pipes is required. The fixing shall be done by means of Wall Support Clamps keeping the pipes about 1.5 cm clears of the wall where to be laid on the surface. Where it is specified to conceal the pipes, chasing may be adopted. For pipes fixed in the shafts, ducts

Etc. there should be enough space to work on the pipes with the usual tools. Pipe sleeves shall be fixed at a place the pipe is passing, through a wall or floor for reception of the pipe and allow freedom for expansion and contraction and other movements. Fixed supports prevent any movement of the pipe by fixing it at some points. Fittings are used in creating the fixed points. Fixed supports must not but

Installed at bending parts and the direction changes must be done in the pipe itself. In between the fixed supports some arrangements must be done to compensate any potential elongation or shrinkage in the pipe length. For

exposed straight pipes having length more than 5 meters, to compensate the expansion an expansion piece must be used.

#### 10.5.4 Piping Installation Support

Piping shall be properly supported by means of wall support clamps as specified and as required, keeping in view the proper designing for expansion and contraction. Risers shall be supported at each floor with clamps. Due to high coefficient of thermal expansion the heat losses though the pipes is highly reduced. Therefore, for internal Bathroom hot geyser water distribution lines, the insulation is often not required

#### 10.5.5 Anchor Blocks

Suitable anchor blocks shall be provided at all bends and tees to encounter the excessive thrust developed due to water hammer

#### 10.5.6 Rubber Joints

Joints between two pipes shall be made by pre-moulded rubber joints with suitable tackles in a manner recommended & approved by the manufacturer. No joints shall be covered until the lines are hydraulically tested.

#### 10.5.7 Thrust Blocks

In case of bigger pipes (80 mm diameter and above), thrust blocks of cement concrete 1:2:4 (1 cement: 2 coarse sand: 4 graded stone aggregate of 20 mm nominal size) shall be constructed on all bends as directed by the Owner's site representative.

### 10.6 VALVES & FITTINGS

All valves (gate, globe, check, safety) shall be of gun metal suitable for the service as specified. All valves shall be of the duty and design as specified. Valves shall either be of screwed type or flanged type, as specified, with suitable flanges and non-corrosive bolts and gaskets. Tail pieces as required shall be supplied along with valves. Gate, globe and check valves shall conform to Indian Standard IS: 776 and non-return valves and swing check type reflux to IS: 5312.

Sluice valves, where specified shall be flanged sluice valves of cast iron body. The spindle, valve seat and wedge nuts shall be gunmetal. They shall generally have non-rising spindle and shall be of the duty and design as specified. The valves shall be supplied with suitable flanges, non-corrosive bolts and asbestos fibre gaskets. Sluice valves shall conform to Indian standard IS: 780 and IS: 2906.

Ball valves with floats to be fixed in storage tanks shall consist of cast brass lever arm having copper balls (26 SWG) screwed to the arm integrally. The copper ball shall have bronze welded seams. The closing/opening mechanism incorporating the piston and cylinder shall be non-corrosive metal and include washers. The size and construction of ball valves and float shall be suitable for desired working pressure operating the supply system.

Where called for forged brass valves shall be supplied with brass hexagonal back nuts to secure them to the tanks and a socket to connect to supply pipe.

Sl.no	Type of Valve	Size	Construction	Ends
a.	Isolating Valve.	15 mm to 50 mm 65 mm and above	Gun Metal	Screwed Flanged
b.	Sluice Valve & Butterfly Valve	65 mm and above	Cast Iron	Flanged
c.	GM non return valve	15 mm to 50 mm 65 mm above	Gun Metal	Screwed Flanged
d.	Flap Type – Non return valve	65 mm and above	Cast Iron	Flanged

#### 10.7 Gunmetal Valves

Valves 65 mm dia. and below shall be heavy gunmetal full way valves or globe valves conforming to Class I of IS: 778. Valves shall be tested at manufacturer's works and the same stamped on it.

All valves shall be approved by the Engineer-in-Charge before they are allowed to be used in the Work.

#### 10.8 Sluice Valves

Unless otherwise specified all valves 80 mm dia. and above shall be CI double flanged sluice valves with non rising spindle. Sluice valves shall be provided with wheel when they are in exposed positions and with a cap top when they are located underground. Contractor shall provide suitable operating keys for sluice valves with cap tops.

Sluice valves shall be of approved makes conforming to IS: 780 of Class as specified.

#### 10.9 Butterfly Valves

Where specified, Valves 80 mm dia. and above shall be cast iron butterfly valve to be used for isolation and/ or flow regulation as directed by the Engineer. The valves shall be tight shutoff/ regulatory type with resilient seat suitable for flow in either direction and seal in both directions.

Butterfly valve shall conform to IS: 13095.

#### 10.10 Non-Return Valve

Where specified non return valve (swing check type) shall be provided through which flow can occur in one direction only. It shall be single door swing check type of best quality conforming to IS: 5312.

#### 10.11 Forged Brass Ball Valve

Valves of size 50 mm dia. and below shall be full bore quarter turn lever operated female threaded forged brass hard chrome plated ball valves

conforming to IS: 554. Valve shall have PTFE body seat rings and gland packing, forged brass ball, stem and bonnet, carbon steel nut washer and lever and finished in chrome. Valves shall have minimum working pressure of 20 bar. Valves shall be tested at manufacturer's works and the same stamped on it.

#### 10.12 Ball Type Non-Return Valve (NRV)

Ball type NRV shall be used in water treatment plants and sewage sump pump piping. NRV shall be constructed in cast iron body with epoxy coating, phenolic resin and NBR (Nitrile) seal. NRV shall have flanged ends and can be installed in horizontal as well as vertical position. NRV shall have minimum working pressure of 20 bar or as per system requirements. Valves shall be tested at manufacturer's works and the same stamped on it.

#### 10.13 Air Release Valve (ARV)

Pressurized water supply lines shall be provided with air release valve at highest point to release accumulated air for piping system. Air release valve shall be automatic float operated, the diameter shall be as specified in the Schedule of Quantities. Air release valve shall be provided with ball valve for ease in Operation and Maintenance. Valve body shall be in cast iron stainless steel, brass and EPDM internal components. Valves shall have minimum working pressure of 20Kgs.

Air release valve shall be installed as per specifications provided in BOQ.

##### Table Commonly Adopted Size of Air Valves

Air release valves shall be single acting type air valves with cast iron body and bronze/gunmetal internal parts and plastic float.

Each air release valve shall be provided with a cast iron isolating sluice valve of specification given above.

#### 10.14 PRESSURE RELIEF VALVES

Each pressure relief valve shall be of the fully enclosed type and fitted with hand easing gear.

Each pressure relief valve in a pressure reducing station shall have a flow capacity equal to that of the pressure reducing valve. PRV shall be of Brass.

Pressure relief valves in locations other than reducing stations shall have flow capacities equal to that of the associated equipment.

#### 10.15 NON RETURN VALVE

Where specified non return valve (swing check type) shall be provided through which flow can occur in one direction only. It shall be single door swing check type of best quality conforming to IS: 5312.

#### 10.16 PRESSURE GAUGE

The pressure gauge shall be constructed of die cast aluminium and stove enameled. It shall be weather proof with an IP 55 enclosure. It shall be a stainless steel Bourdon tube type pressure gauge with a scale range from 0 to 16 Kg / cm square, 6" dial and shall be constructed as per IS:3524. Each pressure gauge shall have a siphon tube connection. The shut off arrangement shall be by Ball Valve.

Calibration certificate shall be obtained and submitted for each pressure gauge, flow meter, pH transmitter, conductivity meter, HP & LP Switch, Diff. pressure switch, level transmitter density meter, etc.

#### 10.17 BALL VALVES

Ball Valves have body material as Forged Brass Chrome plated with Spindle Brass Nickel Plating & Lever handle Steel Chrome plated with green plastic cover. The valve is suitable for water maximum working pressure up to 25 bar (PN 25). The valve is operated by turning. The rotation from open to close is a quarter turn (90 degree) which closes in a clock-wise direction.

#### 10.18 BUTTERFLY VALVES

The butterfly valve shall be suitable for waterworks and rated Pressure requirement as mentioned in the Schedule of quantities.

The body shall be of cast iron to IS: 210 in circular shape and of high strength to take the water pressure. The disc shall be heavy duty cast iron with anti- corrosive epoxy or nickel coating.

The valve seat shall be of high grade elastomeric or nitrile rubber. The valve in closed position shall have complete contact between the seat and the disc throughout the perimeter. The elastomeric rubber shall have a long life and shall not give away on continuous applied water pressure.

The valve shall be fitted between two flanges on either side of pipe flanges. The valve edge rubber shall be projected outside such that they are wedged within the pipe flanges to prevent leakages.

Butterfly valves of approved quality for pressure rating of 230 P.S.I. with locking arrangement and gearbox with handle operated or gearbox with lid shall be provided or as given in the Bill of Quantities.

Butterfly valves shall be of specified quality conforming to IS: 13095 or BS:5155.



Joints for butterfly valves shall be made with suitable tail /socket pieces on the pipe line and flanged joints made with 3mm thick insertion rubber gasket with appropriate number of bolts, nuts and washers.

#### 10.19 Solenoid Valve

The high pressure solenoid valve is a two-way type with one inlet and one outlet. It is a pack less, internal pilot operated valve, suitable for use in releasing water pressure from the priming chamber of Deluge Valves and Flow Control Valves. The solenoid valve has floating diaphragm construction, which requires a minimum pressure drop across the valve to operate properly. The valves are available with a voltage rating of 24V DC in a normally closed or normally open configuration. These solenoid valves are for use with system control units that are listed and/or approved for releasing service for water based fire protection systems.

#### 10.20 Level Sensors

Level sensor shall consist of control unit, preamplifier and one full insulated probe-mounted vertically or two part insulated probe mounted from tanks side wall adjustable switching system for pump control application, the same to be housed in stove enamel painted cast aluminium weather proof suitable for black panel / wall mounting etc.,

The enclosure of probes shall be manufactured with SS316 material. The least count of the central unit with amplifier should be +/- 0.10mm for response value of 30 seconds.

#### 10.21 Level Indicators

A level control system with electronic level probes is mounted on the face of the reservoir. The top two level sensors provide the ON-OFF signal for the treated water transfer pumps. A third level sensor enunciates a low level alarm condition to the paging system and a fourth sensor enunciates an alarm to the paging system and stops the domestic water pumps from operating.

#### 10.22 Pressure Gauge

Pressure gauge shall be provided as shown in drawings. Pressure gauge shall be 50 mm dia gunmetal bourdon type with gunmetal isolation ball valve, tapping and connecting pipe and nipple. The gauge shall be installed at appropriate height for easy readability. All gauges in the main fire pump room and ICV stations shall be glycerin filled gauges.

Pressure gauges fitted in the installations shall comply with IS 4224. The scale subdivision shall not exceed

0.2 bar for a maximum scale value up to and including 20 bar

0.5 bar for a maximum scale value of more than 20 bar

1.0 bar for a maximum scale value more than 20 bar.

#### 10.23 LEVEL SWITCH

Level switches shall be provided as shown in drawing which is of electro-magnetic type. Level switches shall control/sense liquid in open or pressurized.

#### 10.24 WATER METERS

Water meters of approved make and design shall be supplied for installation at locations as shown. The water meters shall meet with the approval of local supply authorities. Suitable valves and chambers or wall meter box to house the meters shall also be provided along with the meters.

The meters shall conform to Indian Standard IS: 779 and IS: 2373. Calibration certificate shall be obtained and submitted for each water meter.

Provision shall also be made to lock the water meter. The provision shall be such that the lock is conveniently operated from the top. Where the provision is designed for use in conjunction with padlocks, the hole provided for padlocks shall be a diameter not less than 4mm.

(Note: The water meters to be installed and at every use of water such as Landscape irrigation, Domestic, Firefighting etc.)

#### 10.25 INSTALLATION OF WATER METERS AND STOP COCK

Lines shall be cut to the required lengths at the position where the meter and stop cock are required to be fixed. Suitable fittings shall be attached to the pipes. The meter and stop cock shall be fixed in a position by means of connecting pipes, jam nut and socket etc. The stop cock shall be fixed near the inlet of the water meter. The paper disc inserted in the ripples of the meter shall be removed. And the meter installed exactly horizontal or vertical in the flow line in the direction shown by the arrow cast on the body of the meter. Care shall be taken that the factory seal of the meter is not disturbed. Wherever the meter shall be fixed to a newly fitted pipe line, the pipe line shall have to be completely washed before fitting the meter.

#### 10.26 TESTING

All pipes, fittings and valves shall be tested in accordance with IS: 2065 except as may be modified herein under. All pipes, fittings and valves, after fixing at site, shall be tested to a hydrostatic pressure of 10 kg/cm<sup>2</sup> or 1.5 times the shut off head of the pump whichever is greater.

The test pressure shall be maintained for a period of at least thirty minutes without any drop-in pressure.

A test register shall be maintained, and all entries shall be signed and dated by Contractor(s) and the Engineer.

**10.27 UNDERGROUND / OVERHEAD STORAGE TANKS**

- a) Storage tanks for water supply shall be in RCC.
- b) Each tank shall be provided with lockable type manhole cover fabricated from MS sheet or standard cast iron tank covers. Manhole covers shall be of appropriate size as directed by the Engineer-in-Charge.
- c) Each storage tank shall be provided with high and low level annunciation by means of magnetic level switches. One solid state electronic annunciation panel fully wired with visual display and audible alarm unit shall be provided to indicate the following:
  - High and low level alarms for each water storage tank.
  - On/ off status of all Pump sets namely domestic
- d) All the necessary arrangements for fixing the panel shall be provided by the Contractor.
- e) All the cabling from the respective level switches to the Annunciation Panel, MCC Switch gear to Annunciation Panel, including power supply from MCC shall be provided by the Contractor.
- f) The number of outgoing terminals shall be equal to the number of incoming terminals from field/ MCC with 20% margin, so that necessary interconnection to BMS could be done at a later date.

**10.28 TESTING**

- (a) All pipes, fittings and valves shall be tested in accordance with IS: 2065 except as may be modified herein under. All pipes, fittings and valves, after fixing at site, shall be tested to a hydrostatic pressure of 20 kg/cm<sup>2</sup> or 1.5 times the shut off head of the pump whichever is greater.
- (b) The test pressure shall be maintained for a period of at least thirty minutes without any drop in pressure.
- (c) A test register shall be maintained and all entries shall be signed and dated by Contractor(s) and the Engineer-in-Charge.
- (d) After commissioning of the water supply system, the Contractor shall test each valve by closing and opening it a number of times to observe if it is working efficiently and effectively. Valves which do not operate efficiently and effectively shall be replaced by new ones at no extra cost and the same shall be tested as above.
- (e) All pipes in wall chase or meant to be encased or buried shall be hydro tested before the chase is plastered or the pipe encased or buried.

**10.29 INSULATION**

All open hot water flow and return pipes shall be insulated with preformed fibrous pipe sections conforming to IS: 9842.

Insulation to pipes shall be with pre-moulded pipe sections, thickness for sections shall be:

- a) Pipe 50mm diameter and below - 25mm thick
- b) Pipe 65mm diameter and above - 40mm thick

Application:

- a) All surfaces shall be thoroughly cleaned with a wire brush.
- b) One layer of approved primer shall be applied and pre-moulded pipe insulation sections shall be fixed.
- c) One layer of aluminum foil of thickness 0.711mm (20 SWG), shall be applied as a finish layer.

Insulation for hot water pipes in chase:

All hot water pipes in chase shall be insulated with 3 mm elastomeric tape as per manufacturer's recommendations.

### 10.30 DISINFECTION OF INSTALLATION

The water supply installation shall be disinfected as per standards and as follows:

- a) Tanks and pipes shall be filled and flushed out.
- b) All bib cocks (taps) shall be closed.
- c) Tanks and pipes shall be re-filled while adding sterilizing admixture containing 50 parts chlorine to one million parts water.
- d) When the installation is filled all bib cocks (taps) shall be opened progressively and each allowed running until the water smells of chlorine.
- e) The installation shall be topped up and more sterilizer added.
- f) The installation shall then be left for three hours and shall then be tested for residual chlorine; if none is found, the installation shall be drained and the process repeated.
- g) The installation shall be finally drained and flushed with potable water before use.

### 10.31 CONNECTION TO RCC WATER TANKS. (PUDDLE FLANGE)

The contractor shall provide all inlets, outlets, washouts, vents, ball cocks, overflows control valves and all such other piping connections including level indicator to water storage tanks as called for. All pipes crossing through RCC work shall have puddle flanges fabricated from GI pipes of required size and length and welded to 6/8 mm thick MS plate. All puddle flanges must be fixed in true alignment and level to ensure further connection in proper order.

Full way gate valves of an approved make shall be provided as near the tank as practicable on every outlet pipe from the storage tank except the overflow pipe. Overflow and vent pipes shall terminate with mosquito proof grating with bronze screen on vent.

The overflow pipe shall be so placed to allow the discharge of water being readily seen. The overflow pipe shall be of size as indicated. A stop valve

shall also be provided in the inlet water connection to the tank. The outlet pipes shall be fixed approximately 75mm above the bottom of the tank towards which the floor of the tank is sloping to enable the tank to be emptied for cleaning.

The floor and the walls of the tank shall be tiled with glazed tiles up to the overflow level. Alternatively food grade epoxy to be applied.

### 10.32 DISINFECTION OF PIPING SYSTEM AND STORAGE TANKS

Before commissioning the water supply system, the contractor shall arrange to disinfect the entire system as described in the succeeding paragraph.

The water storage tanks and pipes shall first be filled with water and thoroughly flushed out. The storage tanks shall then be filled with water again and disinfecting chemical containing chlorine added gradually while tanks are being filled to ensure thorough mixing. Sufficient chemical shall be used to give water a dose of 50 parts of chlorine to one million parts of water.

If ordinary bleaching powder is used, the proportions will be 150 gm of power to 1000 litres of water. The power shall be mixed with water in the storage tank. If a proprietary brand of chemical is used, the proportions shall be specified by the manufacturer. When the storage tanks are full, the supply shall be stopped and all the taps on the distributing pipes are opened successively working progressively away from the storage tank. Each tap shall be closed when the water discharged begins to smell of chlorine. The storage tank shall then be filled up with water from supply pipe and added with more disinfecting chemical in the recommended proportions. The storage tank and pipe shall then remain charged at least for three hours. Finally the tank and pipes shall be thoroughly flushed out before any water is used for domestic purpose.

The pipe work shall be thoroughly flushed before supply is restored.

### 10.33 DISINFECTION OF INSTALLATION

The water supply installation shall be disinfected as per standards and as follows:

- (a) Tanks and pipes shall be filled and flushed out.
- (b) All bib cocks (taps) shall be closed.
- (c) Tanks and pipes shall be re-filled while adding a sterilising admixture containing 50 parts chlorine to one million parts water.
- (d) When the installation is filled all bib cocks (taps) shall be opened progressively and each allowed to run until the water smells of chlorine.
- (e) The installation shall be topped up and more steriliser added.
- (f) The installation shall then be left for three hours and shall then be tested for residual chlorine; if none is found, the installation shall be drained and the process repeated.
- (g) The installation shall be finally drained and flushed with potable water before use.

#### 10.34 STERILIZATION OF MAIN

After the pipe work has been tested and approved, but before it is coupled, it shall be sterilized with a solution of chloride of lime. The water supply installation shall be sterilized as per standards and as follows:

- a) Tanks and pipes shall be filled and flushed out.
- b) All bibcock (taps) shall be closed.
- c) Tanks and pipes shall be re-filled while adding sterilizing admixture containing 50 parts chlorine to one million parts water.
- d) When the installation is filled all bibcock (taps) shall be opened progressively and each allowed running until the water smells of chlorine.
- e) The installation shall be topped up and more sterilizer added.
- f) The installation shall then be left for three hours and shall then be tested for residual chlorine; if none is found, the installation shall be drained and the process repeated.

#### 10.35 CUTTING CHASES IN MASONARY WALLS

Cold water distribution pipes to fixtures and equipment exposed to view in the toilets, pantry, and sanitary compartments shall be chased into walls or floors or placed in wall cavities. The Contractor shall be responsible for cutting all notches, chases, and recesses in walls and floors and only a diamond cutter shall be used. The maximum size of conduit or pipe permitted to be concealed in floor slabs shall be 32 mm diameter unless otherwise approved by the Architect.

The chases up to 7.5 x 7.5 cm shall be made in the walls for housing GI pipes etc. These shall be provided in correct positions as shown in the drawings or directed by the Architects. Chases shall be made by chiselling out the masonry to proper line and depth. After the pipes etc. are fixed in chases, the chases shall be filled with cement mortar 1:2:4 or as may be specified and made flush with the masonry surface. The concrete surface shall be roughened with wire brush to provide a key for plastering.

Where pipes pass through beams or structural walls, subject to the approval of the Structural Consulting Engineer, the Contractor shall ensure that sizes and locations of openings required are formed in when the relevant beams or walls are cast.

#### 10.36 INSULATION

The insulation for hot water pipes shall be done as specified in Bill of Quantities and accordingly following guidelines shall be followed:

10.36.1            For Chased Internal Pipes:

All open hot water flow and return pipes (not in chase), shall be insulated with preformed fibrous pipe sections conforming to IS: 9842. Hot water pipes fixed in chase shall be insulated by wrapping 6 mm thick thermal insulation tubing's.

Elastomeric nitrile rubber closed cell pipe insulation for hot water supply pipe.

10.36.2            For External Piping:

Exposed pipes, on terrace and along ceiling level shall be insulated with either thermal tubing's of specified thickness or fibre glass wool blankets/mats, as specified in Bill of Quantities. After the insulation, all the pipes shall be protected with either 12mm thick smooth finished cement plaster (two layers of 6 mm thick of mix 1:2 Portland cement and fine sand) or they shall be cladded with 24 SWG aluminium sheet as specified in Bill of Quantities.

The specifications of the material shall be generally as follows, unless specified:

- a) Fibre glass wool      --      Blankets/mats of      50      mm thickness in the density of 24 kg/m<sup>3</sup>
- b) Elastomeric Flexible Material      --      Thermal Insulation tubing's of 6mm thickness with density of 60-90 Kg/m<sup>3</sup>.

Generally, following procedure shall be adopted:

- a) Cleaning the pipe surface to be insulated to make it free from dust & oil.
- b) Applying a layer of zinc chromate/anti-rust c.
- c) Fixing fibre glass wool blankets or mats/Elastomeric Flexible Tubing's as specified.
- d) Covering it all around with 24 gauge "wire netting with proper butt joint and tightly wrapped.
- e) Applying two layers of 6 mm thick each cement plaster in the ratio of 1:2 (1 cement: 2 fine sand).
- f) Applying weather proofing coating of Inculcate (Paints) OR of approved material over the cement plaster.
- g) For certain places, where exposed insulation is not to be plastered as specified in item (v) and (vi), then aluminium foil sheet of 24 gauge with 50 mm overlapping, fixed with self tapping recessed screwed shall be provided.

### 10.37 PAINTING / PIPE PROTECTION / INSULATION

Unless otherwise specified painting/ pipe protection/ insulation for pipes shall be measured and paid for separately. These shall be measured per linear metre along the center line of the pipe, over the finished surface and shall include all valves and fittings for which no deduction shall be made.

### 10.38 AIR RELEASE VALVES

Air release valve shall be installed as per specifications provided in BOQ. Table Commonly Adopted Size of Air Valves

Size of Main mm	Type of Valve	Size of Air Valve mm
80	Single air valve	20
100	Double air valve	40
125-200	Double air valve	50
250-350	Double air valve	80
400-500	Double air valve	100
600-900	Double air valve	150
1000-1200	Double air valve	200

- a) Air release valves shall be single acting type air valves with cast iron body and bronze/gunmetal internal parts and plastic float.
- b) Each air release valve shall be provided with a cast iron isolating sluice valve of specification given above.

### 10.39 MEASUREMENT AND RATES

Not Used

### 10.40 PRE-COMMISSIONING

- 10.40.1 Ensure that all pipes are free from debris and obstructions.
- 10.40.2 Check all valves for effective opening and closing action. Defects



TCE-10477A-PS-1000 C	<b>TATA CONSULTING ENGINEERS LIMITED</b>	SECTION: WRITE-UP
	<b>WATER SUPPLY, SANITARY &amp; DRIANGAE WORK</b>	SHEET 49 OF 71
<p>should be rectified or valves replaced.</p> <p>10.40.3 Ensure that mains have been connected to the respective pumps, underground and overhead tanks.</p> <p>10.40.4 Water supply should be available at main Underground tank.</p> <p>10.40.5 All main line Valves should be closed.</p> <p>10.41 <u>COMMISSIONING</u></p> <p>10.41.1 Fill Underground tank with water. Add 1kg fresh bleaching powder after making a solution to be added near inlet.</p> <p>10.41.2 Start Water Supply Pump and allow water to fill main Underground tank. Water will first fill the Raw Water tanks and then overflow to the fire water tank.</p> <p>10.41.3 After filling Overhead Reservoir drain the same to its one forth capacity through tank scour valve. (This is to ensure removal of all mud, debris etc. from the tank).</p> <p>10.41.4 Fill Overhead tank to full.</p> <p>10.41.5 Release water in the main lines by opening Valves in each circuit. Drain out water in the system through scour valves or fire hydrant in lower regions. Ensure clean water is now coming out of the system.</p> <p>10.41.6 Check all outlet points for proper operation by opening each valve and allowing water to flow for a few minutes. Also check for effective closure of valve.</p> <p>10.41.7 The entire water supply system should be disinfected with bleaching powder and system flush cleaned.</p> <p>10.41.8 Send four samples of water drawn from four extreme locations for testing for bacteriological test in sterilized bottles obtained from the concerned laboratory. (Laboratory personal may collect the samples themselves).</p> <p>11 <u>PUMPS (Submersible vertical inline Pumps)</u></p> <p>11.1. <u>Submersible vertical inline Pumps</u></p> <p>11.1.1 <u>SCOPE</u></p> <p>This specification covers the general design, materials, manufacture, shop inspection and testing at manufacturer's works, delivery at site, handling at site, installation,</p>		
		ISSUE P0

testing, commissioning and carrying out performance test of submersible pumps for domestic water with their accessories.

#### 11.1.2 CODES AND STANDARDS

The design, materials, manufacture, inspection, testing and performance of the submersible pumps shall comply with all currently applicable statutes, regulations and safety codes in the locality where equipment is to be installed. The equipment shall also conform to the latest editions of the relevant codes and standards existing as on the date 180 days prior to the deadline for submission of bids, unless otherwise specified. Nothing in this specification shall be construed to relieve the VENDOR of this responsibility.

#### 11.1.3 DESIGN REQUIREMENTS

- a) Pump shall be submersible, non-clog, wet pit installation, fixed or portable type and shall be suitable for working with the minimum liquid level. Fixed type pump set shall be with control panel with all safety devices. The pump shall be capable of delivering the required flow rate for both continuous and intermittent operations, at the specified operating conditions. The pump shall be designed to have minimum maintenance and easy accessibility to all components. Flow rate versus head curve shall have stable and continuously rising characteristics towards the shut-off with the highest at shut off. In case of unstable (dropping) characteristics the duty point shall be well away from the unstable region. Besides the actual flow rate versus head curve, curves for minimum and maximum impeller diameters shall also be shown.
- b) Pumps of a particular category shall be identical and shall be suitable for single as well as parallel operation with equal load division at any point in between the maximum and minimum system resistance. Components of identical pumps shall be inter-changeable.
- c) Pumps shall run smooth without undue noise and vibration. Noise level produced individually or collectively shall not exceed 85 dB (A) measured at a distance of 1.0 metres from the source in any direction. The overall vibration level shall be as per zones A and B of ISO 10816-1.
- d) The power rating of the pump driver shall be the larger of the following considering the frequency variation:
  - The maximum power required from zero discharge to run-out discharge at site climatic condition.
  - 110% of the power required at any operating point in between the maximum and minimum system resistance curves for any combinations of pumping.
  - 115% of the power required at the design point.
  - The critical speed of the pump shall be not less than 130% of the normal operating speed of the pump.
  - The pump set shall be capable of withstanding the accidental rotation in reverse direction. The direction of rotation shall be clockwise viewed from the drive end.

#### 11.1.4 CONSTRUCTION FEATURES

- a. Pump casing shall be of robust construction. Liquid passages shall be finished smooth and designed as to allow free passage of solids and stringy materials.
- b. Impeller shall be non-clog, vortex or vane type with smooth blunt inlet edge and large waterways so as to allow free passage of the large size solids. It shall be free from sharp corners and projections likely to catch and hold rags and stringy materials. The impeller shall be statically and dynamically balanced. Pumps up to 1000 M3/Hr shall have maximum 2 vanes; pumps having capacity 1000 m3/hr and above shall have maximum 3 vanes.
- c. Double Mechanical seals shall be provided to protect the motor from ingress of waste water along the shaft. The preliminary and secondary seals shall be oil- lubricated with tungsten carbide or silicon-carbide faces and they should be equipped with an electrical monitoring system for seal failure detection.
- d. Motor and Pump shall have a common shaft with bearings. The bearing shall be permanently greased and maintenance free.
- e. Portable type submersible pump should be equipped with pump base stand / legs, adequate length of chain and flexible type discharge hose pipe suitable for directly lowering into the well.
- f. Fixed type submersible pump shall be provided with a 90° duck foot bend for fixing to the concrete floor of the well. The joint between the pump discharge flange and the delivery piping shall be made by merely lowering the pump into guide system at the access level. It shall be provided with all necessary fixings for guiding the pumps during lifting/lowering.
- g. Replaceable shaft sleeves shall be securely locked or keyed to the shaft to prevent loosening. The surface hardness of the shaft sleeve shall be minimum 300 BHN.
- h. In addition to accessories listed in data sheet A, any other accessories required for safe and efficient operation of pump shall be provided.

#### 11.1.5 INDUCTION MOTOR FOR SUBMERSIBLE PUMPS

The submersible motor shall confirm to IS: 9283:2013.

#### 11.1.6 PERFORMANCE AND CHARACTERISTICS

- a. Motors shall be capable of giving rated output without reduction in the expected life span when operated continuously under varying voltage and frequency supply conditions.
- b. Motors shall be suitable for full voltage direct-on-line starting or star-delta starting.
- c. The starting current of motor shall not exceed 200% of rated full load current for star/delta starting and 600% of rated full load current for DOL starting, under any circumstances.
- d. Motors shall be capable of starting and accelerating the load with the applicable method of starting, without exceeding acceptable winding

temperatures, when the supply voltage is in the range 85% of the rated motor voltage to maximum permissible voltage, for category B type motors.

- e. The locked rotor current of the motor shall not exceed 600% of full load current (subject to tolerance as per the applicable standard).
- f. Motors shall be designed to withstand 120% of rated speed for two minutes without any mechanical damage, in either direction of rotation.
- g. The motor vibrations shall be within the limits specified in applicable standard unless otherwise specified for the driven equipment.
- h. Except as mentioned herein, the guaranteed performances of the motor shall be met with tolerances specified in applicable standard (IS: 9283:2013).
- i. Protection against increase in stator winding temperature, bearing temperature, leakage in stator housing and terminal box shall be provided. Minimum 3 nos. thermostats in series to be provided to sense the stator winding temperature. Sensors to be provided to detect leakage of waste water into oil housing.

#### 11.1.7 SUBMERSIBLE CABLE

- a. The cable shall be PVC insulated and PVC sheathed, flexible, 3 core flat type. The size of the conductor shall be adequate for continuous use under water and air.
- b. In case a joint is required to be made between the lead cable supplied with the motor and the user's cable connectors, a detailed procedure of cable jointing to make a watertight joint shall be provided by the manufacturer.
- c. The size of the conductor and length of cable should be suitably selected so that the voltage drop at motor terminals does not exceed 3 percent of the rated voltage.

#### 11.1.8 EARTHING

- a. Earthing of the motor shall be done in accordance with the relevant provisions of IS: 3043:1987.
- b. For fixed installation, earthing connection may be made to discharge pipe clamp.

#### 11.1.9 INSULATION

- a. Any joints in the motor insulation such as at coil connections or between slot and end winding sections shall have strength equivalent to that of the slot sections of the coil.
- b. The insulation shall be given tropical and fungicidal treatment for successful operation of the motor in hot, humid and tropical climate. The tropicalising treatment shall be as per the applicable standard.

#### 11.1.10 TEMPERATURE RISE

The temperature-rise test of the motor shall be taken with the motor coupled to the suitable pump to give the full load output of the motor. When the various temperatures are stabilized, the set is stopped and the temperature-rise of the

stator winding by the resistance method shall not exceed 35°C at rated voltage and 45°C at 85% of the rated voltage. During the test, the temperature of the cooling water may not exceed 45°C. As the cable resistance will also be substantial, it is necessary that while calculating the temperature rise by resistance method, due care is taken to account for the correct hot and cold resistance of windings.

#### 11.1.11 CONSTRUCTION FEATURES OF MOTOR

The motor shall be suitable for continuous use in fully or partially submerged condition. A built-in cooling system if required shall be provided to allow the motor to operate continuously at its rated output regardless of whether the electric motor is submerged or not by providing either external or internal cooling arrangement.

#### 11.1.12 TESTS AND INSPECTION

- a. Hydro-test pressure on casing shall be 1.5 times maximum discharge head or twice differential head whichever is higher. Maximum discharge head is defined as the sum of the shut-off head and maximum suction head. Unless otherwise stated in data sheet A, the hydrostatic tests on the casing shall be conducted for a minimum duration of 30 minutes.
- b. The pumps shall be tested in accordance with HIS, ISO 9906 and IS 5120, at rated speed at MANUFACTURER's works to measure capacity, total head, efficiency and power. The negative tolerance on efficiency shall be limited to 2.5% and not 5% as indicated in IS 5120. These tests shall form the basis for acceptance of pumps except for vibration and noise. The pumps shall be tested over the range covering from shut-off head to the maximum flow. The duration of the test shall be minimum one (1) hour. Minimum five (5) readings approximately equidistant shall be taken for plotting the performance curves.
- c. After installation, the pumps shall be subjected to testing at site also. If the site performance is found not to meet the requirements regarding vibration and noise as specified. The equipment shall be rectified or replaced by the VENDOR, at no extra cost to the EMPLOYER.

#### 11.1.13 PERFORMANCE GUARANTEE

Performance parameters to be guaranteed by the VENDOR and tolerances permitted shall be as indicated. BIDDER shall confirm acceptance of these by indicating values in data sheet B. Pump or any portion thereof is liable for rejection, if it fails to give any of the guaranteed performance parameters.

#### 11.1.14 DRAWINGS

The following drawings shall be submitted by the BIDDER along with their proposal. Preliminary outline dimensional drawing showing details of pump set, installation details, civil foundation, clearances, minimum submergence, etc. Performance curves for capacity vs total head, efficiency, and input to motor. The

capacity range shall be zero flow to run out flow. Typical cross-sectional drawing showing constructional details.

#### 11.2. SUMP PUMP (DE-WATERING @Pump room) –

##### Submersible

These shall be fully submersible with a fully submersible motor. The pumps shall be provided with an automatic level controller and all interconnecting power and control cabling which shall cause the pumps to operate when the water level in the sump rises to a preset level and stop when the preset low level is reached.

Pumps for drainage shall be single stage, single entry.

Pump shall be C.I. casing and C.I. two vane open type with a dynamically balanced impeller connected to a common shaft of the motor. The vane for sewage pump will be open type, while for drainage pump, etc. it will be of semi open type. The MOC of the sump shall be in accordance to schedule of quantity.

Stuffing box shall be provided with mechanical seals.

Each pump shall be provided with a suitably rated induction motor suitable for 415 volts, 3 phases, 50 Hz A.C. power supply.

Each pump shall be provided with in built liquid level controller for operating the pump between predetermined levels.

The pumping set shall be for stationary application and shall be provided with pump connector unit. The delivery pipe shall be joined to the pump through a rubber diaphragm, and bend and guide pipe for easy installation.

Pump shall be provided with all accessories and devices necessary and required for the pump to make it a complete working system. Each sump pump shall have all isolation valves, check valve on delivery line etc all complete.

Sump pump shall be complete with level controllers, power and control switch gear, Auto/off/Manual switches, pumps priority selections and control and power cabling up to motor and controller/probes etc. (Including earthing). Level control shall be such that one pump starts on required level, 2nd pump cuts in at high level and alarms is given at extra high level. All level controllers shall be provided with remote level indications. Submersible pumps shall be provided / included with float switches, control panel, SS 304 guide rail, SS 304 lifting chain, pump pedestals.

##### Motor Design

The pump motor shall be a squirrel cage induction, housed in air filled water-tight enclosure. Oil filled motors are not acceptable. The stator windings shall

TCE-10477A-PS-1000 C	<b>TATA CONSULTING ENGINEERS LIMITED</b>	SECTION: WRITE-UP
	<b>WATER SUPPLY, SANITARY &amp; DRIANGAE WORK</b>	SHEET 55 OF 71

be Class "F" insulation (155 degree C or 311 degree F) for general usage and class 'H' insulation (180 degree C or 317-8 grade 2) for submersible type.

The stator shall be heat shrunk fitted into the enclosure and shall not use bolts, pins or other fasteners that penetrate through the stator enclosure. The starter shall be equipped with a thermal switch embedded in series in the coils of the stator windings to protect the stator from wheel.

The motors shall be designed for continuous running duty type at 415 volts, 3 phase, 50 Hz power supply and capable of sustaining a minimum of 20 starts/stops per hour.

Between stator housing and pump, a tandem seal arrangement will be provided with an oil barrier. Both seals run in oil, allowing dry running without seal damage. Both seals shall be of the rubber bellows or metallic bellow type with positive drive between shaft and rotating seal face.

ISSUE P0
-------------

SPEC. NO.	<b>TATA CONSULTING ENGINEERS LIMITED</b>	SECTION: C1
TCE.10477A-PP-6041-60540-P0	<b>SCOPE OF WORK &amp; SPECIFIC REQUIREMENT-MECHANICAL</b>	SHEET 1 OF 22

**SCOPE OF WORK AND TECHNICAL SPECIFICATION**  
**FOR FIRE PROTECTION SYSTEM**

FILE NAME: TCE.10477A-PP-6041-60540-P0

Proprietary rights of the information contained herein belong to Tata Consulting Engineers Limited (TCE). This information is intended to be used for the mentioned purpose/project only. In case of misuse of information and any claim arising thereof, cost and consequence will be on the party misusing the information.

ISSUE P0
-------------



SPEC. NO.	<b>TATA CONSULTING ENGINEERS LIMITED</b>	SECTION: C1
TCE.10477A-PP-6041-60540-P0	<b>SCOPE OF WORK &amp; SPECIFIC REQUIREMENT-MECHANICAL</b>	SHEET 2 OF 22

**1.0 EQUIPMENT & SERVICES TO BE PROVIDED BY THE CONTRACTOR**

1.1 This specification covers the general requirements of design, preparation of detailed drawings, supply of material, manufacture, testing, inspection at BIDDER'S works, packing, forwarding, transportation, transit insurance, delivery at site, unloading and handling at site from storage area to workplace, erection / installation, testing, commissioning at site and carrying out performance / acceptance tests of the equipment, warranty certificate as per requirement, materials and services as per enclosed data sheet and other documents for fire protection system (FPS).

1.2 The scope of work is as listed below;

- a. This Package is for provision of Fire Protection System for ICCC at Guwahati, Assam.

1.3 The fire protection systems in this package consist of the following types:

- a. Pump room shall be included pumps with Electrical Panel ,controller ,cabling, piping and fitting & ancillary equipment as per technical specifications, system description, schedule of quantities.
- b. Sprinkler system and hydrant system shall be considered for ground floor as per technical specifications, system description, schedule of quantities.
- c. Sprinkler system & hydrant system shall be considered as per technical specifications, system description, schedule of quantities.
- d. Fire extinguisher shall be supplied by client/contrator as free issue material (FIM) but unloading, shifting, storing and positioning of fire extinguishers is the responsibility of FPS contractor. If by any means the extinguishers are depressurised it is FPS contrator's responsibility to get them replenished.
- e. Gas based fire suppression system for data center and command and control center(CCC) shall be supplied as per technical specifications, system description etc. all complete.
- f. Fire sealant shall be considered for ground floor & all floors vertical & horizontal penetration.FPS contractor's scope shall be included making of well & good due to required rebar, binding tar & proper qulity frame chequered plate structure.
- g. First fill of all consumables including grease, lubricants, oil and diesel fuel.

REV. NO.	P0								ISSUE
	INITIALS	SIGN.	INITIALS	SIGN.	INITIALS	SIGN.	INITIALS	SIGN.	
PPD. BY	MA								ISSUE P0
CHD. BY	MA								
APD. BY	MAM								
DATE	13-05-2020								

SPEC. NO.	<b>TATA CONSULTING ENGINEERS LIMITED</b>	SECTION: C1
TCE.10477A-PP-6041-60540-P0	<b>SCOPE OF WORK &amp; SPECIFIC REQUIREMENT-MECHANICAL</b>	SHEET 3 OF 22

Contractor shall also refill all the consumables after successful testing at the time of handing over the system to Employer.

- h. Warpping & coating of underground pipes shall be as per IS 10221 and protection of pipe insulation to be covered with 100mm soft sand. All supports for underground and above ground pipes shall be done by FPS contractor (near buildings).
- i. Making holes/openings in walls and sealing them back to the satisfaction of Engineer in Charge.
- j. Automatic pump starting system with all accessories, wiring and connections and pressure switches.
- k. Pressure gauges 1/2" syphon pipe shall be SS with GI half coupling tapping, isolation valves and piping, bleed and block valves etc complete.
- l. Diameter 50mm pipe and fittings shall be with threaded fitting and 65 mm dia and above will be grooved fittings.
- m. All valves above 50mm dia shall be UL/FM approved grooved valve.
- n. Grooved coupling shall be UL/FM approved.
- o. Obtaining the approval from CFO & Local fire authority by FPS contractor including submitting the forms, fees, all relevant drawings, interaction with the authorities etc shall be by FPS contractor.
- p. Test certificates, FM approved documents, Operating & maintenance Manuals of all equipment's / fittings dully signed and certified by bidder.
- q. Updating and submission of "As Built" drawings
- r. Any other point not listed above but required for successful completion of the fire protection system should be in the scope of the bidder.
- s. FM/UL approved breaded type flexible sprinkler pipe shall be provided wherever false ceiling are considered in Architectural drawings.
- t. All first isolation valve(only at pump suction near to UG tank) next to puddle flange shall be one end flange and other end grooved.

1.4 The design engineering for this package has been done as per National Building Codes of India (NBC) part IV guidelines 2016, Local Fire Authority requirements; and schematic/ general layout drawings for fire pump house equipments, hydrant, sprinkler & fire extinguisher have been prepared by the Engineer. However, as part of design engineering, the following shall be in the scope of bidder:

- a. Preparation of detailed calculation, specific drawings such as general arrangement drawings, fabrication/piping and isometric drawings for hydrant system, sprinkler system, vendor drawings of bought out items, pipe supports drawings, etc.
- b. Preparation and submission of detailed engineering drawings based on these specifications and latest base drawings / Revit model made available to the successful bidder.

ISSUE P0
-------------

SPEC. NO.	<b>TATA CONSULTING ENGINEERS LIMITED</b>	SECTION: C1
TCE.10477A-PP-6041-60540-P0	<b>SCOPE OF WORK &amp; SPECIFIC REQUIREMENT-MECHANICAL</b>	SHEET 4 OF 22

- c. Preparation and submission of as-built drawings in soft copies and 6 sets hard copies to Employer
  - d. Preparation and submission of one soft and 6 sets hard copies of approved Operation & Maintenance Manual for fire-fighting systems.
  - e. Occupancy certification from local CFO as part of FPS vendor scope.
  - f. Supporting arrangements needed (indoor & outdoor) for the piping, valves and instrumentation, operating platforms / cross-overs etc in pump house
  - g. Valve chambers as necessary shall be include of frame cover heavy duty with cover from FFL.
- 1.5 Supply and application of painting shall be as per IS 5 for piping, fitting, valves, equipment, hose cabinets and structural steel and auxiliary steel for supports. The paint should have minimum of 3 years of warranty. In case of failure the contractor should repaint at its own cost.
- 1.6 For electrical works separate specification will be shared.
- 1.7 For instrumentation separate specification will be shared.
- 1.8 Any item which may not have been specifically mentioned herein but are needed to complete the equipment / system shall also be treated as included and the same shall also be furnished and erected, unless otherwise specifically excluded as indicated.
- 1.9 Pump inspection shall be arranged for all pumps with performance test.  
**Important Notes:-** Individual pump testing at factory & Entire pump set performance & sequence of operation testing at factory.
- 1.10 The pump should be tested for bench mark at factory and shall be approved by the Local fire Authority.
- 1.11 Vibration elimination arrangements of cushy foot mountings (anti-vibration pads) for all pumps sets.
- 1.12 All puddle flanges and nozzle for RCC fire water tank will be in scope of GCC contractor.
- 1.13 All auxiliary support steel shall be glavanized.
- 1.14 Companion flanges,Puddle flanges ,all nuts, bolts shall be galvanized.
- 1.15 All kinds of supports as necessary for piping.
- 1.16 All anchor bolts, nuts, washers and inserts to be embedded in concrete for the equipment and piping.
- 1.17 The flanges, companion flanges with nuts, blots & gaskets for nozzles on fire water reservoir shall be in the scope of contractor .

ISSUE P0
-------------

SPEC. NO.	<b>TATA CONSULTING ENGINEERS LIMITED</b>	SECTION: C1
TCE.10477A-PP-6041-60540-P0	<b>SCOPE OF WORK &amp; SPECIFIC REQUIREMENT-MECHANICAL</b>	SHEET 5 OF 22

1.18 Fire fighting final flushing/ Hydrotesting to be witnessed by client/consultant & PMC.

1.19 For routing piping, cabling etc. breaking / making of opening in wall along with re packing or core packing, etc. shall be carried out by Contractor at no extra cost.

1.20 For pipes of fire water system that enter the buildings, the following will be in scope of contractor:

If the pipe has to cross the retaining wall, then a correct size opening shall be made in the wall and after the pipe is installed, the opening shall be sealed both on inside and outside by using proper sealants as approved by engineer-in-charge (not bitumen). Where pipe has to cross brick / block work wall, then a correct size opening shall be made in the wall, an appropriate sleeve installed and after the fire water pipe is installed, the opening between fire water pipe and sleeve shall be sealed both on inside and outside by using proper sealants as approved by engineer-in-charge.

1.21 Building Automation System

Fire fighting Contractor shall include the interface to Building Automation System Contractor to provide the interface of Ethernet port with connecting provision of CAT 6 along with Patch card will be readable to BMS.

Important Notes:- All Fire pump electrical panel shall have BMS connectivity with modbus RS485.

Following minimum required points shall transferred to BMS system using soft-integration either BACnet over IP, MODBUS or RS-485.

- Hydrant Jockey pump running
- Hydrant Jockey pump fails to start
- Hydrant Jockey pump trip on overload
- Hydrant Jockey pump in manual mode
- Sprinkler Jockey pump running
- Sprinkler Jockey pump fails to start
- Sprinkler Jockey pump trip on overload
- Sprinkler Jockey pump in manual mode
- Motor driven hydrant main pump running
- Motor driven hydrant main pump in manual mode
- Motor driven hydrant main pump failed to start
- Motor driven sprinkler main pump running
- Motor driven sprinkler main pump in manual mode
- Motor driven sprinkler main pump failed to start
- Motor driven standby pump running
- Motor driven standby pump in manual mode
- Motor driven standby pump failed to start
- Hydrant Engine driven standby pump running
- Hydrant Engine driven standby pump fail to start.

ISSUE P0
-------------

SPEC. NO.	<b>TATA CONSULTING ENGINEERS LIMITED</b>	SECTION: C1
TCE.10477A-PP-6041-60540-P0	<b>SCOPE OF WORK &amp; SPECIFIC REQUIREMENT- MECHANICAL</b>	SHEET 6 OF 22

- Hydrant Engine driven standby pump in manual mode
- Diesel fuel tank level low
- Hydrant Engine Driven Pump Battery charge failure
- Sprinkler Engine driven standby pump running
- Sprinkler Engine driven standby pump fail to start.
- Sprinkler Engine driven standby pump in manual mode
- Diesel fuel tank level low
- Diesel fuel tank level low
- Sprinkler Engine Driven Pump Battery charge failure
- Low pressure in discharge header of the system
- Level Switch – High water level
- Level Switch – Low water level
- All isolation valves, wherever provided with supervisory switch (non-padlock valves)
- Spare – 10% of total no's windows

**2.0 EQUIPMENT & SERVICES TO BE PROVIDED BY OTHERS**

- 2.1 The following are the equipment and services that shall be provided to the CONTRACTOR. However details of these requirements shall be specified by the CONTRACTOR within the stipulated time frame.
- 2.2 Engineering and construction of all equipment foundations required for this system. For this purpose, CONTRACTOR to provide all required inputs to client in time. Important note: Adequately designed RCC foundations for fire water pump sets with foundation bolt pockets will be provided in the fire water pump house. CONTRACTOR scope includes procurement and grouting of appropriate HILTI bolts (or equivalent make acceptable) based on the actual base frame sizes and pump set loads.
- 2.3 Fire doors or walls as barriers.

**3.0 SPECIFIC REQUIREMENTS / INSTRUCTION TO BIDDERS**

- 3.1 GP-2 grouting for equipment and Grouting supports, supply of –grouting material such as cement, sand, necessary form work etc. is fire fighting contractor responsibility.
- 3.2 No Separate payment will be made for necessary galvanized structural supports of piping.
- 3.3 The FPS contractor shall ensure that other utilities/items and aesthetics are not damaged or disturbed due to the installation activities. if contractor is responsible for any mistake or damages other facility, it should be set right by the contractor free of cost to owner.
- 3.4 Caps over concealed sprinklers shall be fitted only after painting of ceiling (by others) is completed.

ISSUE P0
-------------

SPEC. NO.	<b>TATA CONSULTING ENGINEERS LIMITED</b>	SECTION: C1
TCE.10477A-PP-6041-60540-P0	<b>SCOPE OF WORK &amp; SPECIFIC REQUIREMENT-MECHANICAL</b>	SHEET 7 OF 22

3.5 Sprinklers shall be masked off prior to painting. Any painted sprinkler or sprinkler coated with plaster of Paris is to be replaced by CONTRACTOR at no cost to client.

3.6 Method of Testing the System: The following tests shall be carried out for ensuring that the system and various components meet the system specifications and the integrity.

3.7 Method of Testing System:

Hydrant & Sprinkler piping	<ul style="list-style-type: none"> <li>To withstand min. hydro-test at the pressure 1.5 times the max. working pressure i.e. <math>12 \times 1.5 = 18 \text{ kg/cm}^2(\text{g})</math> for two hours .</li> <li>Leak test: system to be tested at maximum operating pressure for functional test at operating pressure for 24 hours after fixing all components.</li> <li>The grooved end of any pipe should be terminated by suitable coupling and plug enough to withstand the test pressure/system pressure.</li> </ul>
Fire water pump	<ul style="list-style-type: none"> <li>Shall be capable of delivering not less than 150 % of rated capacity at a head of not less than 65 % of the rated head</li> </ul>
Drain Piping	<ul style="list-style-type: none"> <li>To withstand min. hydro-test at the pressure 1.5 times the max. working pressure i.e. <math>12 \times 1.5 = 18 \text{ kg/cm}^2(\text{g})</math> for two hours .</li> </ul>
Cleaning of Piping and Equipment after testing (Flushing)	<ul style="list-style-type: none"> <li>The piping shall be flushed with clear water, intended for fire protection services, after completion of tests.</li> <li>Systems shall be flushed until the outgoing water from the pipes becomes clear.</li> </ul>
Wrapper coating on underground pipes	Holiday testing
Other components	As per data sheet / requirements specified.

#### **4.0 CODES AND STANDARDS**

4.1 All equipment, systems and works covered under this specification shall comply with all currently applicable statutes, regulations, standards and safety codes in the locality where the equipment will be installed. All equipment and systems shall comply in all respects with requirements of codes and standards.

4.2 Other national standards established to be equivalent or superior to the codes and standards specified are also acceptable. The BIDDER shall furnish English translation of all standards specified in this specification.

ISSUE P0
-------------

SPEC. NO.	<b>TATA CONSULTING ENGINEERS LIMITED</b>	SECTION: C1
TCE.10477A-PP-6041-60540-P0	<b>SCOPE OF WORK &amp; SPECIFIC REQUIREMENT-MECHANICAL</b>	SHEET 8 OF 22

4.3 In the event of any conflict between the codes and standards referred to in the specification and the requirements of this specification, the more stringent of this requirement shall govern.

4.4 All codes and standards referred to in this specification are latest editions of respective codes and standards.

#### **5.0 MAINTENANCE REQUIREMENTS**

5.1 In order to carry out preventive maintenance, it should be possible to readily disassemble, repair, and reassemble the equipment system in the shortest period and to attend to any defect by a minimum disassembly.

5.2 The BIDDER shall furnish one complete set of any special maintenance tools required for normal maintenance of equipment.

5.3 The BIDDER shall confirm that space shown for the equipment is adequate from point of view of access, easy maintenance and for day to day operation.

5.4 Bidder to submit operation and maintenance manual, spare list inclusive of critical spare parts, list of service centres for equipments.

5.5 All system must have convenient maintenance characteristics including :

- a) Minimum disturbance to production during preventive maintenance.
- b) Easy access to replacement part which can be installed by personnel with minimum skill.

#### **6.0 GUARANTEES AND PERFORMANCE REQUIREMENTS**

##### 6.1 GENERAL

The fire protection system shall perform satisfactorily to meet the guarantee requirements specified to the entire satisfaction of the client and statutory requirements.

##### 6.2 NOISE AND VIBRATION

Amplitude of vibration at bearing of rotating equipment shall conform to ISO: 10816-1.

Vibration isolators of proven design shall be furnished by the BIDDER for preventing the transmission of vibration from the equipment (fire water pumps, etc.) to the other neighbouring equipment and structure.

Inertia block with anti vibration pad shall be provided above neoprene-concept drawing required from FPS contractor.

#### **7.0 PAINTING**

7.1 All Paints should have minimum 3 years of warranty, In case of any peeling of paint in between. Contractor shall repaint the same at its own cost.

ISSUE P0
-------------

SPEC. NO.	<b>TATA CONSULTING ENGINEERS LIMITED</b>	SECTION: C1
TCE.10477A-PP-6041-60540-P0	<b>SCOPE OF WORK &amp; SPECIFIC REQUIREMENT-MECHANICAL</b>	SHEET 9 OF 22

- 7.2 Painting in the immediate vicinity of any electrical and rotating equipment and / or pipe in service shall not be performed without the prior written approval of the PURCHASER for the specific structure, equipment, or pipe to be painted.
- 7.3 The CONTRACTOR's scaffolding shall be erected, maintained and dismantled without damage to structures, machinery, equipment or obstruction to work of other CONTRACTORS.
- 7.4 All surfaces such as light gauge / glasses, required for clear visual observation shall be cleaned after paint application.
- 7.5 Special care shall be taken to avoid any paints from dropping on the machined moving parts of equipment, name plates or indicator dials of instruments and control valves. Prior to paint application or spraying paint removable adhesive tape shall be used to cover these.
- 7.6 On final completion of all work, the CONTRACTOR shall leave the entire premises within the site of his operation clean and free from all rubbish resulting from his painting operation and shall remove any paint or other blemishes caused by him on adjacent walls, windows, equipment and finished surface.
- 7.7 All piping including fittings and coupling shall be painted after hydro test only. wherever required necessary polythene cover to be provided for protection during painting.
- 7.8 The iron and steel surfaces shall be thoroughly cleaned of all rust, scale, grease or oil by manual or power tools and then primer coat shall be applied.
- 7.9 The PURCHASER reserves the right to inspect the cleaning down and painting operations at any stage and if required by PURCHASER/ENGINEER unsatisfactory surface preparation or paint application shall be emended at CONTRACTOR's expense.
- 7.10 On job site, no painting shall be carried out in a dust laden atmosphere or under unsuitable weather conditions viz. when raining or when metal surfaces are damp or when condensation is likely to affect the paint film before it is dry.
- 7.11 Surface preparation for underground and aboveground pipe shall be by thorough wire brushing and any additional cleaning as required.
- 7.12 All the exposed surfaces of equipment (other than pumps) and piping shall be painted with 1 coat of zinc chromate primer and 2 coats of synthetic enamel paint. Shade of finish paint shall be as per IS:5 PO red colour minimum thickness (DFT) of paint shall be as under:-
- a. Primer - 1 coat of Etch primer for GI pipe and remaining structure zinc chromate primer with minimum dry film thickness (DFT) 25 microns per coat.
  - b. Finish - 2 coat of synthetic enamel paint with minimum dry film thickness (DFT) 25 microns per coat. Total DFT 50 microns minimum.

**8.0 BASIS OF DESIGN AND SYSTEM DESCRIPTION**

ISSUE P0
-------------



SPEC. NO.	<b>TATA CONSULTING ENGINEERS LIMITED</b>	SECTION: C1
TCE.10477A-PP-6041-60540-P0	<b>SCOPE OF WORK &amp; SPECIFIC REQUIREMENT-MECHANICAL</b>	SHEET 10 OF 22

### 8.1 Hydrant System Description

- a) Design of External Hydrant system will be done as per NBC -2016 and IS: 13039-2014.
- b) The hydrant system comprises of :
  - External and internal hydrant valves with hoses in hose boxes
  - Hose reels at internal hydrant locations
  - Underground and above ground fire water piping with necessary valves.
  - Pumps comprising – one motor driven pump, one standby diesel engine driven pump and a line pressurization jockey pump.
  - Necessary Panel, cables and instrumentation.
- c) As per IS 13039, clause 4.12, the external hydrants (single outlet hydrant valve) are planned at the distance of 45m apart and within 2m -15m from the building. For each external hydrant, a hose box with two nos. Hoses with coupling, each of 15m length, will be provided.
- d) Internal hydrants (As per NBC , Table-8, clause 5.1.1, single outlet hydrant valve) will be provided for fighting fire within the buildings .The internal hydrants shall be provided in sufficient quantities such that no portion of the floor is more than 30m from an internal hydrant. For each internal hydrant a hose box with two nos. Hoses with coupling, each of 15m length, and a first aid hose reel of 30m length will be provided. The hose reel enables fighting low intensity fire with lesser water discharge. All the internal hydrants are placed on wet risers which are connected to main hydrant line with isolation valve.
- e) A separate external hydrant main pipe shall be taken from discharge header of respective pump sets.
- f) Internal hydrant main pipe connected to ring main wet riser pipe tapping.
- g) Fire brigade inlet connection shall be provided to enable fire brigade vehicles to pump in water into the hydrant system / fire underground tank.
- h) Draw out connection with foot valve arrangement shall be provided to enable the fire brigade teams to draw water from the fire water storage tanks in case of any eventuality.
- i) Overhead tank shall be provided at terrace level of each building.

### 8.2 Sprinkler System Description

- a) Design of Sprinkler system shall be as per NBC-2016 and IS: 15105-2002.
- b) The sprinkler system comprises of

ISSUE P0
-------------

SPEC. NO.	<b>TATA CONSULTING ENGINEERS LIMITED</b>	SECTION: C1
TCE.10477A-PP-6041-60540-P0	<b>SCOPE OF WORK &amp; SPECIFIC REQUIREMENT-MECHANICAL</b>	SHEET 11 OF 22

Sprinklers (quartz- pulb color should not change up to 10 years duration otherwise to be replaced free of cost .)

Alarm valves

Underground and above ground fire water piping with necessary components (i.e. Isolation Valve, test and drain connection, flow switch etc).

Pumps comprising – one motor driven pump and a line pressurization jockey pump.

Necessary Panel, cables and instrumentation.

- c) The proposed building is classified as “Moderate Hazard Class” as per IS 15105, clause 5.1.2
- d) As per IS 15105, Clause 8.1.2, sprinkler system will be designed with minimum design density of 5 l/min/m<sup>2</sup> over an assumed maximum area of operation (AMAO) of 360 m<sup>2</sup> for roof/ceiling sprinklers.
- e) As per IS 15105 clause 11.2.2, the maximum coverage area of each sprinkler shall be 12 m<sup>2</sup>.
- f) The Minimum Sprinkler Discharge Pressure in a hydraulically calculated Sprinkler System should not be less than 0.35 bars, (Table 29 of IS 15105) for Moderate Hazard.
- g) **Important Note:-** Please note that as per NBC clause no 5.1.3, (h) "Sprinkler installation control valves, shall be installed inside the fire pump room". However, in this case a common fire pump room. Hence it was proposed to take only a single sprinkler pipe from fire pump house delivery header which will feed the ICV located in the respective building.
- h) As per NBC clause no 5.1.3, (g), the maximum floor area on any one floor to be protected by sprinklers supplied by any one sprinkler system riser from an installation control valve shall be based on system protection area limitations considering maximum floor area on any one floor to be 4500 m<sup>2</sup> for all occupancies except industrial and hazardous occupancies.
- i) As per NBC clause no 5.1.3, (c), the concealed areas (area between true ceiling and false ceiling) greater than 800 deep and containing combustible material shall also be protected with upright sprinkler system.
- j) The sprinkler quartz bulb rating for all sprinkler areas of buildings shall be 68 deg C for, internal and air conditioned areas.
- k) The sprinkler system risers will be tapped from sprinkler ring main pipe. These risers shall feed sprinkler system on respective floors through zone control valves, flow switch and test & drain connections. The zone control isolation valves will be provided with tamper switch. Signal from isolation

ISSUE P0
-------------

SPEC. NO.	<b>TATA CONSULTING ENGINEERS LIMITED</b>	SECTION: C1
TCE.10477A-PP-6041-60540-P0	<b>SCOPE OF WORK &amp; SPECIFIC REQUIREMENT-MECHANICAL</b>	SHEET 12 OF 22

valve tamper switch and flow switch should be taken to the annunciation panel.

### 8.3 **Portable Fire Extinguisher**

a) The portable extinguishers would be so located / placed that a person would not have to travel more than 10 m or 15m to fetch an extinguisher. Also, every room/enclosure would be provided with minimum of one extinguisher.

b) Following fire extinguishers are proposed as per IS 2190.

One 4.5kg Co2 extinguishers for every 100m<sup>2</sup> of area in office, computer installation, ODC & lobby etc.(Travel distance will not be more than 10m)

One 9 litre foam type or One 6kg Dry powder type extinguisher with minimum of 2 extinguishers for Kitchen. (Travel distance will not be more than 15m)

### 8.4 **Operation Philosophy Of Pumping System**

a) Pumping system in line with Fig-12 of NBC-2016 has been provided.

Pumps catering to hydrant system and those to sprinkler system have all been connected to a common discharge header. In this discharge header there are two normally closed isolation valves and a non-return valve between the hydrant portion and sprinkler portion. In normal circumstances, when the isolation valves remain closed, the hydrant system and sprinkler system operate in isolation. When the isolation valves are opened the non-return valve ensures that it will be possible for hydrant system to feed the sprinkler system, but not vice-versa.

There is one normally closed connection between the discharge lines of the two jockey pump which can be opened in the eventuality of one of the jockey pumps being inoperable and ensures that either jockey pump can be used for both systems.

### 8.5 **Fire Water Pump House and Underground Fire Water Tank**

a) As per design requirement for proposed building, underground fire tank capacity is 1,00,000 litres with a partition at 50,000 liters for easy maintenance.

b) As per design requirement for proposed buildings, following Fire Water Pumps shall be provided in the pump house.

ISSUE P0
-------------

SPEC. NO.	<b>TATA CONSULTING ENGINEERS LIMITED</b>	SECTION: C1
TCE.10477A-PP-6041-60540-P0	<b>SCOPE OF WORK &amp; SPECIFIC REQUIREMENT-MECHANICAL</b>	SHEET 13 OF 22

SL NO.	DESCRIPTION OF FIRE PUMP	QTY (NO.)	CAPACITY (LPM)	Head(m)
1	Electrical motor driven Main Hydrant Pump set.	01	2280	70
3	Diesel engine driven Hydrant Pump set.	01	2280	70
5	Electrical motor driven Jockey Pump set.	01	180	70

- c) Electrical pump will cater to the requirement of hydrant and sprinkler system. Diesel engine driven fire pump is provided to ensure operation of the system in case of non-operation of main pumps and in case of electrical power failure. Jockey pumps compensate for pressure drop and line leakage in the hydrant and sprinkler installation and ensure that system is always pressurized.
- d) It will be ensured that the fire water pumps operate under positive suction.
- e) As per NBC Fig 12 ,separate header of hydrant and sprinkler will be provided from the common delivery header for hydrant and sprinkler system.
- f) The pump operation will be meet the IS guideline & NFPA.

\* - The pump head calculation shall be submitted by the contractor during hydraulic analysis(by pipenet software) and pump power requirement shall be submitted and coordinated with electrical contractor.

The jockey pump shall be used for make-up of leakages. The start-stop of jockey pump and start of fire water pumps shall be automatic by sensing of falling header pressure by individual pressure switches.

A pressure switch shall be provided on header for sensing header pressure low.

A pressure gauge shall be provided at discharge of each pump.

The system shall be pressurised at 13 kg/cm<sup>2</sup>(g). Pump shall be installed with pressure switches in the common delivery header for automatic starting in the following tentative sequence:

Sr. No.	Description	Set Pressure (in kg/cm <sup>2</sup> g)
01.	Jockey pump – 1 start * (sprinkler system)	12.5
02.	Jockey pump – 1 stop * (sprinkler system)	13

ISSUE  
P0

SPEC. NO.	<b>TATA CONSULTING ENGINEERS LIMITED</b>	SECTION: C1
TCE.10477A-PP-6041-60540-P0	<b>SCOPE OF WORK &amp; SPECIFIC REQUIREMENT-MECHANICAL</b>	SHEET 14 OF 22

03	Jockey pump – 2 start * (Hydrant system)	12.5
04	Jockey pump – 2 stop * (Hydrant system)	13
05.	Main Sprinkler pump-start *	10
06.	Main Sprinkler pump-stop*	Manually
07.	Main Hydrant pump-start*	9
08.	Main Hydrant pump-stop*	Manually
09.	Standby Hydrant pump-start*	8
10.	Standby Hydrant pump-stop *	Manually
11.	Standby Sprinkler pump-start *	7
12.	Standby Sprinkler pump-stop *	Manually

\* The above settings are indicative and actual parameters will be finalised by contractor. In addition to above Signals, Pump “Running” & “Fail To Start” signal shall be provided & necessary Pressure switches shall be envisaged. Pressure settings in pressure switches should be adjustable at any point of time to any required rating.

Pumps shall be capable of furnishing not less than 150% of rated capacity at a head of not less than 65% of the rated head. The shut-off head shall not exceed 140% of rated head.

## **9.0 FIRE HYDRANT SYSTEM**

### 9.1 General

- a) Galvanized Iron Class “B” fire riser main within the building and as well outside the building.
- b) Landing valves, hose reels, hose cabinets, etc.
- c) All materials shall be of the best quality confirming to these specifications and subject to the approval of the Engineer-in-charge.
- d) Pipes shall be fixed in a manner as to provide easy accessibility for repair and maintenance and shall not cause obstruction in shafts, passages etc.,
- e) Pipes and fittings shall be fixed to walls and ceilings by suitable clamps at intervals specified. Only approved type of anchor fasteners shall be used for RCC ceiling and walls.
- f) Valves and other appurtenances shall be so located that they are easily accessible for operations repairs and maintenance.
- g) Joints in risers- All risers shall be installed with grooved couplings with necessary fittings .Horizontal & branch floor piping shall be screwed up to 50mm dia. and grooved joints for higher pipe sizes shall be used.

### 9.2 Hydrants Valves

ISSUE P0
-------------

SPEC. NO.	<b>TATA CONSULTING ENGINEERS LIMITED</b>	SECTION: C1
TCE.10477A-PP-6041-60540-P0	<b>SCOPE OF WORK &amp; SPECIFIC REQUIREMENT-MECHANICAL</b>	SHEET 15 OF 22

a) The Hydrants valve confirming to IS 5290 (Type “A”) shall have gun metal single outlet having 80 NB flanged inlet. Outlet shall be oblique female instantaneous type coupling having spring loaded lugs; internal parts shall be of copper or gunmetal. ABS plastic cap with chain shall be provided on the outlet of the valve etc.

b) The hydrant valve shall be ISI marked.

9.3 Orifice Plates

a) Contractor shall supply and installed orifice plate flanges on all hydrants having excessive pressure (more than 7 bar complete in all respects ), Orifice plates shall be fabricated from 6 mm thick stainless steel plates with plain central hole without burrs.

b) Orifice plate must have a projecting identification tag.

c) The orifice plate shall fitted not less than two pipe internal diameters down stream of the outlet from any elbow or brand.

d) The bore of the orifice shall be designed by the Contractor and calculations to be submitted to Owner/ consultant / Employer's Representative for approval.

9.4 Branch pipe and nozzle

a) Branch pipes shall be of gun metal with loaded ring at the discharge and to receive the nozzle and provided at the other with a leaded tin bronze ring ring to fit into the instantaneous coupling.

b) Nozzle shall be of spray type of diameter of 20mm. Nozzle shall be of loaded gun metal branch pipe and nozzle shall be of instantaneous pattern etc.

9.5 Reinforced Rubber-Lined (RRL) fire hose pipe with coupling

a) Rubber reinforced lined fire hose pipe (as per IS : 636) type-A of 63 mm dia and 15 meter.

b) The Fire Hose Pipe shall be rated for burst pressure of 37.5 kg/sq cm. Hose shall be complete with ISI marked brass male and female coupling (IS:903) bound and riveted to hose pipe with copper rivets and 1.5mm copper wire etc.

c) The fire hose as well as coupling shall be ISI marked.

9.6 Hose Cabinet

a) Hose cabinet shall be provided for all internal and external fire hydrants.

b) Hose cabinets shall be fabricated from SS 304 sheet of fully welded construction with hinged double front door partially glazed (4 mm glass panel) with locking arrangement.

ISSUE P0
-------------

SPEC. NO.	<b>TATA CONSULTING ENGINEERS LIMITED</b>	SECTION: C1
TCE.10477A-PP-6041-60540-P0	<b>SCOPE OF WORK &amp; SPECIFIC REQUIREMENT-MECHANICAL</b>	SHEET 16 OF 22

- c) Weather proof standard size of Fire Hose Cabinet shall be fabricated from 40 x 40 x 5 angle iron sections and 16 gauge MS sheet 750 mm x 600 mm x 250 mm having single or double opening glazed (3.0 mm thick glass) shutter including necessary locking arrangement by allan key, stove enamelled Fire red/PO red finish (as per site engineer approval and local CFO requirement) with " Fire Hose" marked on front, suitable for housing 2 nos. Hose pipe, 1 No. branch pipe . branch pipe with breaking Hammer, One Fire Extinguishers & box key.

9.7 First Aid Hose Reels

- d) Contractor shall supply and installed swinging type First Aid hose reel in fire red /PO red colour shall be used as per site engineer approval and local CFO requirement
- e) Hose reel drum thickness of 1.6mm with 30 mts long and 20 mm dia heavy duty rubber water hose, 20 mm dia gate valve stop cock, (IS:778, class - II) terminating with G.M. Coupling & nozzle of 6mm outlet with shut off valve confirming to IS 8090 complete with G.I socket for tap-off, drum and brackets (including painting) for installation on wall with anchor fastner, bolts & nuts conforming to IS:884.

9.8 Fire shaft

- a) Contractor shall supply and installed "J "type hooks supports made of 25 mm dia pipe to support 2 nos. 15 m long hoses and 01 No short branch pipe. Detailed drawing to be made & it must be GI/SS fixable on wall required anchor fastner, nuts, etc complete

9.9 Fire Brigade Inlet Connection (FBIC).

- a) The storage tank shall be provided with a gunmetal 4 way fire water tank inlet connection with 4 Nos 63 mm dia. built - in Non- return valves instantaneous coupling type arranged on 150 mm dia. Pipe with necessary wrapping coating /flanges /nutbolt /gasket and as per spec, butterfly valve and connected to Fire water tank as per specification.
- b) Tag shall be provided on the FBI, indicating the direction of the pipe and its purpose such as "FIRE BRIGADE INELET CONNECTION".

9.10 Draw Out Connection.

- a) The storage tank shall be provided with two way gunmetal suction collecting head as per IS: 904-1983, hose coupling (draw out connection) with female outlet as per IS 902 complete with 150mm dia. Suction pipe (with necessary wrapping coating /flanges /nutbolt /gasket and as per spec) with one butterfly valve, a foot valve with strainer of approved make complete in all respect. Tag to be added on the post including aluminium chain & PVC cap.

9.11 Air Vessel

ISSUE P0
-------------

SPEC. NO.	<b>TATA CONSULTING ENGINEERS LIMITED</b>	SECTION: C1
TCE.10477A-PP-6041-60540-P0	<b>SCOPE OF WORK &amp; SPECIFIC REQUIREMENT-MECHANICAL</b>	SHEET 17 OF 22

Contractor shall supply and installed precharged air vessel fabricated from 8 mm thick MS plate(size 450 mm dia & 1500 mm height) for pressurization of hydrant / sprinkler system complete with adequate pressure switches (as per design / requirement) with valves to operate as per operating sequences including 25 mm dia drain valve, air release valve with stop cock on the top, 25 mm dia inlet with isolating valve duly painted from inside and outside with two coats of synthetic enamel paint over a coat of primer complete as required. All air vessels shall be ultrasonic tested & hydrottested by authorised agency and the test certificates shall be provided.

#### 9.12 Air Release Valve

Contractor shall supply and installed 15 mm Air Release Valve-BRASS for risers, suitable for pressure not less than PN20. inclusive of FM approved ss ball valve and G.I barrel nipple inclusive of all items to complete satisfactory installation ,complete as per data sheet A of Air release valve.

#### 9.13 Pipes and Fittings

- a) All hydrant pipe headers/riser shall be worded indicating the direction of the flow and its purpose such as "TO RISER NO.1" as per site engineer /CFO requirement etc.
- b) Following pressure rating criteria to be followed while selecting the pipes,fittings ,valve and accessories .

Sr.No.	Description	Pressure Rating
1	Pipes in pump room.	PN 20
2	Riser from ground to terrace floor.	PN 16

### 10.0 **AUTOMATIC SPRINKLER SYSTEM**

#### 10.1 General

- a) Pipes fittings and support shall be the same as for Fire Hydrant System.
- b) Sprinklers and multiple controls installed in the sprinkler systems shall be suitable for the fire protection service. Sprinklers shall not be reconditioned or repaired. Used and/or defective sprinklers shall be replaced by new ones. However, the multiple control systems may be repaired or reconditioned but pressure testing shall be carried out before commissioning such installations.
- c) The sprinkler heads are of fixed temperature type with a quartzoid bulb containing liquid having high vapour pressure held in position by forged GM yoke and a deflector conforming to IS 15105.
- d) Contractor shall supply and installed 25 spare sprinkler heads and 2 nos. spanners neatly installed in a steel box with glass shutter at an appropriate position approved by the engineer-in-charge.

ISSUE P0
-------------



SPEC. NO.	<b>TATA CONSULTING ENGINEERS LIMITED</b>	SECTION: C1
TCE.10477A-PP-6041-60540-P0	<b>SCOPE OF WORK &amp; SPECIFIC REQUIREMENT-MECHANICAL</b>	SHEET 18 OF 22

10.2 Sprinkler (UL/FM approved)

- a) Sprinkler heads shall be of gunmetal quartzoid bulb type containing liquid having high vapor pressure held in position by forged GM yoke and deflector etc complete as per data sheet A of sprinkler.
- b) Contractor shall supply and installed Pendant type sprinkler of 15 NB, Quartzoid bulb type 68 deg.K 80 standard Response ,Coverage Area 12 sq.mtr, with adjustable escutcheon plate in SS 304 as per UL/FM Approved. It should be installed by teflon tape and lock tite solution etc.
- c) Contractor shall supply and installed upright type sprinkler of 15 NB, Quartzoid bulb type 68 deg.K factor 80 standard Response ,Coverage Area 12 sq.mtr , with adjustable escutcheon plate in SS 304 as per UL/FM Approved.It should be installed by teflon tape and lock tite solution etc.
- d) Contractor shall supply and installed Pendant type sprinkler of 15 NB, Quartzoid bulb type 95/143 deg.K 80 standard Response for kitchen area ,Coverage Area 12 sq.mtr , with adjustable escutcheon plate in SS 304 as per UL/FM Approved.It should be installed by teflon tape and lock tite solution etc.
- e) Contractor shall supply and installed extended Coverage Pendant sprinkler of 80 degree Celsius with escutcheon plate etc.

10.3 Corrugated / Breaded Type Flexible Sprinkler Pipe

Contractor shall supply and installed UL/FM approved corrugated / breaded type SS-304 flexible sprinkler pipe of 1500mm long with droplet for 13 kg/ sq. cm. working pressure with 1inch inner dia of flexible drope with 1/2" threaded inlet with reducer nipple, snap, clamp, T-bar bracket etc. with necessary fitting complete as required.

10.4 Installation Control Valve

- a) Installation control valve shall be measured by numbers and shall include upstream Butterfly Valve, Alarm Valve, Alarm Motor and Gong, Drain Valve, Test Valve, Drain Piping and all fittings including 2 Nos. pressure gauges required to complete the work
- b) Contractor shall supply and installed submit detailed shop drawings showing the exact location, details of installation of the valves/alarm
- c) Contractor shall supply and installed UL/FM approved Wet Automatic Alarm Control valve with, nut, bolts & gasket complete with pad locking arrangement, vertical wet alarm valve with hydraulic alarm motor & gong, 2 nos. pressure gauges as per manufacturer recommendation with 150 mm strainer , ball valves, 15 mm dia test valves, 50 mm dia drain valve with all necessary accessories as per specification.

10.5 Inspection And Test Valve Assembly

ISSUE P0
-------------

SPEC. NO.	<b>TATA CONSULTING ENGINEERS LIMITED</b>	SECTION: C1
TCE.10477A-PP-6041-60540-P0	<b>SCOPE OF WORK &amp; SPECIFIC REQUIREMENT- MECHANICAL</b>	SHEET 19 OF 22

- a) Contractor shall supply and installed UL/FM approved Inspectors test drain assembly complete with test bronze valve, bronze sight glass sectional drain valve, union with pressure gauge.

10.6 Air Release Valve

Contractor shall supply and installed 15 mm Air Release Valve-BRASS for risers, suitable for pressure not less than PN20. inclusive of FM approved ss ball valve and G.I barrel nipple inclusive of all items to complete satisfactory installation.

10.7 Flow Switch

- a) Contractor shall supply and installed UL/FM approved Electrically operated flow indicating switch (vane type) of following diameter with threaded connection with flexible full bore paddle & NO/NC contact terminals as specified complete with all accessories and necessary wiring.
- b) Approved make armoured control wires 1.5sqmm made of PVC insulated copper conductor, PVC sheathed,confirming to IS 1554 etc
- c) The terminal box shall be mounted over the paddle/ pipe through a connecting socket.
- d) Flow switch shall have a paddle made of flexible and sturdy material of the width to fit within the pipe bore.
- e) The Switch shall be potential free in either NO or NC position as required.
- f) The switch shall be able to trip and make / break contact on the operation of a single sprinkler head.
- g) The terminal box shall have connections for wiring to the Annunciation Panel.
- h) The flow switch shall have connections for wiring the seat shall be of S.S to the Annunciation Panel.
- i) The flow switch shall have IP: 55 protections.

10.8 Pipes For Drainage:

- a) Sprinkler pipes shall be so installed that the system can be thoroughly drained. As far as possible all pipes shall be arranged to drain to the installation drain valve.
- b) In the case of other areas where sprinkler pipe-work is below the installation drain valve & in other trapped points in the system, auxiliary valves of the following sizes shall be provided.
- 20 mm valves for pipes upto 50mm dia.
- 25 mm valves for 80mm dia pipe.

ISSUE P0
-------------

SPEC. NO.	<b>TATA CONSULTING ENGINEERS LIMITED</b>	SECTION: C1
TCE.10477A-PP-6041-60540-P0	<b>SCOPE OF WORK &amp; SPECIFIC REQUIREMENT-MECHANICAL</b>	SHEET 20 OF 22

-50 mm valves for pipes larger than 80mm dia.

#### 10.9 Pipes and Fittings

- a) All sprinkler pipe headers/riser shall be worded indicating the direction of the pipe and its purpose such as "TO RISER NO.1" as per site engineer /CFO requirement etc.
- b) Following pressure rating criteria to be followed while selecting the pipes, fittings, valve and accessories .

Sr.No.	Description	Pressure Rating
1	Pipes in pump room.	PN 20
2	Riser from ground to terrace floor.	PN 16

#### 11.0 **SIGNAGES**

11.1 Contractor shall supply and position the following type of sign boards made out of 3mm thick "Opaque" PVC foam board with computer cut, PVC non-reflective self adhesive vinyl painted foam board, complete with mirror fasteners.

- a) Signage with printed "IN CASE OF FIRE, USE STAIRS UNLESS INSTRUCTED OTHERWISE" OF 1.25 cm height letters in red with white back ground. The size of the board shall be 25cm x 30cm and shall be fixed at the height of 2 mts. From finished floor near Manual call points.
- b) Floor identification signage(ie., GROUND FLOOR.....etc) at each stair enclosure on every floor, indicating the floor number in words, lettering size shall be 7.5cm with contrasting colour from back ground. Size shall be 15cm x 60cm.
- c) Fire Signage for Fire Extinguishers
- d) Lift Signages
- e) Fire pump room display of drawing Electrical panel & Pump Flow drawing
- f) Fire escape plans of A3 sizes
- g) Flow direction & respective pipe description painting for hydrant system and sprinkler system.

#### 12.0 **GAS BASED FIRE SUPPRESSION SYSTEM FOR DATA CENTRE AND COMMAND AND CONTROL CENTER(CCC)**

##### 12.1. General

All the equipment of Fire Suppression System namely Cylinders, Nozzles, and accessories for completing the Fire Suppression system except piping and manifold shall be of one make only. Without compliance to the above clause, the tender would be cancelled.

ISSUE P0
-------------

SPEC. NO.	<b>TATA CONSULTING ENGINEERS LIMITED</b>	SECTION: C1
TCE.10477A-PP-6041-60540-P0	<b>SCOPE OF WORK &amp; SPECIFIC REQUIREMENT-MECHANICAL</b>	SHEET 21 OF 22

Following authorizations shall be made available from the manufacturer.

- a. Technical compliance to the specifications, this should be vetted by Manufacturer.
- b. Authorization for participating in the tender on manufacturer's behalf.
- c. Authorization for providing test reports complying the specifications at the time of inspection.
- d. Authorization that the items quoted by the tenderer are in production and would be serviceable for at-least 5 years from the date of tender. No obsolete products should be quoted.

Compliance to the standards for the products listed.

Letter from Manufacturer for supporting the system for at least 5 years

Manufacturer must have presence in India. Manufacturer products shall have quality system is in compliance with the international standards.

Initial fill & subsequent filling of Seamless Cylinders shall be done at UL & PESO approved filling station.

### **12.2. Specifications**

1. The Clean Agent system considered for Total flooding application

2. The minimum criterion for the selection of the Clean Agent will be on the following parameters

Zero Ozone Depleting Potential.

Global Warming Potential not exceeding one.

Atmospheric Lifetime not exceeding one week.

The clean agent fire suppression system with NOVEC 1230 are accepted critical areas

3. The Clean Agent considered for the suppression system must be suitable for manable occupied areas with high NOAEL (No observable adverse effect level) as compared to the design concentration to ensure high safety margin for the human who might be present in the hazard area.

4. The minimum design standards shall be as per NFPA 2001, 2004 edition or latest revisions.

5. For safety reasons the clean agent fire suppression system cylinder, valve, discharge hose, nozzles, fire detection detectors and panels etc. must be considered from the same manufacturer to ensure proper performance as a system with UL/FM approvals, thereby giving a

ISSUE P0
-------------

SPEC. NO.	<b>TATA CONSULTING ENGINEERS LIMITED</b>	SECTION: C1
TCE.10477A-PP-6041-60540-P0	<b>SCOPE OF WORK &amp; SPECIFIC REQUIREMENT-MECHANICAL</b>	SHEET 22 OF 22

confidence that a third party has tested the performance of the hardware. All components of the system shall be UL approved.

### **12.3. Fire Suppression System**

#### GENERAL

#### I. SCOPE

This specification outlines the requirements for a "Total Flood" Clean Agent Fire Suppression System integrated with existing automatic detection and control. The work described in this specification includes all engineering, labor, materials, equipment and service necessary, and required, to complete and test the suppression system.

#### II. Applicable Standards and Publications

A. The design, equipment, installation, testing and maintenance of the Clean Agent Suppression System shall be in accordance with the applicable requirements set forth in the latest edition of the following codes and standards:

##### 1. National Fire Protection Association (NFPA) Standards:

- NFPA 2001 Clean Agent Fire Extinguishing Systems
- NFPA 70 National Electric Code
- NFPA 72 National Fire Alarm Code

##### 2. Factory Mutual Systems (FM) Publications

- Factory Mutual Approval Guide

##### 3. Underwriters Laboratories, Inc. (UL) Publication

- Fire Protection Equipment Directory with quarterly supplements

##### 4. National Electrical Manufacturers Association (NEMA) Publication

- Enclosures for Industrial Controls and Systems

##### 5. U.S. Environmental Protection Agency, Protection of Stratospheric Ozone 59 FR 13044 (SNAP)

##### 6. Requirements of the Authority Having Jurisdiction (AHJ), State and Local codes in force at time of award of contract

ISSUE P0
-------------

SPEC. NO.	<b>TATA CONSULTING ENGINEERS LIMITED</b>	SECTION: C1
TCE.10477A-PP-6041-60540-P0	<b>SCOPE OF WORK &amp; SPECIFIC REQUIREMENT-MECHANICAL</b>	SHEET 23 OF 22

B. The standards listed, as well as all other applicable codes, standards, and good engineering practices, shall be used as —minimum" design standards.

### III. REQUIREMENTS

The Suppression System installation shall be detail out by the contractor for critical area i.e. Server room & Data Centre in accordance with guidelines with the drawings, specifications, and applicable standards.

Same shall be submit for approval to the Employer. The system engineering company will carry out the piping isometric design and validate the same with a hydraulic flow calculations generated by using UL approved software.

This include all 120 VAC or 220 VAC power supply to the system control panel, Interlock wiring and conduit for shutdown of HVAC, dampers and/or electric power supplies, relays or shunt trip breakers

### V. QUALITY ASSURANCE

#### A. MANUFACTURER

1. The manufacturer of the suppression system hardware and detection components shall be ISO 9001 registered.
2. The name of the manufacturer shall appear on all major components.
3. All devices, components, and equipment shall be the products of the same manufacturer, or supplied by the same manufacturer.
4. All devices, components, and equipment shall be new, standard products of the manufacturer's latest design and suitable to perform the functions intended.
5. All devices and equipment shall be UL listed.
6. Locks for all cabinets shall be keyed alike.

#### B. INSTALLER

1. The installing contractor shall be trained by the supplier to design, install, test, and maintain fire suppression systems.
2. When possible, the installing contractor shall employ a NICET certified special hazard designer, Level II or above, who will be responsible for this project.
3. The installing contractor shall be an experienced firm regularly engaged in the installation of automatic clean agent, or similar, fire suppression systems, in strict accordance with all applicable codes and standards.
4. The installing contractor must have a minimum of one (1) year experience in the design, installation, and testing, of clean agent, or similar

ISSUE P0
-------------

SPEC. NO.	<b>TATA CONSULTING ENGINEERS LIMITED</b>	SECTION: C1
TCE.10477A-PP-6041-60540-P0	<b>SCOPE OF WORK &amp; SPECIFIC REQUIREMENT-MECHANICAL</b>	SHEET 24 OF 22

fire suppression systems. A list of systems of a similar nature and scope shall be provided on request.

5. The installing contractor shall maintain, or have access to, a clean agent recharging station. The installing contractor shall provide proof of his ability to recharge the largest clean agent system within One Week after a discharge.

#### C. SUBMITTALS

1. The installing contractor shall submit the following design information and drawings for approval prior to starting work on this project:

a) Field installation layout drawings having a scale of not less than 1/8 in. = 1 ft.- 0 in. or 1:100 detailing the location of all agent storage tanks, nozzles, pipe runs, including pipe sizes and lengths, control panel(s), detectors, manual pull stations, abort stations, audible and visual alarms, etc.

b) Auxiliary details and information such as maintenance panels, door holders, special sealing requirements, and equipment shutdown.

c) Separate layouts, or drawings, shall be provided for each level, (i.e.; room, sub floor, and above ceiling) and for mechanical and electrical work.

d) Electrical layout drawings shall show the location of all devices and include point-to-point conduit runs and a description of the method(s) used for detector mounting.

e) Provide an internal control panel wiring diagram which shall include power supply requirements and field wiring termination points.

f) Separate drawing providing symbol legend and identifying all symbols used.

g) Annunciator wiring schematics and dimensioned display panel illustration shall be provided. (Optional device.)

h) Complete hydraulic flow calculations, from a UL listed computer program, shall be provided for all engineered clean agent systems. Calculation sheet(s) must include the manufacturer's name and UL listing number for verification. The individual sections of pipe and each fitting to be used, as shown on the isometrics, must be identified and included in the calculation. Total agent discharge time must be shown and detailed by zone.

i) A complete sequence of operation shall be submitted detailing all alarm devices, shutdown functions, remote signaling, damper operation, time delay, and agent discharge for each zone or system.

2. Submit drawings, calculations and system component sheets for approval to the PMC, Architect and Consultant for record.

ISSUE P0
-------------

SPEC. NO.	<b>TATA CONSULTING ENGINEERS LIMITED</b>	SECTION: C1
TCE.10477A-PP-6041-60540-P0	<b>SCOPE OF WORK &amp; SPECIFIC REQUIREMENT-MECHANICAL</b>	SHEET 25 OF 22

## 12.4. System Requirements

### I. System Description and Operation

A. The system shall be a Total Flood Fire Suppression System supplied by manufacturer's authorized distributor only.

B. The system shall provide a Novec 1230/FK1230 minimum design concentration of 4.2% by volume for Class A hazards and a minimum of 5.85% by volume for Class B hazards in all areas and/or protected spaces, at the minimum anticipated temperature within the protected area. System design shall not exceed 10% for normally occupied spaces, adjusted for maximum space temperature anticipated, with provisions for room evacuation before agent release.

C. The system shall be complete in all ways. It shall include a mechanical and electrical installation, all detection and control equipment, agent storage containers, Novec 1230 agent, discharge nozzles, pipe and fittings, manual release and abort stations, audible and visual alarm devices, auxiliary devices and controls, shutdowns, alarm interface, advisory signs, functional checkout and testing, training and any other operations necessary for a functional UL listed Clean Agent suppression system.

D. Provide two (2) inspections during the first year of service: Inspections shall be made at 6-month intervals commencing when the system is first placed into normal service.

E. The general interior contractor shall be responsible for sealing and securing the protected spaces against agent loss and/or leakage during the 10-minute "hold" period.

F. The system(s) shall be actuated by a combination of Photo thermal , Laser Bases early detection and photoelectric detectors installed for maximum area coverage of 250 sq. ft. (23.2 m) per detector, in both the room, under floor and above ceiling protected spaces. If the airflow is one air change per minute, photoelectric detectors only shall be installed for maximum area coverage of 125 sq. ft. (11.6 m) per detector. (Ref. NFPA No. 72.)

G. Detectors shall be Cross-Zoned detection requiring two detectors to be in alarm before release.

H. Automatic operation of each protected area shall be as follows:

1. Actuation of one (1) detector, within the system, shall:

- a) Illuminate the "ALARM" lamp on the control panel face.
- b) Energize an alarm bell.

ISSUE P0
-------------



SPEC. NO.	<b>TATA CONSULTING ENGINEERS LIMITED</b>	SECTION: C1
TCE.10477A-PP-6041-60540-P0	<b>SCOPE OF WORK &amp; SPECIFIC REQUIREMENT-MECHANICAL</b>	SHEET 26 OF 22

c) Transfer auxiliary contacts, which can perform auxiliary system functions such as: Operate door holder/closures on access doors; Transmit a signal to a fire alarm system; Shutdown HVAC equipment.

d) Light an individual lamp on an optional annunciator.

2. Actuation of a 2nd detector, within the system, shall:

a) Illuminate the "PRE-DISCHARGE" lamp on the control panel face.

b) Energize a pre-discharge horn/strobe device.

c) Shut down the HVAC system and/or close dampers.

d) Start time-delay sequence (not to exceed 60 seconds).

e) System abort sequence is enabled at this time.

f) Light an individual lamp on an optional annunciator.

3. After completion of the time-delay sequence, the Clean Agent system shall discharge and the following shall occur:

a) Illuminate a "SYSTEM FIRED" lamp on the control panel face.

b) Shutdown of all power to high-voltage equipment.

c) Energize a visual indicator(s) outside the hazard in which the discharge occurred.

d) Energize a "System Fired" audible device. (Optional)

4. The system shall be capable of being actuated by manual discharge devices located at each hazard exit. Operation of a manual device shall duplicate the sequence description above except that the time delay and abort functions shall be bypassed. The manual discharge station shall be of the electrical actuation type and shall be supervised at the main control panel.

## **12.5. Material and Equipment**

### **A. GENERAL REQUIREMENTS**

1. The Clean Agent system materials and equipment shall be standard products of the supplier's latest design and suitable to perform all functions intended. When one or more pieces of equipment must perform the same function(s), they shall be duplicates produced by one manufacturer.

2. All devices and equipment shall be U.L. Listed.

3. Each system shall have its own supply of clean agent.

4. The system design can be modular, central storage, or a combination of both design criteria.

5. Systems shall be designed in accordance with the manufacturer's guidelines.

ISSUE P0
-------------

SPEC. NO.	<b>TATA CONSULTING ENGINEERS LIMITED</b>	SECTION: C1
TCE.10477A-PP-6041-60540-P0	<b>SCOPE OF WORK &amp; SPECIFIC REQUIREMENT-MECHANICAL</b>	SHEET 27 OF 22

6. Each supply shall be located within the hazard area, or as near as possible, to reduce the amount of pipe and fittings required to install the system.

7. The clean agent shall be stored in Clean Agent storage tanks. Tanks shall be super-pressurized with dry nitrogen to an operating pressure of 360 psi @ 70 °F (24.8 bar at 21 °C). Tanks shall be of high-strength low alloy steel construction and conforming to NFPA 2001.

8. The clean agent shall be stored in cylinders designed to hold the agent at ambient temperature. UL listed seamless PESO approved cylinders shall be charged to a fill density as specified in the manufacturer's listed manual.

9. Tanks (master) shall be actuated by either a resettable electric actuator or by pneumatic means from a nitrogen cartridge located in the releasing device. Explosive devices shall not be permitted.

10. Each tank shall have a pressure gauge and low pressure switch (optional) to provide visual and electrical supervision of the container pressure. The low-pressure switch shall be wired to the control panel to provide audible and visual "Trouble" alarms in the event the container pressure drops below 290 psi (20 bar). The pressure gauge shall be color coded to provide an easy, visual indication of container pressure.

11. Tanks shall have a pressure relief provision that automatically operates before the internal nominal pressure exceeds 730 psi (50 bar).

12. Engineered discharge nozzles shall be provided within the manufacturer's guidelines to distribute the Novec 1230 agent throughout the protected spaces. The nozzles shall be designed to provide proper agent quantity and distribution. Nozzles shall be available in 1/2 in. through 2 in. pipe sizes. Each size shall be available in 180° and 360° distribution patterns.

12. Distribution piping and fittings shall be installed in accordance with the manufacturer's requirements, NFPA 2001, and approved piping standards and guidelines. All distribution piping shall be installed by qualified individuals using accepted practices and quality procedures. All piping shall be adequately supported and anchored at all directional changes and nozzle locations.

a) All piping shall be reamed, blown clear and swabbed with suitable solvents to remove burrs, mill varnish and cutting oils before assembly.

b) All pipe threads shall be sealed with Teflon tape pipe sealant applied to the male thread only.

c) All pipes shall be of ASTM-A-106 Gr. B Schedule-40 seamless pipes and fittings shall be as per ASTM-A-106/A-234 Standard.

ISSUE P0
-------------

SPEC. NO.	<b>TATA CONSULTING ENGINEERS LIMITED</b>	SECTION: C1
TCE.10477A-PP-6041-60540-P0	<b>SCOPE OF WORK &amp; SPECIFIC REQUIREMENT-MECHANICAL</b>	SHEET 28 OF 22

d) The thickness of the piping shall be calculated in accordance with ASME B31.1.

13. In case of discharge the system shall have the capability to be refilled within seven days.

14. The agent used in the system shall not have an atmospheric life time of more than 8 days.

15. The agent used in the system shall not have a Global Warming Potential of one.

16. The agent used in the system shall have Zero Ozone Depletion Potential.

**B. AGENT**

1. The fire suppression agent shall be 3M™ Novec™ 1230 Fire Protection Fluid manufactured by 3M Company, St. Paul, MN or their approved supplier.

2. Agent shall not contain any Hydrofluorocarbons (HFC).

**C. CAUTION and ADVISORY SIGNS**

Signs shall be provided to comply with NFPA 2001 and the recommendations of the gas suppression equipment provider.

1. Entrance sign: (1) required at each entrance to a protected space.

2. Manual discharge sign: (1) required at each manual release station.

3. Flashing light sign: (1) required at each flashing light over each exit from a protected space.

**12.6. Testing and Documentation**

**I. SYSTEM INSPECTION and CHECKOUT**

After the system installation has been completed, the entire system shall be checked out, inspected, and functionally tested by qualified, trained personnel, in accordance with the manufacturer's recommended procedures.

A. All containers and distribution piping shall be checked for proper mounting and installation.

B. All electrical wiring shall be tested for proper connection, continuity and resistance to earth.

C. The complete system shall be functionally tested, in the presence of the owner or his representative, and all functions, including system and equipment interlocks, must be operational at least five (5) days prior to the final acceptance tests.

ISSUE P0
-------------

SPEC. NO.	<b>TATA CONSULTING ENGINEERS LIMITED</b>	SECTION: C1
TCE.10477A-PP-6041-60540-P0	<b>SCOPE OF WORK &amp; SPECIFIC REQUIREMENT-MECHANICAL</b>	SHEET 29 OF 22

D. Each detector shall be tested in accordance with the manufacturer's recommended procedures and test values recorded.

E. All system and equipment interlocks, such as door release devices, audible and visual devices, equipment shutdowns, local and remote alarms, etc. shall function as required and designed.

F. Each control panel circuit shall be tested for trouble by inducing a trouble condition into the system.

## II. TRAINING REQUIREMENTS

Prior to final acceptance, the installing contractor shall provide operational training to each shift of the owner's personnel. Each training session shall include control panel operation, manual and (optional) abort functions, trouble procedures, supervisory procedures, auxiliary functions and emergency procedures.

## III. OPERATION and MAINTENANCE

Prior to final acceptance, the installing contractor shall provide three (3) complete operation and maintenance instruction manuals to the owner. All aspects of system operation and maintenance shall be detailed, including piping isometrics, wiring diagrams of all circuits, a written description of the system design, sequence of operation and drawing(s) illustrating control logic and equipment used in the system. Checklists and procedures for emergency situations, troubleshooting techniques, maintenance operations and procedures shall be included in the manual.

## IV. AS-BUILT DRAWINGS

Upon completion of each system, the installing contractor shall provide three (3) copies of system "AS-Built" drawings to the owner. The drawings shall show actual installation details including all equipment locations (ie., agent container(s), etc.), as well as piping routing details. Show all room or facilities modifications, including door and/or damper installations completed. One (1) copy of reproducible engineering drawings shall be provided reflecting all actual installation details.

## V. ACCEPTANCE TEST

A. At the time "AS-Built" drawings and maintenance/operations manuals are submitted, the installing contractor shall submit a "Test Plan" describing procedures to be used to test the control system(s). The Test Plan shall include a step-by-step description of all tests to be performed and shall indicate the type and location of test apparatus to be employed. The tests shall demonstrate that the operational and installation requirements of this specification have been met. All tests shall be conducted in the presence of the owner and shall not be conducted until the Test Plan has been approved.

ISSUE P0
-------------

SPEC. NO.	<b>TATA CONSULTING ENGINEERS LIMITED</b>	SECTION: C1
TCE.10477A-PP-6041-60540-P0	<b>SCOPE OF WORK &amp; SPECIFIC REQUIREMENT-MECHANICAL</b>	SHEET 30 OF 22

B. The tests shall demonstrate that the entire control system functions as designed and intended. All circuits shall be tested: automatic actuation and manual actuation, HVAC and power shutdowns, audible and visual alarm devices, and manual override of abort functions. Supervision of all panel circuits, including AC power and battery power supplies, shall be tested and qualified.

#### VI. SYSTEM INSPECTIONS

A. During the one-year warranty period, the installing contractor shall provide two (2) inspections of each system installed under this contract. The first inspection shall be at the six-month interval, and the second inspection at the 12-month interval. Inspections shall be conducted in accordance with the manufacturer's guidelines and the recommendations of NFPA 2001.

B. Documents certifying satisfactory system(s) inspection shall be submitted to the owner upon completion of each inspection.

#### VII. WARRANTY

All system components furnished and installed under this contract shall be warranted against defects in design, materials and workmanship for the full warranty period which is standard with the manufacturer, but in no case less than one (1) year from the date of system acceptance.

### **13.0 SUMMARY OF DATA TO BE FURNISHED ALONG WITH BID**

The BIDDER shall ensure the following documentation are prepared and submitted to PURCHASER along with the Bid:

#### 13.1 TECHNICAL BID

- a) All data sheet from of the tender specification shall be duly filled in.
- b) Performance curves/rating charts used for selection of equipment for all the systems shall be furnished along with the bid, with the duty points duly marked on them.
- c) Electrical load list indicating rating and quantity. Bidder is not allowed to change the motor rating in the event of order placement

#### 13.2 DETAILED ENGINEERING DOCUMENTS AFTER LOI

- a) The detailed engineering documents including sprinkler, hydrant piping layout drawings, Fire extinguishers layout, Pumphouse Piping layout drawings etc., Piping design on node point pressure calculation for sprinkler layouts, support drawings, equipment selection basis etc., Motor kW calculation and all details.

ISSUE P0
-------------

SPEC. NO.	<b>TATA CONSULTING ENGINEERS LIMITED</b>	SECTION: C1
TCE.10477A-PP-6041-60540-P0	<b>SCOPE OF WORK &amp; SPECIFIC REQUIREMENT-MECHANICAL</b>	SHEET 31 OF 22

- b) Quality Assurance Plan for each equipment & accessories.
- c) Any drawing detailed fabrication drawing which may be necessary for ring bending / fabrication etc.
- d) Any drawing which may be required to be modified / generated to suit the site condition .
- e) General arrangement drawings for hydrants, water monitors, pumps, diesel tank valves & specialties.
- f) Equipment GA drawings, pipe routings and cross-section drawings., equipment detail drawings, dyke enclosure detail drawing, shop drawings foundation, piping supports, data for all equipment in the system in Contractor's scope with loading details.
- g) Quality assurance plan.
- h) Purchase specifications / requisitions for bought out items.
- a) Procedure for installation, maintenance and operation manual for bought out items.
- b) Final documents Occupancy & NOC certificate from CFO authority

### 13.3 FINAL DOCUMENTS

- a) Operation and maintenance manuals.
- b) Quality assurance documentation specific for the project.
- c) Final as built documentation folder containing all drawings and technical data sheets for future reference.
- d) Final Documents should also have the below mentioned documents as per below requirement –( 6 Set of each )
- e) As built drawings incorporating field modifications, if any.
- f) CONTRACTOR shall mark-up completely and clearly one set of prints of piping drawings of OWNER/TCE with approved modifications/field-runs carried out at site.
- g) Radiographic report along with radiographs
- h) All NDT records
- i) All alignment protocols
- j) Pipeline hydrotest record.
- k) Quality assurance documentation specific for the project.
- l) Contractor shall also submit a complete set of approved as built drawings together with performance / rating curves / charts of the equipment, maintenance schedule and test certificates wherever applicable.

ISSUE P0
-------------

SPEC. NO.	<b>TATA CONSULTING ENGINEERS LIMITED</b>	SECTION: C1
TCE.10477A-PP-6041-60540-P0	<b>SCOPE OF WORK &amp; SPECIFIC REQUIREMENT-MECHANICAL</b>	SHEET 32 OF 22

SR. No.	Requirements
1	Commissioning Report (Commissioning report shall have all key performance indicators of the particular equipment.)
2	Training & SOP
3	No Due Certificate/NO Claim Certificates
4	Warranty Certificate
5	Signed copy of Snag List
6	As Built Drawing Soft copy (CD)
7	As Built Drawing Hard copy (6 Sets)
8	List of critical spares with its quotation
9	Operation and Troubleshooting manual
10	Test Certificates & list of safety interlocks with validation report
11	Project Handover
12	Signed copy of equipment buy-off sheet.

**14.0 SCHEDULE OF INSPECTION / TESTING AT SITE (TO BE WITNESSED BY PMC/GC/CLIENT)**

14.1 The schedule of tests indicated below is indicative and not exhaustive. CONTRACTOR to carry out any other tests at site as per directions of CLIENT.

SI No.	Name of the System/Equipment	Tests to be carried out at site
a.	Pumps	Performance Test
b.	All rotating equipment	Noise level and vibration level measurement
c.	Power consumption	For all equipment
d.	Pump control panel and logic	Operation test
e.	Piping (Sample)	Hydrostatic leak test, Wrapper coating thickness, Radiography
f.	Fire Hydrant (Sample)	Operation test

ISSUE  
P0

SI No.	Name of the System/Equipment	Tests to be carried out at site
g.	Alarm Valve / Installation Control Valve	Operation Test



**TECHNICAL SPECIFICATIONS - ELV SYSTEM /**  
**INTEGRATED-BMS**

## 1.0 SCOPE OF WORKS – ELV SYSTEM & I-BMS

The scope consists of design, engineering, built, supply, testing and commissioning at site, operations & maintenance of all ICT components for the period of 5 years after final acceptance testing of services at Integrated Command Control Centre (ICCC), Guwahati (Assam).

- a) **Network Cabling / Data Network** – Design, Supply, Installation, Testing & Commissioning (DSITC) of Data Network Cabling (Cat-6) at all Data Touch Points, Work-Stations at ICCC building at Guwahati.
- b) **Fire Detection Alarm System (FDAS)** - Design, Supply, Installation, Testing & Commissioning (DSITC) of FDASS for entire building blocks and floors of ICCC Building at Guwahati.
- c) **Public Address System (PAS) / Ceiling Speakers** - Design, Supply, Installation Testing & Commissioning (DSITC) of PAS / Ceiling Speakers System for entire building blocks and floors of ICCC Building at Guwahati.
- d) **CCTV Surveillance System** - Design, Supply, Installation, Testing & Commissioning (DSITC) of CCTV Camera System for entire building entry and exit points and floors corridors of ICCC Building at Guwahati.
- e) **Access Control System (ACS) / Biometric System** - Design, Supply, Installation, Testing & Commissioning (DSITC) of Access Control System for the Data Server Farm Room, Record Room, Network Room and Critical Locations in ICCC Building.
- f) **Integrated Building Management System (IBMS)**, - Design, Supply, Installation, Testing & Commissioning (DSITC) of Integrated Building management System for building sub-systems and services of ICCC Building at Guwahati.
- g) **Projector with Motorised Screen and Microphone & Speaker System** - Supply, Installation, Testing & Commissioning (SITC) of Projector, Motorized Screen, Conference room Microphone & Speaker System for the Conference Rooms in ICCC Buildings.

## 2.0 NETWORK CABLING & DATA NETWORK

Data network cabling is new installations of building telecommunications wiring for the transport of voice, data, video, etc. and must meet or exceed the minimum ICCC requirements in cost effective manners as specified in this document.

All works that include all new ICT cabling shall:

- a) Be installed to comply with this Standard

- b) Have a minimum twenty (20) year performance warranty
- c) Have a minimum two (2) year installation warranty
- d) Be installed using a Ministry approved manufacturers product
- e) Have all relevant documentation submitted to the Integrated Command Control Centre (ICCC), Guwahati (Assam). and related Govt. body.

Some processes, methods, and procedures, as well as specifications, rooms size and structure, may be abbreviated or used interchangeably within the guidelines. The following list of terms as used in this section shall be defined as follows:

## 2.1 Structured Cabling System (SCS)

A SCS is defined as all required cabling including hardware, termination blocks, cross connect wire or cordage, patch panels, patch cords, telecommunication outlets, work area cords, UTP and fibre optic cable installed and configured to provide data and voice connectivity from each data or voice device to the network file server or voice network/switch designated as the service point of the local area network.

1. **Telecommunications Space (TS) / ICT Control Room-** A space dedicated for the exclusive propose to house telecommunications cabling and equipment. With ICCC approval physical security and distributed TV systems can be housed in this space.
2. **Main Distribution Frame (MDF)** - Environmentally controlled Telecom Space (TS) that is the primary point of interconnection between the communication facility provided by the public switched telephone company network and the building's communications facility. Housing the copper and fibre backbone main distribution frame. This space may also service an area of the building as an IDF.
3. **Intermediate Distribution Frame (IDF)** - This room is the Telecommunications Structured Cabling distribution point for an assigned area of the building.
4. **Horizontal Distribution (Link) Cabling** - The telecommunications cable routed between the IDF and a work area outlet. Horizontal distribution cables will be 4-pair Category 6, unshielded twisted pair (UTP) cable.
5. **Work Area Outlet (WAO)** - The workstation end-point of the drop, or horizontal distribution cable.

6. **ICCC Backbone** - The ICCC backbone links the MDF to each IDF. It consists of the backbone transmission media (copper and fibre optic cabling) between these locations and the associated connecting hardware terminating this media.

## **2.2 Referenced codes, Standards and Guidelines**

The SCS design shall be in accordance with the following published codes, standards and tests. The SCS design must be compliance GRIHA and other agencies applicable in Assam.

- a) Telecommunications Industry Association (TIA) standards
- b) American National Standards ICCC (ANSI)
- c) Electrical and Electronic Engineers (IEEE)
- d) ISO/IEC TR 14763-2-1: International Network Cable Labelling Standard
- e) ANSI/TIA/EIA-606-A Addendum 1: General Cable Plant Labelling Standard
- f) ANSI/TIA-606-B: Data Centre Specific Cable Plant Labelling Standard

## **2.3 Associated systems and components**

The following systems and peripheral components should be considered in conjunction with the design and implementation of the cabling system:

- a) False floor in server/communications rooms to facilitate cable routing to floor mounted racks and cabinets.
- b) Smoke detection in server and communications rooms
- c) UPS system capacity requirements, accommodation, battery maintenance and life span
- d) Wireless LAN / Access Points
- e) IP Telephone Systems
- f) Normal Telephone Trunk Lines.
- g) Video Conferencing System

- h) IP cameras (CCTV Surveillance) using existing switching (not on separate security network)
- i) Network for Data Communication (DCN) terminations and associated equipment. The SCS provides the physical media for the Project's Local Area Network (LAN) port and Wireless LAN and as such, provides connectivity for:
  - Data and voice devices
  - Wireless Local Area Network (WLAN)
  - Wireless Internet
  - IP Video Surveillance Cameras

The conceptual arrangement of a generic cabling system is illustrated below:

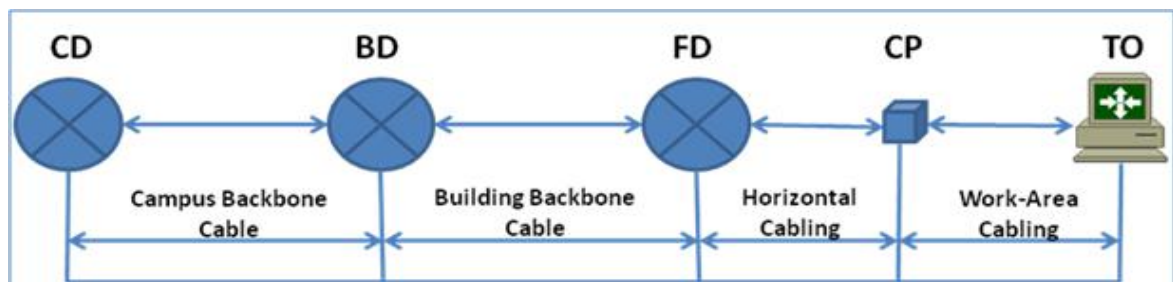

**Figure 1: Cable Distribution System (Data NW)**

The distributors (Campus Distributer-CD, Building Distributer-BD, and Floor Distributer-FD) provide the means to construct different cabling system topologies such as bus, star and ring, or a combination of these. Furthermore, the distributor functions may be combined, and the Consolidation Point (CP) may or may not be included in the cabling between the Telecommunications Outlet (TO) and the distributor.

## 2.4 Cabling Pathway

The data network provides interconnection between telecommunications rooms, equipment rooms, access points (AP) spaces and entrance facilities. The pathway is designing to route and manage copper data cables, fibre optic cables, and power cables within connected buildings

- These primary horizontal cabling pathways should be routed following building lines and major floor access routes such as corridors and hallways.
- They should never cross over end user work areas such as offices, conference rooms, or work cube areas.
- Access for cabling personnel and technicians that is enough for easy cable placement yet causes minimal disruption to floor occupants is an important design consideration when laying out the routing of primary horizontal cabling pathway.
- The vendor expected to minimise the use of exposed conduit and capping and overhead connections. Where possible all cabling and cable pathways, including

pits and external conduits, should be placed as unobtrusively as possible to be hidden from view and not attract attention. It is expected that where service pathways are provided in ICCC campus (walkway cavities are a perfect example), they will be used to distribute ICT Cabling Infrastructure around that campus – If for any reason this may not be practicable, then written agreement from both the ICCC authorised representative and the project implementation authority will be needed.

## **2.5 Fixings**

Fixings shall be entirely suitable for the situation in which they will be used:

- a) Where fixings are to be used externally or exposed to the weather stainless steel / HDPE shall be used. Plain and cadmium plated steel is not acceptable
- b) Where fixings are used internally, cadmium plated steel is acceptable.
- c) All fixings, fastenings and supports shall be of adequate strength and size and arranged to avoid mechanical failure under normal conditions prevailing in ICCCs.
- d) Cables shall be held firmly by the securing device without undue pressure being exerted on the cable sheaths.
- e) Cable ties used externally shall be UV resistant. The use of plastic cable ties shall not be permitted even for temporary fastening or support of cables during the construction phase.
- f) All cables shall be tied to catenaries and any other pathway or cabling loom using Velcro ties raps.

## **2.6 Internal-Building Standards & Methods**

- a) A main cable route shall be chosen such that the cable path is accessible and conforms to the segregation requirements
- b) Horizontal cabling and backbone cabling shall be installed on separate catenaries' wires
- c) The catenaries wire shall be anchored at a maximum of 3m spans. Turnbuckles and steel eyelets shall be used to tighten the catenaries so that there is no more than 150 mm sag between catenaries supports when fully loaded
- d) Any cable leaving the wire shall not have an unsupported length greater than one metre before its next fixing, access, or dropping down a wall

## **2.7 Data Cable – Type, Application & Performance**

ICCC Network cables, minimum standard for new horizontal cabling installations is based on using Cat 6 cabling components to provide a Class E infrastructure (Cat-6) performance which is guaranteed to transport Gigabit Ethernet (GbE) and allow for emerging technologies as they develop.

ICCC minimum standard for new backbone cabling installations is based on using OM3 optical fibre cable or short lengths of Cat 6e UTP (up to 40 m channel length). IEEE standards have been ratified for 10 Gigabit Ethernet (10GbE) on OM3 optical fibre and it is likely that backbone infrastructure will be required to support 10GbE transmission in the foreseeable future.

The defined optical fibre types are OM1, OM2, OM3 and OS1. The M in this case signifies multimode while the S signifies single-mode.

- ICCC shall be deploying the Cat-6 cable in entire communication for data access.
- All Network cabling for data network and voice network (IP-Telephony) must be the category of CAT 6e cables.
- All terminations shall be done to T-568A scheme.
- All cables must be pulled through HDPE ducts/conduits of minimum size of 30mm and maximum size of duct not more than 50 mm in building wiring. It shall be not visible in any case and all covered in conduits and ducts.
- No splices or joints in telecommunications cabling in access network.
- The use of ty-wraps is to be avoided. Hook and loop ties are preferred.

## **2.8 Work Area Outlets Layout**

Work Area Outlet (WAO) components extend from the telecommunications outlet/connector end of the horizontal cabling system to the WA equipment. A minimum of two telecommunications outlets (permanent links) should be provided for each work area.

## **2.9 Telephone Cables Wiring**

- Cable shall be made up of color coded, polyvinyl chloride insulated, solid annealed copper conductors with an overall polyvinyl chloride jacket.
- Direct splicing of cable will not be permitted. All splicing and terminating of cable shall be accomplished with plugs and connectors or connecting blocks as applicable.

## **2.10 Video Monitoring Room, Cabins, WorkStations and Server Rooms**

- Standard 4 ports faceplate is used.
- The use of other type or colour faceplates will be determined on a case by case basis and shall have prior approval from ICCC.
- ICCC has standardized on the colours of the jacks
  - All Cat-6 data jacks are to be yellow.
  - S special circuit's jacks must not be yellow, blue, or orange.



**Figure 2: Quad Outlets**

### **2.11 Conference Rooms**

- The vendor will need to consult with ICCC's Engineering Services Consultant for design specifications for Conference Rooms.
- Each conference room shall have a minimum of two WAO on opposite walls consisting of four CAT6 and one CATV cable.
- Consideration should be given to floor mounted WAO under conference table for data, voice and multi-media to projector with motorized screen.

### **2.12 Break Rooms, Lobby / Others**

- As a general rule, each break room area should have two walls mounted WAO
- Lobbies and corridors may have desk IP-Phones.
- Locate courtesy phones near elevators and or near main entrances /exits.

### **2.13 Modular Furniture**

- Telecommunications and Power distribution planning should be coordinated to avoid conflicting pathway assignments.
- Untried distribution or terminations strategies should be avoided.
- Permanent cables shall be installed only in or on permanent walls.



- All modular furniture shall be fed from a “Consolidation Point” (CP) and Work Area Outlet (WAO).
- Locate CP in an accessible area free from workstations and heavy file cabinets.
- Do not block access to horizontal cabling pathways or outlets.
- No cabling or WAO allowed behind modular furniture.
- Label “Consolidation Point” with adhesive label on ceiling grid where the CP is installed.

#### **2.14 Cabling Certification & Documentation**

ICCC requires the newly installed infrastructure to be tested and certified. Follow the Standards of ANSI/TIA/EIA-568-C.1,2,3,4 for testing criteria of the permanent link.

- Testing shall commence only after all materials are permanently installed, adjusted, bonded and labelled.
- Installer must retest and save both the original and retested results when any of the above occurs.
- Testing shall commence only in a clean environment, free of moisture, dirt, dust, and debris.
- Terminations exposed to such environments after testing will require retesting.
- Installers shall be certified by the manufacturer of the system(s) they are installing and be able to certify the installation for the manufacturer’s warranty.
- During testing, WAO and patch panel labelling must be verified.

#### **2.15 Testing Results**

Follow the manufacturer’s warranty submittals and submit a copy of all results (including Telephone wire, Fibre Optics, and Grounding/Bonding) to ICCC before final certification (see below).

- All UTP cable test results must be submitted in their original format from tester in electronic format.
- Telephone signal loss and attenuation, length, signal leakage report and documentation via spreadsheet.
- Fibre lengths, attenuation, OTDR trace, submit in their original format from tester.
- Tests must pass manufacturer’s specifications as well as industry standards.
- Cables with visible defects and deformations such as, kinks, twists or crushed will need to be replaced regardless of test results.

#### **2.16 Results and As-Built Drawings**

- Provide all test results and As-Built drawings at the time of project completion, both in hard and electronic versions to Facilities Services.
- Electronic copies of test results should be in PDF format.
- Drawings should be in a Visio compatible format.
- A courtesy copy of all documents should be provided directly to ICCG

## 2.17 Installation Labelling Requirements

Network cable labelling is like ensuring everyone involved in your network speaks the same language and anyone who comes in to augment or service your network can easily understand the architecture. It has become more important to accurately document every outlet and every port, so the information can be retrieving any time. List of blocks, conduits, trays, backbone cables, grounding, and racks shall be labelled as per standard operating procedures.

The key factor of a good administration system is the component labelling. Records cannot be established and maintained without good labelling during and after installation.

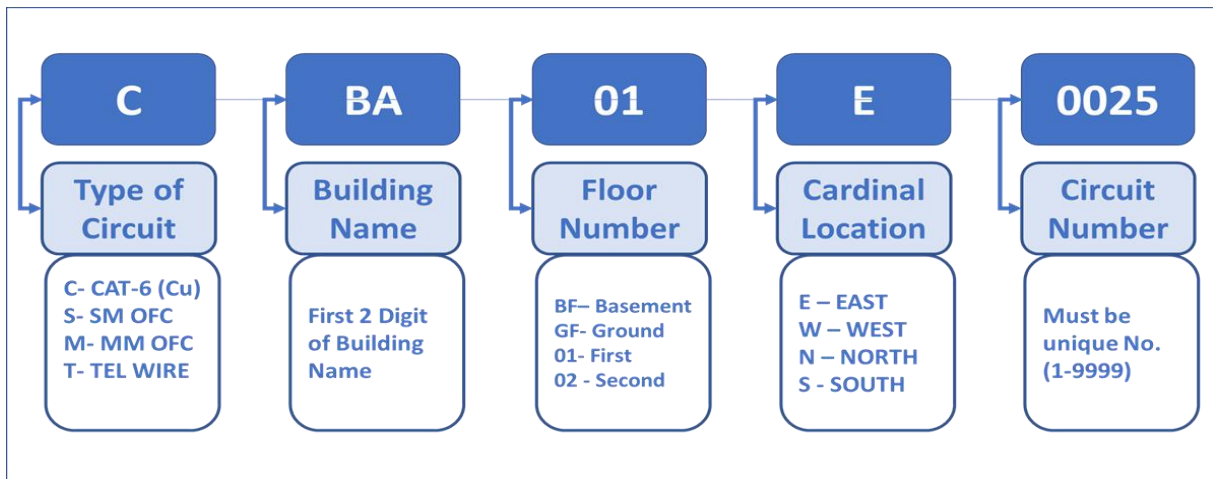

## 2.18 Specifications of Data Networking & Switching Equipment

### A. NETWORK CABLING & ACCESSORIES

SN.	Item	Required Parameter	Compliance (Y/N)	Remarks
-----	------	--------------------	------------------	---------

SN.	Item	Required Parameter	Compliance (Y/N)	Remarks
1	CAT6 UTP Cable	Category: 6 U/UTP Solid cable		
		Conductor: Copper (Solid)		
		Transmission Frequency: 250 MHz (minimum)		
		Should be 4 pair with cross separator		
		Cable should be 23 AWG copper conductor		
		Jacket: LSZH		
2	CAT6 UTP Information Outlet	It should be universal RJ45 type.		
		Category 6, EIA/TIA 568-C.2		
		information outlets Should accept cables from 22-24 AWG copper		
		Should be PCB free and Tool less		
		Material: Halogen Free		
		Should support 950 mating cycles		
		Jack should be optimized for 4PpoE (IEEE 802.3bt)		
		Should support 10GBase-T applications in acc. with IEEE 802.3an up to 500 MHz and 55 m		
		Should be Certified by independent labs like ETL/GHMT/3P/GL for compliance		
3	CAT6, 24-port unloaded Modular Straight Jack Panel- 1U	Should Be made of sheet steel 1.5 mm		
		Should be 19" 1U straight Patch Panel, 24-port		
		Should have integral cable management Metal shelf.		
		Should accept Shielded as well as Unshielded jacks		
		Should have rear cable management shelf metallic.		

SN.	Item	Required Parameter	Compliance (Y/N)	Remarks
		Jack panel should have option to accept different color snap in coding clips		
		Jack panel should have zig zag jack placement.		
4	Face Plate Duplex	Configured to fit standard gang outlet box		
		Square plate, 86mmx86mm		
		Write on labels in transparent plastic window – supplied with plate		
		Material: ABS Plastic		
		Face plate should have option to attach Hinged dust cover in different colors		
		Face Plate dust cover should be replaceable without removing patch cord		
5	CAT 6 Patch Cord- (1, 2 and 3 Mtr)	Should be Compliant with Cat.6 requirements of ISO/IEC 11801, EN 50173, EN 50168 and EIA/TIA 568.C.2		
		The Outer Jacket should be LSZH		
		Should be terminated using IDC technology		
		Patch cord should be optimized for 4P PoE (IEEE 802.3bt)		
		Should be unshielded		
		Patch cord should be terminated using insulation displacement connections		
		Option for different coding clips should be available		
		Same Patch cords should be able to accept locking arrangement in future		
6	UTP Field	Connection type: Toolless IDC Type		

SN.	Item	Required Parameter	Compliance (Y/N)	Remarks
	Termination Connector IP20 for Access Points	Category :6e UTP (Should not have metal shielding)		
		IP Class: IP 20 rated		
		Should be UL Listed		
		Should have color coded rings option		

#### A. HDPE DUCT PARAMETERS

SN	HDPE DUCT		Compliance (Y/N)	Product Documentation Reference
	Features	Minimum Configuration Requirements		
1	ISI Standards	1. IS: 4984 - 1995 - Specification for High Density Polyethylene Pipes for Water Supplies. 2. IS: 7328 - 1992 - High-density polyethylene materials for moulding and extrusion. 3. IS: 2530 - 1963 - Methods for Tests for polyethylene moulding materials and polyethylene compounds. 4. ASTM: D-638, Type-IV Specimens 6993 - Test Method for Environmental Stress-Cracking Ethylene Plastics.		
2	Size	40 mm outer dia & 32 mm internal dia		
3	Service Life	50 Years		
4	Colour	Orange & Yellow		

SN	HDPE DUCT		Compliance (Y/N)	Product Documentation Reference
	Features	Minimum Configuration Requirements		
5	Materials	The material used in the manufacture of ducts shall contain suitable UV-Stabilizers in required proportions such that ultra violet rays do not affect the ducts		

### B. PATCH PANEL (LIU) PARAMETERS

SN	PATCH PANNEL (LIU) & CONNECTOR		Compliance (Y/N)	Product Documentation Reference
	Features	Minimum Configuration Requirements		
1	Mating Cycle	1000		
2	Ferrule Size	2.5 mm Ceramic		
3	Typical Insertion Loss	0.25 - 0.30 dB		
4	IEC Specification	61754-4		

### C. TELEPHONE WIRES

SN	TELEPHONE WIRE (COPPER)		Compliance (Y/N)	Ref. Doc.
	Features	Minimum Configuration		
1	No. of Pairs	2 Pair		
2	Conductor Material	Copper		
3	Colour	Grey		
4	Nominal Area of Conductor	0.5 sq mm		
5	Max. Overall Diameter	0.50 sq mm		
6	Nom. Insulation Thickness	0.2 mm		
7	Resistance (Max.) per Km at 20° C	92.2 ohms		

SN	TELEPHONE WIRE (COPPER)		Compliance (Y/N)	Ref. Doc.
	Features	Minimum Configuration		
8	Insulation	High Density Polyethylene		
9	Rip Cord	Nylon		
10	Certification	BIS		

### 3.0 FIRE DETECTION & ALARM SYSTEM (FDAS)

#### 3.1 General Requirements

The fire detection and alarm system may comprise of main fire alarm control panels, optical smoke/heat sensors, heat sensors, and optical smoke/heat sensor with integral sounder units, manual call points, electronic sounders, repeat panels, and interface units, each with its own short circuit built-in isolators. All loop cabling and any other components and accessories deemed necessary for a safe, reliable and satisfactory system will conform to the relevant and applicable requirements and recommendations. The fire alarm system shall comply with requirements of NFPA standard No. 72 for protected premises signalling systems except as modified and supplemented by this specification. The system shall be electrically supervised and monitor the integrity of all conductors.

- Contractor will train and instruct client's personnel in the correct use, operation and supervision of the system, prior to the handing over of the project.
- The system will be fully programmed to accommodate at least **4** fire zones. The system will be configured to allow on site modifications with the minimum of disruption using the PC based software to facilitate future changes or alterations to the buildings.

#### 3.2 Code & Standards

All equipment, systems and works covered under this specification shall comply with all currently applicable statutes, regulations, standards and safety codes in the locality where the equipment shall be installed. The FDAS system shall comply with NFPA 72 & IS 2189 (2008) for all application.

In particular, the following standards are applicable

BIS:	Bureau of Indian Standards (IS:2189)
NFPA:	National Fire Protection Association
IEC:	International Electro technical Commission
NEC:	National Electric Code
NEMA:	National Electrical Manufacturer's Association
NBC:	National Building Code

Other national standards established to be equivalent or superior to the codes and standards specified are also acceptable.

Unless indicated otherwise, all codes and standards referred to in this enquiry specification shall be understood to be the latest version on the date of offer made by the Bidder.

#### **Mandatory Approvals**

- UL/ VdS listing
- FM approval

### **3.3 Fire Detection & Alarm System Components**

The Fire Detection and Alarm system comprises of the following:

- a) Addressable Multi Criteria detectors
- b) Addressable Heat detectors
- c) Flush Mount Detectors
- d) Loop Powered Sounders cum strobe
- e) Addressable Manual call points
- f) Addressable Conventional Zone Module
- g) Addressable Control module
- h) Beam Detector
- i) Aspiration Detector
- j) FDAS panel
- k) Cabling for FDAS
- l) I/O Modules
- m) Auto-Dialer
- n) Telephone Jack/Handset



All detectors and Manual call points shall be identified with a point address.

### **3.4 General Fire Alarm System Descriptions**

- 1) Fire detection and Alarm System shall consist of Fire Alarm Control Panels, various types of equipment's like Detectors, hooters, Strobes, monitor & control modules, Repeater panel, and different types of cables located at various strategic locations of the building.
- 2) In case of a Fire alarm initiation by an alarm initiating device, the audio-visual fire alarm shall be generated at the respective Fire Alarm Control Panels and at Repeater panel located in the Control Room, various location and initiate signal to operate hooters located in various locations.
- 3) All types of addressable detectors / interface units shall be compatible with the fire alarm panel.
- 4) All the alarm initiating devices that are asked for to be self-addressable type shall be of self-addressable type. In case of non-addressable detectors, the detector status shall be monitored through a Conventional Zone Interface Module (CZIM) to send the analogue information available from the detector to FACP. The BIDDER shall clearly indicate what are all the device / detectors which are not self-addressable in type and shall include CZIM module to make that device / detector addressable. The CZIM module cost shall also be considered as included in the detector cost
- 5) The detector shall be suitable to connect to the control unit via a four-wire circuit (Class –A wiring) as per NFPA.
- 6) The Fire Alarm System envisaged for this Building is “2-Wire Analog Addressable” type.
- 7) The communication between detectors and the FACP is by means of digital communication over 2-wire, which further provides power to the detectors, devices & Sounders. There shall be A/D and D/A conversion happening inside the detectors and FACP.
- 8) All the detectors shall be incorporated with microprocessors and shall be provided with Analog to Digital Converter (ADC), which enables the detector to provide linear output corresponding to the quantity of smoke or fire, the detector encounter.
- 9) All types of detectors offered will be of restorable type i.e. suitable for operating afresh after each actuation on alarm without replacement or adjustment.
- 10) The sensitivity of each sensor shall be individually adjusted from the FACP to suit the conditions of each location. Each detector shall have self-test facility, which is monitored in the FACP. Each detector shall have drift compensation.
- 11) The response sensitivity shall also be field adjustable and not only from fire panel

over a wide range to suit site conditions. It shall be possible to test the sensitivity of a detector in the field. The sensitivity / threshold value of detectors which are cross zoned must be compatible.

- 12) The FACP shall also check each sensor for contamination of dust/dirt and give signal for "Service" in case of accumulation of dust/dirt reaches a pre-set limit.
- 13) The fire alarm system shall work without any problem both in networked mode and in standalone mode.
- 14) The electronic circuit shall be of solid state and of failsafe design and virtually hermetically sealed to have resistance to humidity and corrosion and to prevent its operation from being impaired by dust and dirt.
- 15) The circuit shall be protected against usual electrical transients, electromagnetic and electrostatic interference (EMI & RFI) present in the Building.
- 16) Reverse polarity or fault in the field wiring shall not damage the detector.
- 17) No moving parts subject to wear & tear shall be provided.
- 18) All types of detectors & devices offered shall have an inbuilt fault isolator. The fire detectors shall be plug in type. Suitable locking device shall be supplied along with each detector. It shall be inserted into or removed from the standard base by simple push twist mechanism to facilitate easy exchange / cleaning and maintenance.
- 19) The system shall have following self-diagnostic features:
  - i. Detector cabling shall be completely supervised for open circuit and short circuit and exact location of fault shall be displayed in the panel under Trouble/Faults.
  - ii. Un-authorized removal of a detector head from its base shall be supervised to give an alarm on the connected control panel.
  - iii. Annunciation shall be provided for DC fuse blown and loss of main AC supply etc.
  - iv. Alarm verification features.

### 3.5 Fire Detection & Alarm System Specifications

#### 3.5.1 Analogue Addressable Fire Alarm Control Panel (FACP)

The FACPs used in the Building shall confine to the EN54 standards having the following features

S. No.	Technical Requirement	Compliance Yes/No	Remarks
--------	-----------------------	-------------------	---------

S. No.	Technical Requirement	Compliance Yes/No	Remarks
1	All the FACP's provided shall have the capacity to expand from 1 to 32 loops for Future expansion		
2	Each loop shall accommodate maximum 250 detectors and devices in any combination with a loop length capable up to 1.6 kms with 2C x 1.5 sq. mm cable		
3	FACP will function as fully stand-alone panel & also networked to other FACP's with peer to peer communication		
4	Each FACP shall have a possibility of accommodating redundant controller to takeover in case of a Failure in the Primary Controller and also redundant loop card for each loop to takeover in case of a Failure in the Primary Loop Card.		
5	Each FACP shall have inbuilt LCD colour touch screen (320*240 pixels) to clearly indicate the location of fire, type of device activated other indications like service requirement of a component, etc.		
6	In case of a Loop Card Failure, the FACP shall allow to replace the Loop card without switching off the panel and reprogramming.		
7	The FACP shall be of seamless integrated with PA use of RS232 module FA & PA both systems shall be of same make		
8	FACP's shall have inbuilt buzzer to alert the personnel in case of maintenance requirement		
9	ACP shall be programmed for sequence of events to happen in case of fire like closing of fire dampers, shutting down supply fans for HVAC, Deactivating the access control system and activating the hooters with the help of a control relay module provided near the system to be activated.		

S. No.	Technical Requirement	Compliance Yes/No	Remarks
10	All the fire alarm modules (loop cards, networking cards, and communication card. Etc.) Should be hot pluggable and hot swappable to facilitate easy replacement of faulty modules. All the electronic components shall be compatible to non-air-conditioned environment for working satisfactorily		
11	The FACP shall have an ingress protection of at least IP – 30		
12	It shall be capable of being surface, semi-flush or fully flush mounted with additional bezel. The fully flush bezels shall be painted to specification, stainless steel or brass as required.		
13	FACP shall mount in wall		
14	All the wiring shall be done using ferrules having indelible marking		
15	The FACP shall have a processor, which shall be of at-least 32 bits, which shall be designed to accept all the inputs and process the outputs within the time stipulated by the standards.		
16	A redundant CPU shall be provided with the same configuration which shall be made as hot standby – in case of failure of the main CPU, the standby shall takeover without interrupting the system		
17	The CPU shall have the facility to communicate with other FACPs and process the fire signals received from other FACPs to actuate a third-party device		
18	capacity of the processor shall be adequately designed include all input / output signals and various functional requirements		
19	It shall have its own, built in advanced microprocessor, sophisticated software and extensive memory for storing the logs of alarms, times and action taken report.		

### 3.5.2 Loop Modules

S. No.	Technical Requirement	Compliance Yes/No	Remarks
1	The loop module shall have a microprocessor inbuilt & shall be capable of handling 250 detectors and devices in any combination		
2	It shall have a line length up to 1600m or 3000m depending upon the configuration & cable type		
3	The loop module shall be encapsulated & shall be hot pluggable.		
4	In case of the failure of loop card, it should be replaced without the need of any additional programming.		

### 3.5.3 Intelligent Addressable Optical Smoke/ Heat (Multi Criteria Sensor) Detector

S. No	Technical Requirement	Compliance Yes/No	Remarks
1	The Intelligent Addressable Multisensory Detector used in this Building shall confine to the relevant standards having the following features		
2	It shall be combination of Smoke detection and heat detection. The smoke detection system shall work on Light scattering type principle using Infrared and the Heat detection system shall be of Rate of rise of temperature and Fixed Temperature.		
3	The Intelligent Addressable Multisensor Detector shall be of Spot type and Addressable type		

S. No	Technical Requirement	Compliance Yes/No	Remarks
4	The Intelligent Addressable Multisensor Detector shall be addressed either by DIP switches or through Programming from the Panel		
5	The Detector shall monitor EMC/EMI values in the surroundings on a continuous basis and report the current & average values to the panel. The detector and the panel shall together avoid the possibility of false alarm caused due to interferences from sources such as Motors, power cables, Wi-Fi routers, fluorescent lamps, network switches, mobile signals...etc.		
6	All the detectors shall have a visible multi-colour LED to indicate the healthiness / trouble / alarm condition of the detector. The LED shall be located in such a way that it shall be visible from all the 360 degree from below. In some cases where the visibility of the detector is obstructed by cable trays, false ceiling etc. Facility for connecting the detector to a response indicator has to be present. The response indicator derives the power to glow from the loop.		
7	It shall possess False alarm immunity and a superior signal to noise ratio		
8	It shall have a Built-in signal processor		
9	It shall be with 2 inbuilt fault isolators. (Detectors without Inbuilt Isolators may be considered with separate Isolator Base)		
10	It shall have drift compensation facility-built in.		
11	The detectors shall communicate the ambient reading to the FACP on time to time basis, and the FACP shall make the decision about the current status of the detector, whether it is in fire/pre-alarm/maintenance requirement etc.		
12	The detector shall have at least 15 levels of sensitivity settings based on the application and room where it is installed.		

S. No	Technical Requirement	Compliance Yes/No	Remarks
13	The detector shall provide a chambermaid plug to blow out the dust/dirt using a blower.		
14	In case of a failure, panel shall allow to replace the detector with the same type without the need of additional programming		
15	The detector shall be programmed to work as Optical only or Thermal only detectors. It shall a provision to switch off any component (optical or thermal) of the detector.		
16	The detector shall work with 2 different sensitivity settings at any point of time and the User shall have access to choose the desired settings without programming or Laptop/PC for configuration		
17	The detector shall be capable of detecting both smoldering fires and open fires and shall be UL/EN54 /VdS /FCC/CE approved		

#### 3.5.4 Intelligent Addressable Heat Detector

S. No	Technical Requirement	Compliance Yes/No	Remarks
1	The Intelligent Addressable Heat Detector used in this Building shall confine to the relevant standards having the following features		
2	The Heat detection system shall be of Rate of rise of temperature and Fixed Temperature		
3	The Intelligent Addressable Heat Detector shall be of Spot type and Addressable type		
4	The Intelligent Addressable Heat Detector shall be addressed either by DIP switches or through Programming from the Panel		

S. No	Technical Requirement	Compliance Yes/No	Remarks
5	The Detector shall monitor EMC/EMI values in the surroundings on a continuous basis and report the current & average values to the panel. The detector and the panel shall together avoid the possibility of false alarm caused due to interferences from sources such as Motors, power cables, Wi-Fi routers, fluorescent lamps, network switches, mobile signals...etc.		
6	All the detectors shall have a visible multi-colour LED to indicate the healthiness / trouble / alarm condition of the detector. The LED shall be located in such a way that it shall be visible from all the 360 degree from below. In some cases where the visibility of the detector is obstructed by cable trays, false ceiling etc. Facility for connecting the detector to a response indicator has to be present. The response indicator derives the power to glow from the loop.		
7	It shall possess False alarm immunity and a superior signal to noise ratio		
8	It shall have a Built-in signal processor		
9	It shall be with 2 inbuilt fault isolators. (Detectors without Inbuilt Isolators may be considered with separate Isolator Base)		
10	It shall have drift compensation facility built-in.		
11	The detectors shall communicate the ambient reading to the FACP on time to time basis, and the FACP shall make the decision about the current status of the detector, whether it is in fire/pre-alarm/maintenance requirement etc.		
12	The detectors shall communicate the ambient reading to the FACP on time to time basis, and the FACP shall make the decision about the current status of the detector, whether it is in fire/pre-alarm/maintenance requirement etc		
13	In case of a failure, panel shall allow to replace the detector with the same type without the need of additional programming		



S. No	Technical Requirement	Compliance Yes/No	Remarks
14	The detector shall work with 2 different sensitivity settings at any point of time and the User shall have access to choose the desired settings without programming or Laptop/PC for configuration		
15	The detector shall be capable of detecting both smoldering fires and open fires and shall be UL/EN54 /VdS /FCC/CE approved		

### 3.5.5 Manual Call Point

S. No	Technical Requirement	Compliance Yes/No	Remarks
1	Manual call points shall be of Double action - break glass type with Push Button.		
2	The mounted arrangement shall be such that it can be either surface mounted or flush mounted		
3	Each addressable MCP will comprise of an electronic circuit built into it to provide addressing capability		
4	The MCPs shall be provided with 2 inbuilt fault isolators. (the bidder shall consider an external isolator if not inbuilt)		
5	The MCP shall have a LED to indicate Alarms		
6	The MCP shall be UL/EN54 /VdS /FCC/CE approved		

### 3.5.6 Addressable Control Relay Module

S. No	Technical Requirement	Compliance Yes/No	Remarks
1	The CRM shall provide a dry potential contact o/p for activating a variety of auxiliary devices and other firefighting / ventilation equipment.		
2	It shall have a capability of handling at least 1A @ 30VDC to integrate with third party system.		
3	The CRM shall be addressable either by Dip switch or by the Panel		
4	The CRM shall be provided with 2 inbuilt fault isolators. (the bidder shall consider an external isolator if not inbuilt)		
5	The CRM shall be loop powered and shall be UL/EN54 /VdS /FCC/CE approved		

### 3.5.7 Monitor Module

S. No	Technical Requirement	Compliance Yes/No	Remarks
1	The MM shall provide 2 inputs and these inputs shall work independently to monitor 3rd party devices and shall allow to program with different parameters		
2	The MM shall have 2 inbuilt fault isolator modules. (bidder shall consider external isolators if not inbuilt)		
3	The MM shall be programmed to monitor contacts, Voltage and EOL resistor as per site applications		
4	The MM when programmed to monitor contacts shall also allow to program to monitor either open/close contacts		
5	The MM shall be addressable either by Dip switch or by the Panel		
6	The MM shall be loop powered and shall be		

S. No	Technical Requirement	Compliance Yes/No	Remarks
	UL/EN54 /VdS /FCC/CE approved		

### 3.5.8 Addressable Loop Powered Sounder

S. No.	Technical Requirement	Compliance Yes/No	Remarks
1	The Sounder shall be an Addressable loop powered sounder. (Bidder shall consider external power supply, cable, conduits, modules required for activating externally powered sounders and include the costing as part of the item – Sounders)		
2	The Sounder shall have 2 inbuilt fault isolator modules. (bidder shall consider external isolators if not inbuilt)		
3	The Sounder shall either be addressed by Dip switch or by the Panel		
4	The Sounder shall be placed in the detection loop only and a separate loop or cables for sounders shall not be used		
5	The sounder shall have a sound pressure level of 90dB and the volume shall be adjusted from the Fire Alarm Panel		
6	The sounder shall be capable of programming at least 32 different tones for alarm detection in different floors or at different time intervals		
6	The Sounder shall consume a minimal current of <5mA and thus allowing to connect at least 25 loop powered sounders in the same loop.		
7	The Sounder shall have a feature of synchronizing with other sounders in the loop		
8	The Sounder shall be loop powered and shall be UL/EN54 /VdS /FCC/CE approved		

### 3.5.9 Addressable Conventional Zone Module

S. No.	Technical Requirement	Compliance Yes/No	Remarks
1	Addressable interface units will be provided for all non-addressable detectors/devices such as beam detectors or to integrate existing conventional detectors, etc. to assign an address to such detectors and to be compatible with addressable FACP		
2	Each conventional detector will have its own addressable unit in the form of CZIM Modules for individual address. The addressable unit will facilitate connection of non-addressable detectors in the same circuit/loop consisting of addressable detectors.		
3	It shall supervise the circuit of open dry contact I/P device & signal alarms during change of state of detectors		
4	The interface device shall have an LED, which flashes during polling of the FACP		
5	The CZIM shall be capable of powering the Detectors through the Aux Source and shall supervise the cable, aux power and the external power supply. The CZIM shall communicate Faults and Troubles related to Detector, Power supply to the Panel		
6	It shall have 2 inbuilt fault isolator modules, or the bidder shall consider additional isolator modules		
6	The CZIM shall offer 2 separate zones, 2 Aux power circuits and shall monitor the external power supply and supervise the zone cables		
7	CZIM shall allow to configure the conventional zones with Different EOL and Alarm resistor based on the existing detector type		
8	CZIM shall be UL/EN54 /VdS /FCC/CE approved		

### 3.5.10 Beam Detector

S. No	Technical Requirement	Compliance Yes/No	Remarks
1	The beam detectors shall have a separate Transmitter (Tx) & receiver (Rx)		
2	Beam detectors shall be externally powered via Conventional Zone Interface module (CZIM). The module shall supervise the External Power Supply, Aux Power to the Transmitter and Receiver.		
3	The beam detector shall be suitable to protect the distance from 10 meters to 100 meters range.		
4	The beam detectors shall communicate the ambient reading to the FACP on time to time basis, and the FACP shall make the decision about the current status of the detector, whether it is in fire/pre-alarm/maintenance requirement etc.		
5	Beam detector shall have Response time less than 20sec		
6	The response threshold values, tests shall be as per NFPA 72.		
6	It shall have feature such that in case of accidental change of alignment, it shall report an error, it shall raise a maintenance request to the FACP		

### 3.5.11 Invisible Multicriteria Detector

S. No.	Technical Requirement	Compliance Yes/No	Remarks
--------	-----------------------	-------------------	---------

S. No.	Technical Requirement	Compliance Yes/No	Remarks
1	Microprocessor Based Addressable Invisible detector for smoke, optical component, for flush fitting in steel-reinforced concrete ceiling or suspended ceilings for Library Area		
2	Having a detection principle of two independent scattering light sensors with sensing volumes directly beneath the detector with features of drift compensation , contamination detection by means of a third optical system, protection against insects by means of a dual evaluation system , protection against external light in accordance with EN54-7 , chamber integrity monitoring, optical fault display , self-monitoring of sensors, programmable for timed automatic sensitivity selections with Junction Box and other accessories as required		
3	The detector shall be UL/EN54 /VdS /FCC/CE approved.		

### 3.5.12 Aspiration Detector

S. No	Technical Requirement	Compliance Yes/No	Remarks
1	Aspirating smoke detector, Highly sensitive smoke aspiration system for monitoring of rooms and equipment for earliest possible fire detection with max of 24 aspiration openings and a max pipe length of 180m.		
2	Protected area of max. 2880m <sup>2</sup> for one detector		
3	Three status displays on housing front panel for "operation", "alarm" and "malfunction"		
4	Adjustable sensitivity of up to 0,05%/m light obscuration		
5	Different sensitive detection modules possible		
6	Settable in day and night operation		

S. No	Technical Requirement	Compliance Yes/No	Remarks
7	Innovative air flow sensor technology - false alarm suppression		
8	Air stream monitoring with air pressure-dependent equalization		
9	Monitoring of pipe for breakage and obstruction		
10	To be integrated in Detector Loop		

### 3.6 Power Cables

The specifications for power cables shall be as below:

1. Conductor material: Stranded Copper
2. Insulation Material: Cables shall be PVC insulated as per application.
3. Voltage grade: 1100 V
4. Armouring: All power cables shall be GI wire armoured.
5. Sheathing Material: Inner & Outer sheaths shall be FRLS PVC

### 3.7 I&C Cables (FRLS)

The specifications of cables shall be as per data sheets in Section D. All multipair & multicore cables shall be provided with 20% (of used pairs/cores) spare pairs & cores for future use. Cables for Ethernet connectivity shall be CAT 6 cables, which shall be armoured. Cables for RS-485 connection shall be twisted pair cables, shielded & armoured.

#### **Cable Glands**

All cable glands shall be of double compression type with high quality neoprene gaskets. Cable glands shall be of brass with nickel plating.

#### **Cable trays**

- Cable trays shall be perforated of hot dipped galvanized steel. Cable trays shall have 50 mm collar height. The cable trays shall be covered type.

- Cables within the hospital block shall be laid on cable trays below false flooring. The cables coming in the beam area shall be allowed to pass through conduits.
- The cables laid between two different hospital buildings shall be laid in conduits in cable trenches.
- I&C Cables and power cables shall be routed through different cable trays to avoid Electromagnetic Interference.
- Minimum 300 mm distance shall be maintained between I&C Cables/24 V DC Power Supply Cables & 415 V AC/ 230 V AC Power Cables. All cable trays shall be provided with 20% spare space for future use.

### **3.8 Fire Proof Sealing For Cable Penetration**

Cables/ cable tray openings in walls and floors or through pipe sleeves from one area to another or one elevation to another shall be sealed by a fireproof sealing compound. The fire-proof sealing compound shall effectively prevent the spread of fire from the flaming to non-flaming side, in the event of fire.

### **3.9 Panels Accessories & Wiring**

#### **Wiring**

All inter cubical and internal wiring for all panels shall be carried out with 1100V grade, stranded tinned copper conductors with PVC insulation. The minimum size of the stranded copper conductor used for the panel wiring shall be 0.5 mm<sup>2</sup> for analog signals and 1.0 mm<sup>2</sup> for commands. For power supply, the conductor size shall be provided as per the load rating (min. 2.5 sq. mm for 230 V AC). Control & Power wiring shall be segregated and routed in PVC troughs. Different colour wires shall be used for different voltages.

- Engraved core identification plastic ferrules marked to correspond with the panel-wiring diagram shall be fitted at both ends of each wire. Cross ferruling shall be done. This shall also be applicable for fibre optic cable & cores.
- All spare contacts and spare terminals of the panel mounted equipment and devices shall be wired to the terminal blocks.
- Plug Points and Interior Lighting
- A 5/15 Amp 230V, 1 phase, 50 Hz, AC 3 pin plug point shall be provided in the interior of each panel with ON/OFF control switch and MCB.



- For interior lighting 230V, 1 Phase, 50 Hz, 40W compact fluorescent lamp with operating door switch and protective devices like MCBs shall also be provided.
- Power supply for all exhaust fans shall be provided through MCBs.

### **Relays**

All relays used for interposing shall have at least 2 nos. changeover contacts. The relays shall have status indication and shall be provided with freewheeling diodes.

### **Labels**

All front mounted equipment, as well as equipment mounted inside the panels/control desks shall be provided with individual labels with equipment designation engraved. These shall be phenolic overlays (1.6 mm thick) with black background and white lettering and shall be fixed to the panel by stainless steel screws (counter sunk). The panels shall also be provided at the top with a label engraved with the designation. Lettering for panel designation shall be 6 mm.

The minimum lettering size for instrument/device labels shall be 3mm. The lettering on the labels shall be subject to PURCHASER'S approval. Labels of internally mounted equipment shall be clearly visible.

### **Earthing**

Each panel shall be provided with a safety ground bus & system ground bus made of copper securely fixed along the inside base of the panels. These buses shall be typically of 25 mm wide and 6 mm thick of copper. The safety ground bus shall be properly secured to the plant safety earthing. All metallic cases/frames of relays, instruments, other panel mounted equipment shall be connected to the safety ground bus and shields & drain wires of signal/control cables shall be connected to the system ground bus by independent copper wires of not less than 2.5 sq. mm. The system ground bus shall be electrically isolated from AC mains earthing bus. The system ground bus shall be insulated from the panel body. The insulation colour code for earthing wires shall be green with yellow bands.

## **3.10 Networking of Facp**

The system supplied under this specification shall utilize node-to-node, direct-wired multi-priority peer-to-peer network operations. The backbone shall be Single mode Fibre optic cable or copper wire. A Minimum of 64 ten loop panels shall be capable of being networked together and each panel shall have capability of addressing 1980 points. The system shall utilize independently addressed, smoke detectors, heat detectors and input/output modules as described in this specification.

The peer-to-peer network shall contain multiple nodes. Each node is an equal, active functional node of the network, which is capable of making all local decisions and generating network tasks to other nodes in the event of node failure or communications failure between nodes. When a network is wired in a Class B configuration, a single break or short on the network wiring isolates the system into two groups of panels. Each group continues to function as a peer-to-peer network working with their combined databases. If multiple wiring faults occur, the network re-configures into many sub-networks and continues to respond to alarm events from every panel that can transmit and receive network messages. The remote-control panel/network nodes shall meet the same requirements as described in control panel section and shall contain Common control switches with minimum 160-character LCD display, as required with Integral power supply(s) with secondary stand-by power. It shall also have signalling line circuits for communications with analogue addressable devices, as required, audio amplification, as required, Notification appliance circuits, as required and auxiliary function circuits and operations, as required.

The network communication shall be based on a Local Area Network (LAN) or MODBUS on RS485. The network shall use a deterministic token-passing method. Collision detection and recovery type protocols are not acceptable substitutes due to life safety requirements. Failure of any node shall not cause failure or communication degradation of any other node or change the network communication protocol among surviving nodes located within distance limitations.

### **3.11 Interface With The PA/GA System**

The Fire Detection System shall be hardwired interface with PA system. In case of any emergencies or detection of fire, alarm signal shall send to PA system to activate alarm tone generator and to play recorded message.

### **3.12 Interfaces With The HVAC System**

The Fire Detection System shall be hardwired interfaced with HVAC system. In case of any emergencies or detection of fire, affected fire zone AHU, FCU and motorized fire/smoke dampers shall get close.

### **3.13 Interfaces With The Security System**

The Fire Detection System shall be hardwired interfaced with SECURITY system. In case of any emergencies or detection of fire, affected zone control doors shall get released.

## 4.0 CLOSED-CIRCUIT TELEVISION (CCTV) CAMERA

### 4.1 General Requirements - CCTV

- Supply, installation, testing and commissioning high quality fast-acting IP CCTV surveillance system along with power supply, power distribution and required accessories in different blocks of Integrated Command Control Centre (ICCC), Guwahati (Assam).
- The CCTV surveillance system should consist of IP Fixed cameras (indoor type), PTZ & fixed box cameras (outdoor type), software, server, power supply and cables.
- Video management software shall offer both video stream management and video stream storage management. Recording frame rate and resolution in respect of individual channel shall be programmable.
- Cat-6/6e Cable/Fibre cable connectivity with all required hardware up to ICT control Room or networking switch room,

#### **EXCLUSION:**

- PAN city storage infrastructure (under System Integrator Project) shall be used for ICCC video camera video footage.

### 4.2 Specifications of Components

#### 4.2.1 2 MP -IP Dome & Bullet Camera

Dome & Bullet Camera	Minimum Configuration Requirements
Type	Dome & Bullet
Image Sensor	1/3" Progressive Scan
Resolution range	(1920 - 2100) x (1080- 1200) complied with SMPTE 274M-2008
Frame rate	30 fps at full resolution (16:9) or better
Compression	H.265/H.264 or superior, MJPEG

<b>Dome &amp; Bullet Camera</b>	<b>Minimum Configuration Requirements</b>
WDR Measured according to IEC 62676 Part 5	80 dB or better
Video Streaming	Quad streaming Stream, fully configurable
Alarm Input and Output	01 I/p, 01 relay O/P
Network Port	RJ45 10/100 Base T
Protocol	TCP, HTTP, HTTPS, SMTP, SNMP, SNTP, RTP, RTSP, SSL, 802.1x, QoS, DNS, ICMP, UPNP, DDNS, IP v4 & v6 Remote Administration: Remote configuration and status using web-based tool
Lens	3 to 9 mm
Focus	Auto focus and zoom
Illumination / Sensitivity at F1.3, 30IRE	0.3 lux; Mono: 0.03 lux IR Distance, 30 meters or better
Audio	Built-in Microphone
Operating Temperature:	- 20° - 50° C
Video Analysis (edge based)	Object in field, Line crossing, Enter / leave field, Loitering, follow route, Idle / removed object, Counting, Occupancy, Crowd density estimation, Condition change, Similarity search - licenses for all these analytics to be considered with camera.
Electronic Shutter Speed (AES)	1/30 s to 1/10000 s
BLC	Required
Security	Network authentication with EAP/TLS, Embedded Login Firewall, on-board Trusted Platform Module (TPM) and Public Key, Infrastructure (PKI) support.
Other features	ONVIF: Profile S Compliant Signal to Noise Ratio: ≥55db
Local Memory	Minimum 128 GB with class6 or higher from day one (during downtime of the connectivity to server, captured data should be stored locally and the same should automatically upload into the storage after restoring of connectivity)

<b>Dome &amp; Bullet Camera</b>	<b>Minimum Configuration Requirements</b>
Certification	CE, FCC, UL, EN

#### 4.2.2 2 MP - IP PTZ Camera

<b>2 MP – IP PTZ Camera</b>	<b>Minimum Configuration Requirements</b>
Image Sensor	1/3" Progressive Scan CMOS or better
Resolution	1920x1080, complied with SMPTE 274M-2008
Frame rate	60 fps at all resolutions
Compression	H.265/H.264 or superior, MJPEG
WDR Measured according to IEC 62676 Part 5	90 dB or better
Video Streaming	Quad streaming Stream, fully configurable Camera shall have minimum fully configurable 3 h.264/h.265 and 1 M-jpeg
Alarm Input and Output	01 I/p, 01 relay O/P
Network Port	RJ45 10/100 Base T
Protocol	TCP, HTTP, HTTPS, SMTP, SNMP, SNTP, RTP, RTSP, SSL, 802.1x, QoS, DNS, ICMP, UPNP, DDNS, IP v4 & v6 Remote Administration: Remote configuration and status using web-based tool
Lens	(4.3-4.5) mm - (129-135) mm (F1.6 - F4.4) for 30x Optical zoom, Digital zoom of 16x
Focus	Automatic with manual override
Illumination / Sensitivity at F1.6, 30 IRE	Colour: 0.05 lux Mono: 0.01 lux. IR Distance: 170 Mtrs or better (Internal /External with 360 degrees coverage) IR from Camera OEM only
Audio Compression	Two-way Audio: Required Input / Output: 1in and 1out
Preposition Accuracy	± 0.1°
Protection:	IP66 enclosure

<b>2 MP – IP PTZ Camera</b>	<b>Minimum Configuration Requirements</b>
Operating Temperature:	-20° to 60°
Video Analysis (edge based)	Object in field, Line crossing, Enter / leave field, Loitering, follow route, Idle / removed object, Counting, Occupancy, Crowd density estimation, Condition change, Similarity search - licenses for all these analytics to be considered with camera.
Electronic Shutter Speed (AES)	1/30 s to 1/15000 s
BLC	Required
Defog	Required
PAN and Tilt Speed	Pan: 0.1°/s - 240°/s; Tilt: 0.1°/s - 120°/s
Security	Network authentication with EAP/TLS, Embedded Login Firewall, on-board Trusted Platform Module (TPM) and Public Key, Infrastructure (PKI) support. IP addresses which have never been successfully logged in and had more than 3 failed log-in attempts during the last 20 seconds are blocked and encryption protocol- TLS 1.2, SSL, DES, 3DES
PAN& Tilt Angle	PAN:360°; Tilt:3°-90°
Other features	ONVIF: Profile S Compliant Signal to Noise Ratio: ≥55db, Privacy mask supported at least 24 and 256 presets
Local Memory	Minimum 128GB with class6 (during downtime of the connectivity to server, captured data should be stored locally and the same should automatically upload into the storage after restoring of connectivity), Bidder to Provide 128GB SD Card with Camera
Certification	CE, FCC, UL, EN, IEC

### 4.3 Accessories

The Housing should be made of extruded Aluminum and should be weather proof. The minimum internal dimensions of the housing should be capable of housing the camera and the Varifocal lens.

- The camera housing should be: Compatible to camera
- Suitable for the make and model no of cameras offered and as specified by the manufacturer
- Should be compact and indoor / outdoor type as required.
- Suitable for operation in upright and inverted position'
- Should be weather proof in case of outdoor mounting.
- Should be Vandal proof

#### 4.3.1 Camera Mount

- The camera mount should be of the same make as that of camera and suitable for the model number offered as specified by the manufacturer.
- It shall be compact and indoor / outdoor type as required.
- It shall be supporting the weight of camera. Camera accessories such as housing pan & tilt head in any vertical or horizontal position.
- It shall be weatherproof in case of outdoor mounting.

#### 4.3.2 Cables

Connectivity	Cable Type	Connector
Camera to L2 Switch	UTP CAT 6	RJ45
L2 Switch to L3 Switch in control room	Single Mode Fibre	SC / OFC,
L3 Switch to Video Wall/Switches	UTP CAT 6	RJ45
From L3 switches to NVR/NAS Box	UTP CAT 6	RJ45

#### 4.3.3 Installation of UTP cable

- Cables should be dressed and terminated in accordance with the manufacturer's recommendations and/or best industry practices.
- Pair untwist at the termination should not exceed one-half an inch.

- Bend radius of the cable in the termination area should not be less than 4 times the outside diameter of the cable.
- The cable jacket should be maintained as close as possible to the termination point.
- Cables should be neatly bundled and dressed to their respective panels or blocks. Each panel or block should be fed by an individual bundle separated and dressed back to the point of cable entrance into the rack or frame.
- The distance between UTP data cable and any power cable should be more than 4 inches.
- Each cable should be clearly labelled on the cable jacket behind the patch panel at a location that can be viewed without removing the bundle support ties. Cables labelled within the bundle, where the label is obscured from view should not be acceptable.
- Cables should be installed in continuous lengths from origin to destination (no splices).
- Horizontal distribution cables should be bundled into groups of not greater than 40 cables. Cable bundle quantities more than 40 cables may cause deformation of the bottom cables within the bundle.
- Cables should not be attached to ceiling grid or lighting support wires.
- Any cable damaged or exceeding recommended installation parameters during installation should be replaced by the contractor prior to final acceptance at no cost.
- A self-adhesive label or PVC marker ferrules should identify the Cables. A cable label should be applied to the cable behind the faceplate on a section of cable that can be accessed by removing the cover plate. Similar label or marker ferrules should also be placed on a section of the cable near to the patch panel termination.
- Pulling tension on 4-pair UTP cables should not exceed 25-pounds for a single cable or cable bundle. The pathway should be adequately sized so as not to exceed the 80% cross-section fill of cables. The pathway should be securely installed in the facility.
- Care should be taken when pulling cables into trucking to avoid damage due to snagging. Trucking partitions should be used to separate the data cables from power, and bridges should be used where data cables must cross the mains.

#### **4.3.4 Instruction of OFC cable**

- Proper cable preparation is essential for splicing and installation. The following points outline some special precautions which are specific to fibre optic cable installation and therefore need to be noted.



- **Fibre Stress:** The fibres in the cable should not be subject to any undue stress. This means that if the cable is to be pulled into a long duct route then the specialized equipment and procedures should be used. As well, if the cable runs vertically for a significant length (more than 10m) then loop should be provided every 10m.
- **Bend Radius:** The cable manufacturer's minimum bend radius should be observed. i.e. there should be no bends tighter than specified either during installation or once cable has been seen fixed.
- **Cable Ties:** If cable ties are used, then it is very important that they are not over tightened, thereby causing localized bending and fibre stress.
- **Spare Cable:** At least 5m of cable should be left at each end to allow testing, positioning of enclosures, spare fibre for repairs etc. Where appropriate, spare loop of cable should be included along the cable run to assist repair in case of accidental damage.
- **Labelling;** All cables and cable end should be labelled clearly.
- **Cable End Protection:** Where cable ends are to be left exposed then they should be sealed with heat shrink caps to prevent ingress of dirt or moisture.
- **Earthing:** In many circumstances completely, non-metallic fibre optic cables can be used to eliminate all earthing problems. If metallic elements are present, then they should be earthed in accordance with the installation.

#### **4.3.5 Light guide Interconnect Unit (LIU)**

It should be installed for terminating the OFC cables. It shall provide minimum bending radius and the splice trays shall function as a splice cover for pigtail splicing. It shall be of complete Aluminium fully powder coated. Cable glands shall be provided for secure anchoring the incoming cables. Rubber grommets shall be provided at the cable entry point for tight sealing. The splice tray shall also be of Aluminium powder coated with splice holder. Cable spools shall of flame retardant.

#### **4.3.6 OFC Connectors**

It shall be single mode SC type with push-pull mechanism. Fully compliance with latest industry standards. It shall be possible for selection of wide range of ferrule hole diameter selection.

#### **4.3.7 OFC Adapters**

It shall be suitable for single mode SC type fibre cable connectors. Fully-compliance with latest industry standards. It shall be with snap / latch mechanism.

#### **4.3.8 OFC Patch Cords**

It shall be suitable for single mode SC type fibre cable connectors with plastic moulded plug type connectors. Standard 2.5 mm ceramic ferrules shall be used. It shall be compact and easy to connect.

#### **4.3.9 Power Wiring System**

Rigid PVC (heavy duty) Conduit Wiring System as per IS: 9537.

#### **4.3.10 Conduits**

- All rigid conduit pipes shall be of PVC and be ISI marked. The wall thickness shall be not less than 1.6 mm for conduit up to 32 mm dia and less than 2 mm for conduits above 32 mm dia.
- The maximum number of PVC insulated cables conforming to ISI: 694-1990 that can be drawn in one conduit as per standard norms. Conduit sizes shall be selected accordingly in each room.
- No conduit less than 20 mm in diameter shall be used.
- Flexible conduits will only be permitted for interconnections between switchgear, DB's and conduit terminations in wall.
- All flexible conduits used in the system should be Halogen free, flame retardant and self-extinguishing polyamide conduits.

#### **4.3.11 Conduits Accessories**

- The conduit wiring system shall be complete in all respects, including their accessories.
- All conduit accessories shall be of solvent cement plastering type and under no circumstances pin grip type of clamp grip type accessories shall be used.
- Bends, couplers, etc. shall be solid type in recessed type of works and may be solid or inspection type as required.

- Saddles for surface conduit work on wall shall not be less than 0.55 mm (24 gauge) for conduit up to 25 mm dia. and not less than 0.9 mm (20 gauge) for larger diameter.
- The minimum width and the thickness of clips used for fixing conduit to steel joints, and clamps shall be per standard norms.

#### **4.3.12 Outlets**

- The switch box or regulator box shall be made of metal on all sides, except on the front (In case of cast boxes). The wall thickness shall be at least 2 mm and in case of welded mild steel sheet boxes, the wall thickness shall not less than 1.2 mm (18 gauge) for boxes up to a size of 20 cm x 30 cm, and above this size 1.6 mm (16 gauge) thick MS boxes shall be used. He metallic boxes shall be duly painted with anticorrosive paint before erection.
- An earth terminal with stud and 2 metal washers shall be provided in each MS box for termination of protective conductors and for connection to socket outlet/metallic body of fan regular etc.
- Clear depth of the box shall not be less than 60 mm, and this shall be increased suitably to accommodate mounting of fan regulators in flush pattern.
- The fan regulators can also be mounted on the switch box covers, if so stipulated in the tender specifications, or if so directed by the Engineer-in-charge.
- Except where otherwise stated, 3 mm thick phenolic laminated sheets as per clause shall be fixed on the front with brass or cadmium plated iron screws as approved by the Engineer-in-charge

#### **4.3.13 Wires**

Wires shall comply the following features:

- PVC insulated with a rating of 105 deg. C bright annealed electrotype grade (99.9% pure) copper standard conductors multi drawn simultaneously (Unilay, twisted conductors) for uniformity of resistance, dimension and flexibility.

#### **4.3.14 Installation**

- The conduit work of each circuit or section shall be completed before the cables are drawn in.
- Conduit pipes shall be joined by means of couplers and accessories only.

- Cut ends of conduit pipes shall have no sharp edges, nor any burrs left to avoid damage to the insulation of conductors while pulling through such pipes.

#### **4.3.15 Bends in conduit**

- All necessary bends in the system, including diversion, shall be done either by neatly bending the pipes without cracking with a bending radius of not less than 7.5 cm, or alternatively by inserting suitable solid or inspection type normal bends, elbows or similar fittings, or by fixing cast iron inspection boxes, whichever is most suitable.
- No length of conduit shall have more than four bends from outlet to outlet.
- Additional requirements for recessed conduit work.

#### **4.3.16 Marking**

- The chase in the wall shall be neatly made, and of ample dimensions to permit the conduit to be fixed in the manner desired.
- In the case of buildings under construction, the conduit shall be buried in the wall before plastering and shall be finished neatly after erection of conduit.
- In case of exposed brick/rubble masonry work, special care shall be taken to fix the conduit and accessories in position along with the building work.

#### **4.3.17 Fixing conduits in chase**

- The conduit pipe shall be fixed by means of staples hooks or by means of saddles, not more than 60 cm part, or any other approved means of fixing.
- All joints of conduits pipes shall be treated with some approved preservative compound to secure protection.

#### **4.3.18 Fixing conduits in RCC work**

- The conduit pipe shall be laid in position and fixed to the steel reinforcement bard by steel binding wires before the concreting is done. The conduit pipes shall be fixed firmly to the steel reinforcement bars to avoid their dislocation during pouring of cement concrete and subsequent tamping of the same.

- Fixing of standard bends or elbow shall be avoided as far as practicable, and all curves shall be maintained by bending the conduit pipe itself with a long radius which will permit easy drawing in of conductors.
- Location of inspection / junction boxes in RCC work should be identified by suitable means to avoid unnecessary chipping of the RCC slab subsequently to locate these boxes.

#### 4.3.19 Fixing inspection boxes

- Suitable inspection boxes of the minimum requirement shall be provided to permit inspection, and to facilitate replacement of wires, if necessary.
- These shall be mounted flush with the wall or ceiling concrete. Minimum 65 mm depth junction boxes shall be used in roof slabs and the depth of the boxes in other places shall be as per IS:2667 – 1977.

#### 4.3.20 Fixing switch boxes and accessories

- Switch boxes shall be mounted flush with the wall. All outlets such as switches socket outlets, etc. shall be flush mounting type, unless otherwise specified in the Additional Specifications.

#### 4.3.21 Bunching of cables

- Cables shall be always be bunched so that the outgoing and return cables are drawn into the same conduit.
- In case of three phase loads, separate conduits shall be run for each phase from the distribution boards to the load points, or outlets as the case may be.

### 5.0 PUBLIC ADDRESS SYSTEM (BUILDING)

#### 5.1 Equipment Specification

##### 5.1.1 Network controller

Network Controller			
S. No	Technical Specification	Compliance (Yes/No)	Remarks
1	MAKE/Model		

Network Controller			
S. No	Technical Specification	Compliance (Yes/No)	Remarks
2	IP based EVAC PA controller capable of adding 12 zones in the system and expandable up to 150 zones		
3	14x 4 Audio matrix with full DSP functionality		
4	8 audio inputs, 4 audio outputs, 4 channel output matrixes.		
5	Shall support amplifier redundancy		
6	12 speaker line outputs.		
7	8000 fault, warning and event conditions log.		
8	Built in message manager for 100 emergency/business calls up to 85 minutes.		
9	18 control inputs and 19 control outputs.		
10	Impedance measurement and Pilot Tone supervision for speaker line monitoring.		
11	The controllers shall be able to exchange audio signals over the network without the need of a running PC/server, software dependent solutions shall not be accepted.		
12	Multiple controllers can be networked over IP using Dante audio up to 16 digital audio input signals and 16 digital audio output channels with low latency.		
13	Audio flows Up to 16 × 16 simultaneous audio streams@48kHz.		
14	Frequency response (ref. 1 kHz) 20 Hz to 20 kHz (-0.5 dB)		
15	Signal-to-noise ratio (A-weighted): Line in to line out: 106 dB typical		
16	THD+N < 0.05%		
17	Sample rate 48 kHz, DSP processing resolution 24-bit linear A/D and D/A conversion, 48-bit processing		

### 5.1.2 Router

Network Controller Router			
S. No	Technical Specification	Compliance (Yes/No)	Remarks
1	MAKE/Model		
2	EVAC Router for adding 24 zones in the system		
3	2-in-6 matrix.		
4	20 Control Inputs, 26 Control Outputs.		
5	'Shall support amplifier redundancy.		
6	Impedance measurement and Pilot Tone supervision for speaker line monitoring.		

### 5.1.3 Power amplifiers

The main function of the power amplifier is the amplification of audio signals for the loudspeakers. It shall be possible to select the output voltage between 100V and 70V by changing jumpers. It should have at least the following functionalities:

S. No	Technical Specification	Compliance (Yes/No)	Remarks
1	2x 500W Class D, high efficiency amplifier.		
2	70/100V loudspeaker output voltages, 4 automatic selectable audio inputs, local input for audio source.		
3	THD $\leq$ 1%. Frequency response, ref. 1 kHz, rated load, -3 dB: 50 Hz to 25 kHz.		
4	Signal-to-noise ratio (A-weighted) > 104 dB.		
5	Audio input level limiter, RMS output power limiter, high temperature, DC, short circuit, mains undervoltage protection, DC supply undervoltage protection, inrush current limiter, ground fault		

#### 5.1.4 Call Station

S. No	Technical Specification	Compliance (Yes/No)	Remarks
1	Call Station with extension keypad to with minimum 35 programmable keys for Zone selection, source selection, level control, emergency on/off, message on/off, failure acknowledge/reset		
2	Switching output trigger on/off or 0 to 10V, select scheduled events, scheduled event on/off.		
3	Multilanguage LC display (122 × 32) pixel, Five menu/function keys		
4	Gooseneck microphone with supervised electret microphone		
5	Pop shield and permanent monitoring, integrated loudspeaker for system sounds.		
6	The call station should have the provision to be configured as a numeric keypad.		

## 5.2 Loudspeaker

### 5.2.1 6 Watt Ceiling Type Loudspeaker

A flush-mounting ceiling loudspeaker is available for general application. These full range loudspeakers are suitable for both speech and music reproduction. The speaker assembly consists of a single piece, 6 W loudspeaker and frame with a 100 V matching transformer mounted on the back.

S. No	Technical Specification	Compliance (Yes/No)	Remarks
1	6W ceiling mount speaker Make/Model		



S. No	Technical Specification	Compliance (Yes/No)	Remarks
2	- Max Power: 9W, Rated Power: 6Watts, Power Tapping: 6/3/1.5W		
3	- Effective frequency range (-10 dB) :150 Hz - 15 KHz		
4	- SPL at rated power (1Khz at 1 m) 108.8 dB		
5	- Opening Angle 1 KHz / 4 KHz (-6 dB): 180/45		

### 5.2.2 20 Watt Ceiling Type Loudspeaker

S. No	Technical Specification	Compliance (Yes/No)	Remarks
1	20W ceiling mount speaker Make/Model		
2	- Rated Power: 20Watts, Power Tapping: 6/3/1.5W		
3	- Effective frequency range (-10 dB) :100 Hz - 15 KHz		
4	- SPL at rated power (1Khz at 1 m) 104 dB		
5	- Opening Angle 1 KHz / 4 KHz (-6 dB): 176/44		

### 5.3 PA Equipment Cabinets

The PA equipment shall be of field proven and rugged construction. The system shall take future requirements into consideration. A minimum of 25 % spare amplifiers shall be supplied for future expansion. In addition, 20 % of unused shelf space shall be available in the cabinets.

- Free-standing (2050 H x 800W x 800 D) mm standard front-access 19" 42U cabinets shall be provided by CONTRACTOR. Colour to be RAL 7032.

- The equipment racks shall be fitted with glazed front doors and a plain back door.
- The battery and MDF rack shall be fitted with plain metal doors.

The PA/GA equipment rack shall house the following equipment:

- Central monitoring unit for sound broadcasting network and messages
- EVAC Monitoring module for 3 lines of speakers and amplifiers
- Signal processing units,
- Amplifiers and 100-V line transformers,
- MDF with cable gland.
- Control and zone selection circuitry,
- PAS Access Units and interface circuitry,
- Fault monitoring equipment,
- Redundant alarm tone generators,
- Built-in testing unit,
- Access and monitor panel,
- Alarm inhibit switch,
- Battery charger.

19 "Equipment Rack,16U Made of MS for housing of all above equipment, front lockable glass door, Fan tray from Colling, Caster wheel base, Main Panel with Spike Buster, Individual FUSE power supply unit, including all internal wiring/ interconnection as required

The PA equipment racks shall be equipped with a front panel alarm inhibit switch to isolate the related PA system from the Fire equipment in order to prevent the accidental activation of the Fire Alarm during maintenance activities. The switch shall be equipped with a key to prevent unauthorized use. The alarm inhibit switch shall provide a feedback loop to the Fire system (open when the alarm is inhibited). A red/green front panel LED indication on the Access Units shall inform the operators of the status of the two Alarm Inhibit Switches.

#### **5.4 Network Switch For PAS**

Network Switch with 1 Gbit or higher with hardware switching capabilities. (Optional) IGMPv3 or IGMPv2 snooping.

To optimize bandwidth usage, IGMP snooping can be used. This is useful in systems with >10 multicast channels, although not absolutely required. Sufficient performance for handling a large number of IGMP query responses, depending on the number of (directly or indirectly) connected devices to that switch. Hardware support for IGMP is strongly recommended

#### **5.5 PAS MDF**

All PA/GA cable pairs shall be terminated in MDF including:

- Loudspeaker distribution cables,
- Interconnecting cables to control points,
- Interconnecting cables to Fire system.

High voltage terminals shall be kept segregated from other terminals and covered with transparent Perspex panels.

The MDF shall be equipped with screw-type terminal blocks.

Four (4) terminals shall be provided for each individual loop. The MDF shall be equipped with facilities for connecting, disconnecting and cross-connecting field-side and amplifier-side wires. All terminal blocks shall be fitted with markers for easy identification.

The MDF shall be equipped with separate earthing facilities for terminating the dual steel tape armour and the screens of each loudspeaker distribution cable. The cable screens shall be connected to the isolated earth bar, the armours to the protective earth bar.

#### **5.6 PAS Cables**

All indoor PA/GA distribution cables shall be unarmoured /armoured and fire-resistant; while the outdoor PA distribution cables shall be armoured and fire-resistant cables.

This requirement also applies to the power cables feeding the PA Central Equipment Racks and to interconnecting cables with the control points.

<b>Features</b>	<b>Descriptions</b>
Flame resistance:	In compliance with IEC 331
Conductors (LS loops):	2 pairs, 1.0 sq. mm stranded tinned copper wire
Insulation:	XLPE
Twinning:	Lay length not to exceed 70 mm
Screening:	Pairs to be individually screened
Inner sheath:	Low Smoke, zero halogen (LSZH)
Armour:	Dual steel tape
Overall Outer sheath:	Fire Resistance Low Smoke
Outer sheath colour:	Black

## **5.7 Power Supply**

- PA Systems shall be powered from 230VAC 50Hz power supply (UPS).
- The UPS are themselves shall be power from the facility Essential power mains. As per safety requirement, the UPS battery capacity shall be design such that the PA/GA system must be able to operate for 60 minutes under continuous alarm.
- Interface with the Fire detection and alarm System

## **6.0 ACCESS CONTROL SYSTEM**

### **6.1 Access Control – General Requirements**

- A. The system shall use intelligent distributed processing controller architecture with access decisions being made locally at each controller without reference to any other processor
- B. The ACS main server shall connect to IP controllers and Field Networks with RS485 controllers
- C. A Field Network shall support 32 Intelligent Controller nodes
- D. There shall be no limit to the number of Intelligent Controllers per system

- E. An Intelligent Controller node shall consist of an Intelligent Door Controller (IDC) or an Input / Output Controller (IOC)
- F. Controllers shall be installed into purpose made steel enclosures and shall be powered by local mains power or POE. Every power supply, including POE shall include battery back-up and battery charging circuits
- G. The ACS main server shall download controller-specific data to each Intelligent Controller node. This data shall be stored at the controller and shall be pertinent information relating to the controller's functionality. Should communication with the ACS main server be lost, the controller shall continue to operate without degradation of security whilst transaction data including event activity and its date and time stamp shall be stored at the controller. Upon restoration of communications transaction data shall be automatically uploaded to the ACS main server for future historical reporting
- H. Under normal system operation, Intelligent Controllers shall send details of events and transactions to the ACS main server to ensure that:
  - The latest data is always available in the central logs
  - Global functions such as area control and system-wide actions are maintained
- I. If communications are lost to an Intelligent Controller the controller shall enter into fall-back mode. In fall-back mode an IDC shall:
  - Carry on normal access control operations using its on-board database
  - Store up to 4,000 alarms, events and transactions
  - When the event buffer is full, the oldest, non-important events shall be over-written first
  - Automatically send stored data to the ACS main server upon return of communications.

## **6.2 Field Network - ACS**

- a) The system shall support multiple RS485 2-wire Field Networks
- b) Each Field Network shall support a minimum of 32 nodes which may consist of any combination of Intelligent Door Controllers and Input/output Controllers
- c) Field Networks shall connect to the ACS main server via an IP Field Network Line Header. USB or RS232 direct-connect line headers will not be accepted
- d) Field Networks shall be capable of extending to a minimum of 1,200m without boosters or repeaters. It shall be possible to include additional Intelligent Controller nodes without affecting the operation or set-up of any existing node
- e) Field Networks of greater distance than 1,200m shall be supported with suitable line drivers

- f) It shall be possible to connect at least three Field Network Line Headers to the same Field Network in order to provide superior communications resilience. In the event of a network communications failure the system shall be capable of automatically re-routing communications accordingly

### **6.3 Software - ACS**

- a) The Contractor shall provide all software required for efficient operation of all the automatic system functions required by this specification. Software shall be modular in design for flexibility in expansion or revision of the system. It is the intent of this specification to require provisions of a system that can be fully utilized by individuals with no, or limited, previous exposure to PC's and programming techniques and languages. The software shall include a general-purpose operating system, as well as access control system application software. All available vendor workstation application software shall be provided with the system and shall reside in each and every PC. Unbundled software packages where the vendor can charge the user extra fees, require dedicated workstations, require annual software renewal licenses or require systems rebooting for access are unacceptable.
- b) The software in the system shall consist of both "firmware" resident in the controllers / card reader cum controllers and "software" resident in the operator workstations. The architecture of the system, and the application software/firmware shall be distributed with no single-system component responsible for a control function for the entire sub controller LAN. Each controller resident on the system shall contain the necessary firmware and I/O capability to function independently in case of a network failure. No active control sequences shall be resident in the PC workstations. All PC workstations shall be removable from the system without loss of control function -- only alarm monitoring, long-term history collection, database additions/deletions, and operator monitor/command/edit functions would be lost.
- c) The primary operator interface to the system shall be through a graphical, "object oriented", interactive presentation using a mouse and cursor for object selection and commands. The SMS contractor shall work with the customer to complete fully integrated graphics pages allowing operators of the system to manipulate controlled points using only a mouse. The system shall not be limited to only one type of operator interface at a time.
- d) The system software shall support an operator definable "default" system page. The default system page shall be displayed upon system start-up, operator activity time-outs, and when the system is not in use. This default system page may be any one of the standard dynamic graphic pages or a custom display developed for this purpose. The operator shall be able to display their corporate logo, emergency information, etc. as the default system page.

- e) The system software shall support "pop-up" windows for point commands. On selecting an object with the cursor, a window shall open up to present the operator with choices corresponding to the operator's password authorizations. These point commands shall include state changes, manual override of application software, test mode activation and test value entry. This window shall include, for reference, the point's descriptor (name), the point's hardware address, and alarm status.
- f) The system software shall support "pop-up" windows for point editing. On selecting an object with the cursor, a window shall open up to present the operator with a list of active point database editors, if permitted by the operator's password level. Selecting one of these editors shall allow the operator to modify the basic parameters associated with a point, as well as access any programs assigned to the point (such as time schedules, calculations, events, etc.).
- g) The system software shall be based upon interactive prompts and choices using "dialog boxes," as opposed to memorization of commands, "syntax", exact spellings, etc. This interactive prompt and choices approach shall be used in monitoring, issuing commands, and editing. Command choices shall be as simple as "clicking" the cursor over the correct word choice prompts (i.e., SECURE, RELEASE, UNLOCK), without typing in the letters.
- h) The system software shall support a "zoom" function. It shall be possible for an operator to locate any system point to monitor status, issue commands, or edit associated database without knowledge of the point's name, address, or associated controller, and without having to refer to a "tree" directory. The operator shall be able to zoom in on a building in a campus graphic, zoom in on a floor in a building graphic, zoom in on a door in a floor plan graphic, etc.
- i) The system software shall be compiled for faster execution speeds and shall offer all of the following features and capabilities:
- j) Input / Output Capabilities: From any local PC workstation or any remotely connected PC workstation, the system operator shall have the capabilities through the keyboard/mouse to request dynamic displays of current values or status using a tabular or graphic format. A global database sort utility shall allow an expanded tabular display of only the points on the current graphic display. This expanded tabular display shall list point name, hardware address, dynamic state or value, alarm status, override status, and test mode status.
- k) Obtain a summary of all access control doors with status (under access control, access control disabled, or access control ignored) and allow issuing commands to the access control doors to manually force the door to one of the above states or provide a momentary release (act as a valid key/card access) or return to automatic control (remove manual state).

- l) Add, delete, or change points within each Controller or application routine while on-line.
- m) Change point I/O descriptors, status, and alarm descriptors and engineering unit descriptors while the system is on-line.
- n) Add new Controllers and sub-controllers to the system while the system is on-line.
- o) Develop, modify, delete or display full range of colour graphic displays providing dynamic, animated displays. All development, editing and display work shall be capable of being performed with the system fully on-line and in full communications with the Controllers and sub-controllers.

#### **6.4 Database Creation and Support**

- a) The intent of this specification is to provide an ACS that will allow the owner to independently perform his or her own modifications to the system from any operator workstation. All changes shall be done utilizing standard procedures and must be capable of being done while the system is fully on-line and operational.
- b) The DCU on the Controller LAN shall automatically check a PC workstation's database files upon connection to verify a current database match. A utility shall inform the operator if the DCU's database files do not match the backup files stored on the PC workstation, along with the date of the last DCU modification and date of the last backup. The owner must have, as a minimum, the on-line capability to:
  - c) Add, Delete and Modify and points and parameters.
  - d) Determine which PC workstation(s) will receive alarms, messages & transactions on a point by point / door-by-door basis.
  - e) Change, add, or delete English language descriptors (i.e., name). System I/O points may be identified either by name or by its logical address. Up to 16 characters shall be available for the English language descriptor, which shall be used in all control sequences. Use of a second abbreviated point "name" for control sequences is unacceptable complexity.
  - f) Add, modify, or delete alarm limits.
  - g) Add, modify, or delete individual records.
  - h) Add, modify, or delete points in start/stop programs, trend logs, etc.
  - i) Create and/or modify override parameters.



- j) Add, modify, and delete any applications program.
- k) Create custom relationship between points. A general-purpose user utility shall be provided, such that the user can implement software interlocks, calculations, etc.
- l) Assign application programs to points (as opposed to assigning points to programs).
- m) Obtain an "audit trail" of which application programs are controlling an individual point, on a point-by-point basis.

## **6.5 Door Parameters**

- a) Provide a door parameters editor, which shall include the following options:
  - b) Reader technology selected.
  - c) User definable Wiegand reader formats between 26 and 64 bits.
  - d) If the reader is for the cab of an elevator (lift).
  - e) If the reader is used for "exit" (pushbutton exit being the default), and if so, whether the exit reader is used for continuous egress or is linked to the Mode Schedule of an "entry" reader.
- f) The minimum time (in seconds) allowed between successive "reads". Used to adjust traffic flow rates through portals such as turnstiles.
- g) The polarity of the reader's LED used to indicate a good read, etc.
- h) Whether anti-passback (APB) is implemented or not.
- i) What the entry zone number is (APB).
- j) What the exit zone number is (APB).
- k) Escort required criteria.
- l) Anti-passback criteria
- m) Customizable reader buzzer control per event type.
- n) Whether the door sense switch is used, and if so whether it is a normally open (NO) or normally closed (NC) contact.

- o) Whether the Request to Exit (RTE) is used, and if so whether it is a normally open (NO) or normally closed (NC) contact.
- p) Whether a shunt function is used.
- q) Whether the door-locking device (e.g., an electric strike) is used, and if so, whether it is activated for entry requests, exit requests, or both.
- r) How long the locking device will be unlocked after an authorized read or RTE pushbutton operation. The unlock interval shall be adjustable from 1 to 255 seconds.
- s) "First Key Auto-Unlock" shall be available to provide additional security for doors that implement access control after hours and automatically unlock the doors on a time schedule during the day. This feature does not unlock the door until an authorized key is read after the scheduled unlock time. If this feature is not used, the door is unlocked per the Door Mode Schedule, regardless of key activity.
- t) "Door Prop" alarm timer setting. This setting shall ignore the door monitor switch input for alarming during the timer interval. The timer shall be adjustable (operator selectable) from 1 to 7200 seconds.
- u) Individual door configuration for 2-man rule.
- v) The polarity control of the reader audible device to be configured for individual sounds based upon the door event (forced door, valid card read, denied card read, door open to long).

## **6.6 System Passwords**

- a) To limit control by the system operators, the ACS shall support system passwords at both the host level and controller level.
- b) The host passwords shall limit user access and privileges to provide system level security. A password shall be required to "log on" to the system. The SMS host shall support up to 1,100 passwords. It shall be possible to enable or disable each and every individual function of the ACS on a password-by-password basis using a simple point and click operation. Each password shall allow a 30-character operator name, a 10-character alphanumeric password, and 4 characters for the operator initials.
- c) System passwords time out after a user-defined period of time.
- d) The SMS System shall also be capable in utilizing the customers' pre-issued network ID and password to automatically log them into the SMS system.

- e) Logon passwords shall allow for any number of limited views
- f) Automatic expiration of passwords as set by system administrator.
- g) Non-re-use of system passwords
- h) Screen settings and system configurations are remembered based on password log in.
- i) User configurable ID card log on in lieu of keyboard log on.
- j) Separate from the ACS logon an additional layer of passwords shall limit operators from gaining access to certain control panel functions. The controller passwords shall restrict user access and privileges to system controllers. The controller passwords shall support 4 levels:
  - **Level 1** – Display only access
  - **Level 2** – Display controller data, issue commands, acknowledge alarms.
  - **Level 3** – Display data, issue commands, acknowledge alarms and edit all functions except the DCU password function.
  - **Level 4** - Display data, issue commands, acknowledge alarms and edit all functions, including the DCU password function.

## 6.7 System Response Times

Any state change or alarm condition shall be communicated to the ACS system immediately and without delays. The times listed below shall serve as the ACS systems maximum times for doing automatic refreshes and point polling.

- **Change of State:** Time for a change of state or value of a field point to register an alarm or update at the workstation: 3 seconds.
- **Manual Command:** Time for a manual command from the workstation to override a field device: 1 seconds.
- **Graphics Display:** Time to display a full graphic with current parameter values: 8 seconds.
- **System Logs:** Time to display a system log or report: 1 seconds.
- **Global Data Transfer:** Time for data to travel between standalone controllers: 3 seconds.
- **Local Control Event:** Time for standalone controller to initiate an output action after a change of input: 2 seconds.

## 6.8 Specification – Access Control

### A. Access Door-Controller

S. No.	Minimum specification	Compliance	Remarks
1	Access Door-Controller - up to 8 Wiegand reader support		
2	Latest integrated 32-bit, 30 MHz Micro-controller based system architecture;		
3	On board Real Time Clock that will adjust itself to leap year computations automatically		
4	Access Door-Controller shall have 8 Relay outputs; 8 Analog Inputs; onboard LCD display 16 Characters		
5	16-characters liquid crystal display (LCD), shall display network parameters and actual status like: a. IP address of the controller b. MAC address of the controller c. DHCP on/off d. Status of all the inputs connected to it e. Status of all the outputs connected to it f. Online and Offline status of the controller g. Firmware version		
6	Access Door-Controller shall include a standard 2GB Compact flash (CF) memory card for storing cardholder data and access events.		
7	Memory shall store database that has a capacity with a minimum of 80,000 cardholders and Event buffer size: maximum of 4,00,000 events with date and time stamp.		
8	Access Door Extension for additional 4 WIEGAND reader support for above controller. Extension shall communicate to Main controller on Rs-485 Unit shall have 8 Inputs and 8 Outputs Unit shall be DIN-Rail Mountable		
9	Access Door-Controller housing		

S. No.	Minimum specification	Compliance	Remarks
10	Power supply with battery charger for Access Door-Controller		
11	Access Controller and Software shall be form same OEM		

### B. Smart Card Reader

S. No.	Minimum specification	Compliance	Remarks
1	Surface mounting style 13.56 MHz contactless smart card readers as per tender specifications		
2	Reader Type: Contact less smart card Mount type: Single Gang / Mullion Keypad: Optional Reader Output format: Wiegand Read Range: 5 cm – 7.5 cm LED/Beep: Tricolour LED + Beep Wiegand Interface: Yes		

### C. Smart Card

S. No.	Minimum specification	Compliance	Remarks
1	The Cards shall be up to 2 Kilobytes memory.		
2	Cards shall contain a contact less smart chip that operates at 13.56 MHz and shall conform to ISO 15693 and ISO 14443B2 standards for contactless smart cards.		
3	The data inside the card shall be secure with a unique, diversified security key with 64 bit encryption		
4	Operating Temperature: - -35 to 65 degrees C and Operating Humidity 5% to 95% relative humidity non-condensing		

#### **D. Access Control Software**

<b>S. No.</b>	<b>Minimum specification</b>	<b>Compliance</b>	<b>Remarks</b>
1	Access control software as per tender specifications and should be as same OEM of controller		
2	The Access Control System shall be a PC-based system based on Windows Operating Systems. Ability to store up to 10000 cardholder data and support up to 512 readers		
3	The Access Control System shall be of modular design providing the flexibility to allow the user to add or remove any components and/or controlled functions or in the event when operating requirements change or as system expands.		
4	The Access Control System shall support up to four (4) different Wiegand card formats simultaneously. The number of each format supported shall be unlimited.		
5	The Access Control System shall monitor and record in a logbook all movements and activities at each control point.		
6	It shall be a standard feature provided in the Access Control System management software for taking photos, scanning or importing cardholder images into the cardholder database. Such that stored cardholder's image can be displayed automatically on the Access Control System.		
7	The events log files shall include an advanced filter functions such that archive can be kept small and precise. If required, only desired information shall be archived.		
8	The system shall contain a map viewer. This map viewer shall provide a graphical presentation of the premises or object by means of floor plans, object pictures or any desired graphical representation		

### **7.0 INTEGRATED BUILDING MANAGEMENT SYSTEM (IBMS)**

#### **7.1 IBMS Intent**

- a) The BMS for the proposed Construction of Integrated Command Control Centre, Guwahati comprise of the following sub-systems:
  - i) Control and monitoring of MEP utilities using DDC controller based system and communication links with third party systems. This shall cover interlock with air conditioning and mechanical ventilation (HVAC) system, electrical System, water management, Fire Pump, DG System and equipment control/monitor.
  - ii) Soft point Integration of Fire detection & alarm system , DG, Energy Meters, UPS & Inverter.
  
- b) It is proposed to provide the building with an effective and energy efficient BMS System using equipment and all ancillary materials comparable to the best that is available with integration of various facilities in the complex into a seamless network that permits:
  - i) Automation of all general functions
  - ii) Automated initiation of actions for emergency functions
  - iii) Common user interface (Human Machine Interface – HMI) having following generic functions:
    - a. Ability to use the same all the sub-systems of the BMS.
    - b. Ability to access any information from any of the sub-systems of the BMS subject to user access privileges.
    - c. Ability to assign a particular control responsibility (view, view only, alarm acknowledge only or full control) to an operator for multiple sub-systems (e.g.: An operator is allowed to acknowledge alarms from fire alarm and Equipment fault at the same operator station).
  - iv) Ability to implement control / logic schemes in the system (not hardwired interlocks) utilizing data from any of the sub-systems to activate devices in any other sub-system.
  - v) The system shall have a common data base for all the sub-systems of the BMS.
  - vi) All the sub-systems shall integrate seamlessly to result in a homogenous system.
  - vii) The system shall be able to interface to microprocessor based systems using open protocols such as BACNet / LON /MODBus, etc.
  
- c) Integration of all systems should be achieved through autonomous distributed control systems, fail safe hardwired sensor-actuator-controller connectivity, standard pre-assigned dedicated LAN based communication, central data management system, software programs, visualization screens and data gathering, archiving and serving features.

## **7.2 Scaope of Work – IBMS**

**In general, the work to be performed under this contract shall comprise/include the following:**

- a) This specification covers the supply, installation, testing & commissioning of BMS including performance testing at the manufacturer's and / his System Integrator / Bidder/Contractors works, delivery/Supply to site, storing and handling at site, training of personnel at site for operation and maintenance and carrying out performance tests at site to the satisfaction of the GSCL.
- b) The Bidder/Contractor shall supply, install, testing, commissioning and maintain the Building Automation System (BAS) including provision of all necessary hardware, software and relevant spares.
- c) The Bidder/Contractor shall provide all interface components for automation system including, sensors, transducers etc. to interface with other mechanical & electrical equipment unless specified otherwise in this contract. Normally, the dry contacts shall be made available, but in the event of these not being available, the Bidder/Contractor may be required to provide the necessary paraphernalia. The terminations in the other services panels shall be in scope of respective Bidder/Contractor.
- d) It shall be the responsibility of Bidder/Contractor to perform all checks on wiring, sensor and actuator mounting for trouble-free operation of the equipment.
- e) It shall be responsibility of Bidder/Contractor to in close coordination with services Bidder/Contractor so that desired results are obtained along with complete monitoring of various systems.
- f) Cables for the integration of the system shall run in separate (MS/GI) conduits/raceway to be provided and installed by the Bidder/Contractor.
- g) Proper operation and maintenance of the system shall be responsibility of the Bidder/Contractor and shall include debugging and calibration of each component in the entire system. Maintenance Software package also should be included in the scope.
- h) Bidder/Contractor should obtain all technical details of each equipment which are being controlled / monitored and program the maintenance software as per the manufacturer's recommendations.
- i) No claim for extra items shall be entertained for installation / commissioning of the system. All works in connection with completion of the system shall be in scope of this tender. The tenderer shall take into its scope, price for all works and approvals in connection with installation of the BAS System from government as well as statutory bodies.

**Besides the above, general scope of work shall also include the following:**

- j) Supply & installation of all necessary BAS control and monitoring outstations.
- k) Supply and installation of all BAS field controls cabling including local area networks.
- l) Supply and installation of field interface cabling between all equipment and the BAS System.



- m) Identification of all field cabling from the motor control panels at both ends of each core, and in junction boxes using the same numbering as used for associated outgoing enclosure terminal.
- n) Supply and installation of controls for temperature, humidity and pressure detectors, thermostats, flow switches and differential pressure switches, etc. associated with the BMS.
- o) Ensure all control devices are positioned such that maximum stability of control for each system can be achieved.
- p) Supply and fitting of necessary clips, hangers and supports for all averaging element detectors and for serpentine them across the ducts.
- q) GI trunking/ GI Trays with GI supports wherever more than 6 Nos. conduits/cables are to be terminated at any point. More than 6 Nos. Armoured cables should not be saddled directly in to wall /ceiling and cable tray/trunking should be used for the same.

### **7.3 Detailed Design Submittals:**

- a) Literature to be furnished by the successful tenderer.
- b) Besides furnishing the information called for in Technical data, tenderers shall submit literature with specifications and all relevant data. Bidder shall submit system configuration drawing, write-up on the system and its features, clause by clause confirmation to the specification and data sheets and catalogues for the proposed make and models of all the components of the system. The UPS load corresponding to the BMS equipment shall be indicated in the bid. All BMS equipment is to be covered by the UPS.
- c) On the Award of Contract, the manufacturer shall submit the following for approval.
  - i) Shop drawing on each piece of equipment provided in accordance with the specification. – Dimensional data sheet, wiring diagram, foundation detailed drawings etc.
  - ii) Brief description of the system/equipment offered.
  - iii) Installation, Operation and Maintenance data sheet/manuals.
  - iv) Compliance statement with Tender requirements.
- d) Drawings and Documents: All works shall be carried out on the basis of approved drawings. Drawings furnished shall include, but not be limited to
  - i) Schematic diagram
  - ii) Layout Diagrams
  - iii) Drawings for control panels.

### **7.4 Ambient Conditions**

All controls shall be capable of operating in ambient conditions varying between 0-50 °C and 90% RH non-condensing.

### **7.5 Cable Entry**

All control devices are to be provided with entry provision, with suitable glands/sealing.

### **7.6 Weather Protection**

All devices located outdoors without any canopy shall be provided with weatherproof housing. As far as possible, canopy should be provided in such locations to avoid water entry in to devices.

### **7.7 System Wiring**

All cables shall be STP Braided copper conductor armoured type. Cable end shall be provided with proper glanding. Multiple runs of cable at the same location shall be laid in cable trays/Surface with cable cleats / ties for proper cable dressing.

### **7.8 General**

- a) Prior to laying and fixing of cables, the Bidder/Contractor shall carefully examine & then execute. Any discrepancy found in the drawings shall be brought to the notice of Engineer-In-Charge. Any modifications suggested by the Bidder/Contractor shall be got approved by the Engineer-In-Charge before the actual laying of cables is commenced.
- b) The routing of cables shall be only through the common areas / utilities rooms of the building except for BMS equipment is installed within the occupied areas. Routing through the occupied areas is not permitted. Where this guideline causes the cable distances to be large, field devices and DDC controller I/O points shall be selected for operating using 4 – 20 mA / potential free contacts. The cables shall be brought to the site in original packing.

### **7.9 E rection & Checking at Site**

- a) All work at site is to be carried out in such a manner as not to obstruct the operations of other agencies.
- b) The execution of all works included in this Contract is to be supervised by a sufficient number of qualified representatives.

- c) On completion of the works, the site is to be left neat and tidy to the satisfaction of the Engineer-In-Charge.

## **7.10 Testing & Commissioning - IBMS**

### **7.10.1 General**

- i) Testing shall mean that all the systems efficiently meet the performance specified in operation. The systems shall be tested in the presence of the Engineer-In-Charge who requires at least two full working days prior notice to enable him to attend.
- ii) The EPC Bidder/Contractor shall arrange for the representatives of any of his own Bidder/Contractors specialties to be in attendance.
- iii) It shall be the responsibility of the Bidder/Contractor to arrange all necessary testing equipment, instruments newly calibrated, etc. Provision of all testing equipment and the appropriately skilled labour shall have been included in the Tender Price.
- iv) The Engineer-In-Charge will order that the fault be corrected and re-tested prior to acceptance. All fees connected with testing of equipment payable by the Bidder/Contractor to any of the relevant Government Authority shall be borne by the Bidder/Contractor.

### **7.10.2 Commissioning Test**

- i) The complete installation or any part thereof shall be tested, both before and after being commissioned to check the performance in operation. All fees connected with testing of equipment payable by the Bidder/Contractor to any of the relevant Government Authority or expert from the supplier shall have been included in the Tender Sum.
- ii) The Bidder/Contractor shall be represented by a competent person approved by the Engineer-In-Charge during the whole of the period required for the tests.
- iii) All materials and equipment supplied or erected under this Contract which failed in the tests shall be replaced or rectified at once by the Bidder/Contractor without any additional cost.
- iv) The Bidder/Contractor shall supply all necessary instruments, apparatus, connections, skilled and unskilled labour required for the tests to be conducted in the presence of the Engineer-In-Charge, make accurate records of all tests carried out and furnish to the Engineer-In-Charge with six (6) copies of the Test certificates and Schedule of Tests Results in approved form.
- v) The Bidder/Contractor shall prepare a detailed and comprehensive check list for use during commissioning and testing. At least for (2) months prior to the start of commissioning, the Bidder/Contractor shall commence gathering

information required for this check list. Two (1) months prior to the start of commissioning, the Bidder/Contractor shall submit to the Engineer-In-Charge his proposed check list for approval as follows :-

- a. Ensure that all items that should be checked are included.
  - b. Produce a permanent record of the commissioning checks carried out.
- vi) Accordingly, the check list must be built from information contained in the Specification, from manufacturer's and Bidder/Contractors installation and commissioning of similar equipments and systems.
- vii) The detail of the check list must be such that it can be completed with a reading or a tick which means that every device has been checked

#### **7.11 System Description, Hardware & Software and Functional Requirement**

- a) The Building Management System (BMS) shall use an open architecture and fully support a multi-vendor environment. To accomplish this effectively, the BMS shall support open communication protocol standards and integrate a wide variety of third-party devices and applications. The system shall be designed for use on the Internet, or intranets using off the shelf, industry standard technology compatible with other owner provided networks.
- b) The Building Management System shall consist of the following:
  - i) Standalone Network Automation / Supervisory Controller(s)
  - ii) Field Level DDC Controller(s)
  - iii) Input/ Output Module(s)
  - iv) Local Display Device(s)
  - v) Portable Operator's Terminal(s)
  - vi) Distributed User Interface(s)
  - vii) Network processing, data storage and communications equipment
  - viii) Other components required for a complete and working BMS
- c) The system shall be modular in nature and shall permit expansion of both capacity and functionality through the addition of sensors, actuators, controllers and operator devices, while re-using existing controls equipment.
- d) Soft points count shall be unlimited in the software. If any of the vendor have the limitation then the installing software shall have minimum 50000 nos of soft point licenses to provide the future expansion without any extra cost implication.
- e) The supplied software must support minimum 10 Nos of Concurrent Users
- f) System architectural design shall eliminate dependence upon any single device for alarm reporting and control execution.

- g) The failure of any single component or network connection shall not interrupt the execution of control strategies at other operational devices.
- h) The System shall maintain all settings and overrides through a system reboot.
- i) System architectural design shall eliminate dependence upon any single device for alarm reporting and control execution.
- j) The System shall comply with (UL) 864 (UUKL) Ninth Edition Smoke Control Listing including the UL 864 Ninth Edition Standard for Control Units and Accessories for Fire Alarm System

#### **7.11.1 Central Stations Hardware**

Supply, installation, testing & commissioning of the control stations comprising of Personal computers (PC) providing high level operator interface with the system. The terminals shall be capable of providing the operator with the facility for remote system interrogation, control, retrieval/storage of logged data, annunciation of alarms and reports, analysis of recorded data and the formatting of management reports.

#### **7.11.2 Dedicated Web Based User Interface**

- k) All features and functions of the dedicated user interface previously defined in this document shall be available on any computer connected directly or via a wide area or virtual private network (WAN/VPN) to the automation network and conforming to the following specifications.
- l) The software shall run on the Microsoft Internet Explorer (8.0 or higher) browser supporting the following functions:
  - Configuration
  - Commissioning
  - Data Archiving
  - Monitoring
  - Commanding
  - System Diagnostics
- m) The following user programmes must be processed by the Control Station
  - i) **Operating functions :**
    - a. Via graphic management schematics with dynamic display of actual status information.
    - b. Manual control of parameters and status variables of the electrical and mechanical plant.
    - c. Manual switch of programs which are not part of progress routines.
  - ii) **Monitoring functions :**
    - a. Automatic monitoring of connected plant and equipment

- b. Automatic monitoring of the system (idle or operation)
- iii) **Data Visualization functions :**
  - a. Individual processing of operating data for Building Management.
  - b. Comfort chart data for temperature / humidity using psychometric charts
- iv) **In standardized form for :**
  - a. Trend reports
  - b. Consumer statistics
  - c. Fault statistics
  - d. Maintenance management
- v) **Display functions :**
  - a. For the representation and display of operating data and management information in alphanumeric and graphic form.
- vi) **Management functions :**
  - a. For optimization of energy consumption.
  - b. For rational use of personnel
- vii) **Access control functions :**
  - a. Different operating levels for all information and all data by way of code word or user key.
- viii) **Commissioning functions :**
  - a. For system specific software of the field stations and the management system
  - b. Downloading the system specific software to the DDC units.
  - c. Testing of the software in connection with electrical and mechanical plant.
  - d. Automatic and periodic storage of all system data.
- ix) **Test functions :**
  - a. Automatic and continuously running test functions for system tests (hardware and operating software) and management system configuration (communication)
  - b. Test tools for individual hardware and software components which can be activated manually.

- c. Self-test functions for individual system components which can be activated manually.

### **7.11.3 Operator Interface**

All communications between the operator and the system shall be in clear language, without reference to special code or codes. Generation and editing of software shall be via clear English language menus.

### **7.11.4 Password Access**

- n) None of the features of the Operators Panel shall be accessible without the user first being required to log on by entering a password.
- o) Alpha numeric passwords of up to 15 characters shall be available and definable by individual operators.
- p) It shall be possible to grant or deny access to any terminal and/or functions for individual user. The ability to use this feature itself shall also be definable.
- q) It shall also be possible to grant or deny access to individual points or groups of points by function or type.
- r) It shall also be possible to define a timeout value for individual user. Automatic log-off of the operator shall occur if no keyboard or mouse activity is detected during this timeout period. It shall also be possible to allocate an infinite timeout.
- s) A log of at least previous 100 users shall be available at each control station. A record of the user's name, the time and date of log ON and log OFF shall be available from this file.
- t) Password summary shall be available to the operators with the highest level of access. The summary shall display all passwords and their associated parameters.
- u) Password data base shall be stored in multiple locations in an encrypted form so that the failure of any one device shall not make the system inoperative.

### **7.11.5 Direct Digital Controller (DDC)**

#### **UI Listed and BTL/LONMARK IP-852 Certified Direct Digital Controller (DDC) Hardware Requirement :**

- a) The DDC Controller shall be a fully user-programmable, digital controller that communicates via BACnet MS/TP protocol. The DDC Controller shall support BACnet Standard MS/TP Bus Protocol ASHRAE SSPC-135, Clause 9 on the controller network.
- b) The DDC Controller shall be BACnet Testing Labs (BTL) certified and carry the BTL Label.
- c) The DDC Controller shall be tested and certified as a BACnet Application Specific Controller (B-ASC).

- d) A BACnet Protocol Implementation Conformance Statement shall be provided for the DDC Controller.
- e) The Conformance Statement shall be submitted 10 days prior to bidding.
- i) The DDC Controller shall employ a finite state control engine to eliminate unnecessary conflict between control functions at crossover points in their operational sequences. Suppliers using non-state based DDC shall provide separate control strategy diagrams for all controlled functions in their submittals.
- ii) Controllers shall be factory programmed with a continuous adaptive tuning algorithm that senses changes in the physical environment and continually adjusts loop tuning parameters appropriately. Controllers that require manual tuning of loops or perform automatic tuning on command only shall not be acceptable. The DDC Controller shall be assembled in a plenum-rated plastic housing with flammability rated to UL94-5VB.
- f) The DDC Controller shall include troubleshooting LED indicators to identify the following conditions:
- Power On
  - Power Off
  - Download or Startup in progress, not ready for normal operation
  - No Faults
  - Device Fault
  - Field Controller Bus - Normal Data Transmission
  - Field Controller Bus - No Data Transmission
  - Field Controller Bus - No Communication
  - Sensor-Actuator Bus - Normal Data Transmission
  - Sensor-Actuator Bus - No Data Transmission
  - Sensor-Actuator Bus - No Communication
- g) The DDC Controller shall accommodate the direct wiring of analog and binary I/O field points.
- h) The DDC Controller shall support the following types of inputs and outputs:
- i) Universal Inputs - shall be configured to monitor any of the following:
- Analog Input, Voltage Mode
  - Analog Input, Current Mode
  - Analog Input, Resistive Mode
  - Binary Input, Dry Contact Maintained Mode
  - Binary Input, Pulse Counter Mode
- j) Binary Inputs - shall be configured to monitor either of the following:
- Dry Contact Maintained Mode



- Pulse Counter Mode
- k) Analog Outputs - shall be configured to output either of the following
- Analog Output, Voltage Mode
  - Analog Output, current Mode
- l) Binary Outputs - shall output the following:
- 24 VAC Triac
- m) Configurable Outputs - shall be capable of the following:
- Analog Output, Voltage Mode
  - Binary Output Mode
- n) The DDC Controller shall have the ability to reside on a Field Controller Bus (FC Bus).
- i) The FC Bus shall be a Master-Slave/Token-Passing (MS/TP) Bus supporting BACnet Standard protocol SSPC-135, Clause 9.
  - ii) The FC Bus shall support communications between the DDC Controller and the Supervisory Controller.
  - iii) The FC Bus shall also support Input/ Output Module communications with the DDC Controller and with the Supervisory Controller.
  - iv) The FC Bus shall support a minimum of 100 IOMs and DDC Controllers in any combination.
  - v) The FC Bus shall operate at a maximum distance of 15,000 Ft. between the DDC Controller and the furthest connected device.
  - vi) The DDC Controller shall have the ability to monitor and control a network of sensors and actuators over a Sensor-Actuator Bus (SA Bus).
  - vii) The SA Bus shall be a Master-Slave/Token-Passing (MS/TP) Bus supporting BACnet Standard Protocol SSPC-135, Clause 9.
  - viii) The SA Bus shall support a minimum of 10 devices per trunk.
  - ix) The SA Bus shall operate at a maximum distance of 1,200 Ft. between the DDC Controller and the furthest connected device.

## **7.12 Field Devices**

### **7.12.1 Electric And Electronic Controls Related Equipment**

- i) All controls shall be capable of operating in ambient conditions varying between 0-50 deg. C and 90% RH non-condensing.
- ii) All Control devices shall have a 20 mm conduit knockout. Alternatively, they shall be supplied with adaptors for 20 mm conduit.

### 7.12.2 Temperature Sensor

Temperature sensors for space, pipes and ducts, shall be of the Resistance Temperature detector (RTD) type or thermistor. These shall be two wire type and shall conform to the following specifications :

- i) Immersion sensors shall be high accuracy type with a high resistance versus temperature change. The accuracy shall be at least  $\pm 0.35$  degrees F and sensitivity of at least 2 ohm/F.
- ii) Immersion sensors shall be provided with separate stainless steel thermo well. These shall be manufactured from bar stock with hydrostatic pressure rating of at least 10 kgf/cm<sup>2</sup>.
- iii) The connection to the pipe shall be screwed  $\frac{3}{4}$  inch NPT (M). An aluminum sleeve shall be provided to ensure proper heat transfer from the well to the sensor. Terminations to be provided on the head. Flying leads shall not be acceptable.
- iv) The sensor housing shall plug into the base so that the same can be easily removed without disturbing the wiring connections.
- v) Duct temperature sensors shall be with rigid stem and of averaging type. These shall be suitable for duct installation.
- vi) Outdoor air temperature sensor shall be provided with a sun shield.
- vii) The sensors shall not be mounted near any heat source such as windows, electrical appliances etc.
- viii) The temperature sensors may be of any of the following types :
  - a. PT 100, PT 1000, PT 3000
  - b. NI 100, NI 1000
  - c. Balco 500.
  - d. Thermistor

### 7.12.3 Humidity Sensor

Space and duct humidity sensors shall be of capacitance type with an effective sensing range of 10% to 90% RH. Accuracy shall be +/- 3% or better. Duct mounted humidity sensors shall be provided with a sampling chamber. Wall mounted sensors shall be provided with a housing. The sensor housing shall plug into the base so that the same can be easily removed without disturbing the wiring connections. The sensors shall not be mounted near any heat source such as windows, electrical appliances etc.

#### **7.12.4 Pressure Transmitter/Differential Pressure Sensor For Water**

Pressure transmitters shall be piezo-electric type or diaphragm type. Output shall be 4-20mA or 0-10V DC and the range as specified in the data sheet depending on the line pressure. Power supply shall be either 24 V AC, 24 V DC or 230 V AC. Connection shall be as per manufacturer's standards. The pressure detector shall be capable of withstanding a hydraulic test pressure of twice the working pressure. The set point shall fall within 40%-70% of the sensing range and detector shall have sensitivity such that change of 1.5% from the stabilized condition shall cause modulation of the corrective element. The sensor must be pressure compensated for a medium temperature of -10 °C to 60 °C with ambient ranging between 0 °C to 50 °C.

#### **7.12.5 Differential Pressure Switch For Pipe Work**

These shall be used to measure pressure differential across suction and discharge of pumps. Switch shall be ON with increase in differential. Housing for these shall be weather proof with IP 54 or better protection. The pressure switch shall be capable of withstanding a hydraulic test pressure of 1.5 times the working pressure. The set point shall fall in 40-70% of the scale range and shall have differentials adjustable over 10%-30% of the scale range. The switches shall be provided with site adjustable scale and with 2 NO/NC contacts.

#### **7.12.6 Differential Pressure Switch for Air Systems**

- i) These shall be diaphragm operated. Switches shall be supplied with air connections permitting their use as static or differential pressure switches.
- ii) The switch shall be of differential pressure type complete with connecting tube and metal bends for connections to the duct. The housing shall be IP 54 rated. The pressure switches shall be available in minimum of 3 ranges suitable for applications like Air flow proving, dirty filter, etc. The set point shall be concealed type. The contact shall be SPDT type.
- iii) The switch shall be supplied suitable for wall mounting on ducts in any plane. It should be mounted in such a way that the condensation flow out of the sensing tips. Proper adaptor shall be provided for the cables.
- iv) The switches shall be provided with site adjustable scale and with 2 NO/NC contacts.

#### **7.12.7 Level Switch**

The level switches shall have to meet the following requirement:

- a. Type : Float Type/Capacitance type/Conductivity type
- b. Mounting : To suit application.
- c. Connection : Flanged ANSI 150 lbs RF Carbon steel
- d. Float material : 316 SS

- e. Stem Material : 316 SS
- f. Output : 2 NO, 2 NC potential free
- g. Switch Enclosure : IP 55

### 7.13 Mode of Measurement

#### Signal Cable

The cabling running between DDC controllers to the field devices shall be termed as signal cabling. .

#### Communication Cable

The cabling running between the system integration units to the DDC controllers shall be defined as communication cable.

### 7.14 Signal, Power & Communication Cable

The signal cable shall be of the following specifications:

- i) Wire : Annealed Tinned Copper
- ii) Size : 1 sq. mm, Multi Strand
- iii) No. of conductors : Two (One pair) shielded
- iv) Type : STP Braided Armoured Cable
- v) Colour : Black and Red

### 7.15 Communication Cable

The communication cable shall be of the following specifications:

- i) Wire : Annealed Tinned Copper, twisted pair
- ii) Size : 1.5 sq. mm, Multi Strand shielded
- iii) No. of conductors : One pair (2 conductor)
- iv) Shielding : Overall beld foil Aluminium polyester shield.
- v) Type : STP Braided Armoured Cable Jacket
- vi) Colour : Black and Red, Black and White)

### 7.16 Integeration

BMS shall be such integrate so that it become one complete system.

## 7.17 Approved List Of Makes For Building Management System

S. No	ITEMS	MAKES
1	CENTRAL CONTROL STATION	Lenovo / IBM / HP / DELL
2	BUILDING MANAGEMENT SYSTEM WEB-BASED SERVER SOFTWARE	Honeywell (Comfort Point)/ Johnson Controls Metasys / ALC / L&T
4	PROGRAMMABLE & APPLICATION SPECIFIC CONTROLLER (DDC)	Honeywell (Comfort Point)/ Johnson Controls Metasys / ALC / L&T
4	WEB SERVER ENGINES (NETWORK / SUPERVISORY CONTROLLERS)	Honeywell (Comfort Point)/ Johnson Controls Metasys / ALC / L&T
5	INTEGRATORS	Honeywell (Comfort Point)/ Johnson Controls Metasys / ALC / L&T
<b>6</b>	<b>SENSORS AND FIELD DEVICES</b>	
<b>a</b>	Immersion type temperature sensors	Honeywell/Johnson Controls/L&T/ALC
<b>b</b>	Differential Pressure Switch (blowers & Filters & Pump)	Honeywell/Johnson Controls/L&T/ALC
<b>c</b>	Duct mount temperature & RH sensor	Honeywell/Johnson Controls/L&T/ALC
<b>d</b>	Damper Actuator	Honeywell/Johnson Controls/L&T/ALC I
<b>e</b>	CO Sensor	JohnsonControls/Honeywell/Greystone/GE/ MSR(Germany)/ Dwyer/Omnicon
<b>f</b>	CO2 Sensor	Johnson Controls//Honeywell/ MSR(Germany)/ Dwyer
<b>g</b>	Current Relay	Johnson Controls/Honeywell/Kele/ Sentry
<b>h</b>	Water level Switch / Transmitter	Johnson Controls/ Sanitech / Honeywell/ Filpro/ Sontay/ Veksler
<b>i</b>	Water Pressure Sensor	Johnson Controls/Omnicon /Honeywell/Kele
<b>j</b>	Outside Air Temperature/ RH Sensor	Honeywell/ Invensys/ Johnson Controls / Dwyer
<b>7</b>	<b>WIRING &amp; CONDUITING</b>	
<b>a</b>	Communication Cables / Signal Cable/ Control Cable	Teleflex / Skytone/Polycab/Fusion Polymer/ Excel / Bonton
<b>b</b>	MS/GI/ PVC conduits	BEC / AKG/ Precision / NIC / Steelcraft
<b>c</b>	CAT 6 cable	Leviton/ Amp / Panduit/ Systimax

## 8.0 AUDIO VIDEO EQUIPMENT FOR THE CONFERENCE ROOM

### 8.1 Projector Specifications and Features

Components	Item Specifications
Brightness:	5,500 Lumens
Resolution:	Full HD 1080x1920 pixel
Aspect Ratio:	1.85:1 (Quad HD)
Video Modes:	720p, 1080i, 1080p/60, 1080p/24, 1080p/50,
Data Modes:	MAX 4096x2160
Panel & Interface	HDMI , RS232 (DB-9pin), Network (RJ-45) & 12-Volt Trigger
Connection Port	VGA, HDMI, USB, SD card for various uses like gaming etc.
Lamp Life(eco-mode):	6,000 hours
Lamp Type:	UHP
Display Type:	SXRD (3)
Standard Zoom Lens:	Powered, 2.06:1
Standard Lens Focus:	Powered
Optional Lenses:	No
Lens Shift:	Horz & Vert
Throw Dist (m):	5.0 - 6.1
Image Size(cm):	203 - 508
Throw Ratio(D:W):	1.38:1 - 2.82:1
Voltage:	100V - 240V AC

## 8.2 Projector Screen (Motorized) Specifications and Features

Components	Item Specifications
Fabric	Seamless compound multi-layers diffuse reflection fabric.

Components	Item Specifications
Motor	Tubular ( with smooth & quieter operation)
Black Drop	600 mm
Viewing Area	6000mm(W) x 4500mm(H)
Overall Size	6390mm x 5412mm
Casing	Light and high-intensity Aluminum alloy
Roller	High strength alloy aluminum roller (~148mm diameter)
Position Adjustment	Screen fabric rod adjustment for wrinkle free & improved fabric stiffness.
Level camber	≤ 0.05%
End Cap	234 mm x 219 mm.
Power	≤ 270 W
Weight	≤ 155 Kgs.
Control	In-line switches and wireless remote
Authorization certificates	ISO-9001, UL, RoHS, UKAS, member InfoComm international
Power Synchro Relay	To create a synchronized control with projector i.e. when the projector is turned on, the projection screen will automatically lower and when the projector is off, the projection screen will automatically retract.
Warranty	1 year for any manufacturing defects

### 8.3 Wireless Microphones & Goose Neck Wireless Mic with Stand

This system shall be with all associated components with wireless Mic controllers.

S.No	Features	Minimum Configuration	Compliance (Y/N)
1	THD, total harmonic distortion	typ. 0.1 %	
2	Power consumption	350 mA	
3	Storage temperature	-20 °C to 70 °C, (-4 °F to 158 °F)	
4	Operating temperature	0 °C to 40 °C (14 °F to 131 °F)	
5	Signal-to-noise ratio	> 90 dB(A)	

S.No	Features	Minimum Configuration	Compliance (Y/N)
6	Goose neck length	40 cm	
7	RF output power	adaptive, up to 250 mW (country-specific)	
8	Operating time	typ. 10h with BA 40	
9	Power supply	12 V DC	
10	Audio output level (balanced)	max. -18 dBu, typ. -24 dBu	
11	Audio output level (unbalanced)	max. +6 dBu	
12	Dynamic range	> 120 dB(A)	
13	Frequency range	a) 1,880 to 1,900 MHz b) 1,920 to 1,930 MHz c) 1,893 to 1,906 MHz	
14	Input impedance	30 k $\Omega$	
15	Max. Input voltage	1.7 V RMS	
16	RF sensitivity	< -90 dBm	
17	Sampling rates	24 bit/48 kHz	
18	Connection	Audio Out: XLR 3M	
19	Audio Out: 2 x RCA	Network: RJ 45	
20	XLR Microphone Inputs	XLR 5F	

#### 8.4 Sound Speakers Set – For Projectors

STAGE MONITOR SPEAKER	
Features	Minimum Configuration Requirements
Impedance:	8Ohm
Frequency Response:	70Hz-18Khz
Power:	200W
Sensitivity	95dB
Override Angle	(H)90 degree (V)45 degree
Treble	34 Titanium Coating Treble
Bass	190 Magnetic 12 Inch bass
Enclosure Material	15mmHigh Density board



## 8.5 8 IN 8 Out DSP – Digital Sound Processor

DIGITAL SOUND PROCESSORS	
Features	Minimum Configuration Requirements
Sampling Frequency	96 KHz
Processors	332-bit DSP processor, 24-bit A / D and D / A conversion.
Power Microphone/Circuit Input & Output	16-channel Phantom Power Microphone/circuit input, 16- channel circuit Output;
Control Input & Output	8- channel External control input and 8- channel Logic output
Dynamic Range	109, A-Weighted
THD + Noise	0.00%
Channel Separation	91dB@20Hz-20kHz, re+4dBu
CMRR	≥85dB@1kHz, re+4dBu
Frequency Response	±0.03dB 20Hz-20kHz

## 8.6 Gooseneck Microphone

GOOSENECK MICROPHONES	
Features	Minimum Configuration Requirements
Type	Wireless digital Handheld Microphone with 18 or more channel, super cardioid pickup pattern
RF Output	80 mW or more,
Frequency Response –	50 Hz – 18kHz
SPL	120dB
Sensitivity	-47dB

## 8.7 Presentation VGA Switcher

VGA SWITCHERS	
Features	Minimum Configuration Requirements

<b>VGA SWITCHERS</b>	
<b>Features</b>	<b>Minimum Configuration Requirements</b>
Module	4x2 VGA
Input	4 VGA
Output	2 VGA
Bandwidth	400MHz
K Factor	< 0.05%
S/N Ratio	75dB
Controls	22 front panel buttons, RS-232, RS-485, Ethernet
Scaling	Switcher should have either Built in Scaling Facility or Additional Scalar need to take for HDMI Output

**SCHEDULE C – DATA SHEETS**

**ELECTRICAL WORKS – DATASHEET**

1) **COMPACT SUBSTATION**

	SL. NO.	ITEM	UNIT	TECHNICAL PARTICULARS
<b>GENERAL</b>	<b>1.0</b>	<b>ENCLOSURE SPECIFICATIONS</b>		
	1.1.	Make		
	1.2.	Applicable Standards		
	1.3.	Rated maximum power of substation	kVA	
	1.4.	Ambient Temperature	°C	
	1.5.	Type of Ventilation for		
		a) Normal Condition		
		b) Hot Condition		
	1.6.	Compartmentalized		<input type="checkbox"/> Yes <input type="checkbox"/> No
	1.7.	Fault level	kA, sec	
	1.8.	Rated temperature enclosure class		
	1.9.	Internal Arc withstand level		
	1.10.	Degree of protection		
		a) MV & LV compartment		
		b) Transformer compartment		
1.11.	Enclosure material			
1.12.	Thickness of sheet	mm		
1.13.	Paint colour & finish			
1.14.	Total dimensions of Compact Substation (H X W X D)	mm		
1.15.	Weight	Kg		
	<b>2.0</b>	<b>CIRCUIT BREAKER</b>		
	2.1.	Type of circuit breaker		
	2.2.	Rated current	A	
	2.3.	Nominal system voltage	kV	
	2.4.	Maximum continuous voltage	kV	
	2.5.	Power frequency withstand (one minute) voltage		
		a) Short circuit withstand	kV	
		b) Momentary withstand	kV	

SL. NO.	ITEM	UNIT	TECHNICAL PARTICULARS
2.6.	Impulse 1.2/50micro sec withstand voltage	kV	
2.7.	Trip coil consumption at rated voltage	Watt	
2.8.	Type of closing mechanism		
2.9.	Spring charging mechanism		
2.10.	Spring charging motor power rating & voltage	Watt, Volt	
<b>3.0</b>	<b>BUSBAR</b>		
3.1.	Material		
3.2.	Busbar cross section	Sq.mm	
3.3.	Continuous current rating under site condition	A	
3.4.	Busbar insulation		
3.5.	Minimum clearance		
	c) Phase to phase	mm	
	d) Phase to earth	mm	
<b>4.0</b>	<b>CURRENT TRANSFORMERS METERING &amp; PROTECTION</b>		
4.1.	Type (Bar/ Wound/ Any other)		
4.2.	Make		
4.3.	Class of insulation		
4.4.	Ratio		
4.5.	Rated VA burden		
4.6.	Accuracy class		
<b>5.0</b>	<b>VOLTAGE TRANSFORMERS</b>		
5.1.	Type		
5.2.	Make		
5.3.	Ratio		
5.4.	Accuracy		
5.5.	Type of insulation		
<b>6.0</b>	<b>INDICATING METERS</b>		
6.1.	Make		
6.2.	Type		

SL. NO.	ITEM	UNIT	TECHNICAL PARTICULARS
6.3.	Size		
6.4.	Mounting, flush type or other		
6.5.	Accuracy		
6.6.	Range		
6.7.	VA burden for each type		
<b>7.0</b>	<b>PROTECTION RELAYS</b>		<input type="checkbox"/> Electromechanical <input type="checkbox"/> Solid state <input type="checkbox"/> Numerical
7.1.	Make		
7.2.	Inverse time over-current relay		
7.3.	Instantaneous over-current relay		
7.4.	Thermal overload protection relay		
7.5.	Earth leakage relay for use with core balance CT		
7.6.	Earth fault relay for use in the residual circuit of main CTs		
<b>8.0</b>	<b>TRANSFORMER PARTICULARS</b>		
8.1.	Make		
8.2.	Type		
8.3.	Full load rating	kVA	
8.4.	Type of cooling		
8.5.	Rated percentage impedance	%	
8.6.	Winding connections		
	a) HV		
	b) LV		
	c) Vector group		
8.7.	Tap changer		On load / off load
	a) Total tapping range	%	
	b) Tapping steps		
	c) On HV/LV winding		
8.8.	Method of earthing - LV		
8.9.	Windings material		
8.10.	Type of insulation		
8.11.	1.2/ 50 micro impulse withstand		
	a) HV	kV	

	SL. NO.	ITEM	UNIT	TECHNICAL PARTICULARS
		b) LV	kV	
	8.12.	One minute power frequency withstand voltage		
		a) HV	kV	
		b) LV	kV	
	8.13.	Maximum temperature rise of windings	°C	
	8.14.	Max guaranteed load loss at rated current at max winding temperature For ONAN / ONAF / AN / AF	kW	
	8.15.	No load losses at 100% rated voltage and frequency	kW	
	8.16.	Cooling equipment power loss	kW	
<b>TRANSFORMER</b>	8.17.	Magnetization current at rated voltage and frequency in percent of full load current	%	
	8.18.	Efficiency at max winding temperature at full load, at UPF and 0.8 PF lag at 75% load, at UPF and 0.8 PF lag at 50% load, at UPF and 0.8 PF lag	%	
	9.19.	Noise	dB	
	8.20.	Weight	Kg	
<b>LV</b>	<b>9.0</b>	<b>CIRCUIT BREAKER</b>		
	9.1.	Circuit Breaker Type (Air break and / MCCB)		
	9.2.	Rated voltage	V	
	9.3.	Rated current	A	
	9.4.	Rated symmetrical breaking current at rated voltage (Indicate power factor)	kA at PF	
	9.5.	Rated short time withstand rating for 1 sec (For MCCB, BIDDER to indicate the time)	kA	
	9.6.	Operating mechanism type		
	9.7.	Rated operating duty		
	9.8.	Relationship between ICU, ICS & ICW	%	
	9.9.	Have electrical and mechanical anti-pumping features been provided	Yes / No	
	<b>11.0</b>	<b>FUSE</b>		
	11.1.	Make		
	11.2.	Type		
11.3.	Rated voltage	V		



	SL. NO.	ITEM	UNIT	TECHNICAL PARTICULARS
	<b>12.0</b>	<b>BUSBARS</b>		
	12.1.	Material		
	12.2.	Busbar cross section	Sq.mm	PH :                      Neutral :
	12.3.	Continuous current rating under site conditions	A	
	12.4.	Busbar insulation		
	12.5.	Minimum clearance		
		a) Phase to phase	mm	
		b) Phase to earth	mm	
	12.6.	Short time rating (One Sec.)	kA	
	12.7.	Momentary rating (Peak)	kA	
	<b>13.0</b>	<b>CURRENT TRANSFORMERS</b>		
	13.1.	Type		
	13.2.	Make		
	13.3.	Ratio		
	13.4.	Accuracy		
	<b>14.0</b>	<b>VOLTAGE TRANSFORMERS</b>		
	14.1.	Make		
	14.2.	Ratio		
	14.3.	Accuracy		
	14.4.	Output per phase	VA	
	14.5.	Class of insulation		
	<b>15.0</b>	<b>INDICATING METERS</b>		
	15.1.	Make		
	15.2.	Type		
	15.3.	Size		
	15.4.	Mounting, flush type or other		
	15.5.	Accuracy		
	15.6.	Range		
	15.7.	VA burden for each type		
<b>MISCELLAN</b>	16.0	DC SYSTEM		
	17.0	AUTOMATIC POWER FACTOR CONTROL (APFC) UNIT		

	SL. NO.	ITEM	UNIT	TECHNICAL PARTICULARS
	18.0	SPARES		
	19.0	COMPLIANCE WITH SPECIFICATION		

## 2) 415V METAL ENCLOSED SWITCHGEAR

Sr. No	Description	Unit	Technical Particulars
1	<b>415 V Switchgear and Bus bar Ratings</b>		
(a)	Rated voltage phase and frequency		
(b)	System Neutral Earthing		
(c)	Maximum system voltage		
(d)	One minute power frequency voltage		
	i) Power circuits		
	ii) Control circuits		
	iii) Aux. Circuits connected to Sec of CTS		
(e)	Continuous current rating of Bus bars under site reference Ambient Temperature and type		
(f)	Bus bar insulation		
(g)	Reference Ambient Temperature		
(h)	Maximum Temperature of Bus bars, Droppers and Contacts at Continuous current rating under site ambient temperature		
(i)	Short Circuit current withstand for Bus bars and droppers		
	(i) Short time 1 sec		
	(ii) Dynamic Rating		
2	<b>Switchgear Constructional Requirements</b>		
(a)	Type of Construction		

Sr. No	Description	Unit	Technical Particulars
(b)	Thickness of sheet steel (i) Frame, Frame enclosures, doors, covers and partitions		
(d)	Colour finish shade		
(e)	Earthing bus	Material	
		Size	
	Earthing conductor	Material	
		Size	
(g)	Minimum clearances in air of live parts (i) Phase to Phase		
	(ii) Phase to Earth		
(h)	Cable entry to cubicles		
<b>3</b>	<b>Instrumentation Transformers</b>		
(a)	Current transformer		
	(i) Ratio		
	(ii) Burden		
	(iii) Accuracy Class		
(b)	Voltage transformer		
	(i) Ratio		
	(ii) Burden		
	(iii) Accuracy Class		
<b>4</b>	<b>Type of Starter for MCC Panel</b>		

### 3) LV CAPACITOR PANEL

S. N.	Description	Unit	Technical Particulars
i	General		
(a)	Make		
(b)	Rated Capacity	kVAR	
(c)	Rated voltage	V	
(d)	Rated frequency and phases		

S. N.	Description	Unit	Technical Particulars
(e)	Ambient temperature	° C	
(f)	Cable gland required		
(g)	Type of cable		
(h)	Size of cable		
(i)	Cable entry		
ii	Constructional Requirement		
(a)	Thickness of sheet steel		
	i) Frame, Frame enclosures, doors covers and partition	Mm	
(b)	Degree of protection		
(c)	Colour finish shade		
(d)	Earthing bus	Material	
		Size	
(e)	Earthing conductor	Material	
		Size	
iii	Design Requirement		
(a)	Insulation level	kV (rms)	
(b)	Capacitor bank connection		
(c)	Short circuit withstand for busbars		
	i) Short time (1 sec)	kA (rms)	
	ii) Dynamic	kA (peak)	
(d)	Type of switching & capacitor		
(e)	Switching steps		
(f)	Rating of contactor		
(g)	Incomer switch current rating		
(h)	Busbars		

#### 4) HV, LV POWER & CONTROL CABLES

S.N.	Description	Unit	Technical Particulars	Technical Particulars	Technical Particulars
			0.415kV power cables	33kV power cables	Control cables
1	Name of the Manufacturer				
2	Conductor(stranded/solid)				
2.1	Form circular/segmented				
2.2	Nominal diameter in mm				
2.3	Effective cross sectional area sq mm				
3	Whether cores identified by numeral for cable with five core and above.				
4	Whether incremental running lengths are marked on cable at every 1 m interval.	YES/NO			
5	Finished cable				
5.1	Diameter under armour in mm				
5.2	Diameter over armour in mm				
5.3	Overall diameter in mm				
6	Whether cables will carry ISI stamp.	YES/NO			
6.1	If not explain reasons				
7	Cable drums				
7.1	Length of cables in cable drum and tolerance				
7.2	Weight of cable drum without cables				
7.3	Weight of cable drum with cables				
8	Type of end sealing				
9					
9.1	Any other details the CONTRACTOR would like				

S.N.	Description	Unit	Technical Particulars	Technical Particulars	Technical Particulars
			0.415kV power cables	33kV power cables	Control cables
	to furnish?				
9.2	List of deviations if any from specification, data sheet-A and applicable standard furnished				
9.3	Conductor screen				
9.4	Insulation				
9.5	Insulation screen				
9.6	Sheath				
9.7	Armour				

**5) LIGHTING FIXTURES & ACCESSORIES**

Sr. No.	Parameter	Technical Particulars (To be filled by BIDDER)
1.	Type	
2.	Rated Voltage	
3.	Expected Frequency	
4.	Operating Voltage Range	
5.	Power Factor	
6.	Operating Temperature Range	
7.	Working Humidity	
8.	Driver Type	
9.	Driver Efficiency	
10.	Driver Life	
11.	Protection required in Driver module	
a.	Short Circuit	
b.	Over Voltage	
c.	Over Temperature	

<b>Sr. No.</b>	<b>Parameter</b>	<b>Technical Particulars (To be filled by BIDDER)</b>
d.	Under Voltage	
e.	String Open Protection	
12.	Luminaire IP Protection	
13.	Minimum Surge Protection	
14.	THD	
15.	Rated Minimum LED Life (L70)	
16.	Rated Minimum Driver Life	
17.	CRI	
18.	Junction temperature rise	
19.	Solder point temperature	
20.	Maximum temperature rise for Driver	
21.	Make of LED	
22.	Make of Driver	
23.	Operating Hours	
24.	Luminous Efficacy	
25.	System Efficacy	
26.	Colour Temperature	
27.	Illumination Regulation	
28.	Material used for following	
a.	Housing	
b.	Heat Sink	
c.	Clip / Fasteners	
d.	Diffuser	
29.	Maximum temperature of Heat sink	
30.	IK protection of Optic Cover	
31.	Wires used Inside Luminaries	
32.	Cable gland IP protection	
33.	Ratio of Horizontal to Vertical Illuminance	
34.	Glare index while viewing from critical observer position	
35.	Maintenance factor	

Sr. No.	Parameter	Technical Particulars (To be filled by BIDDER)
36.	Total of LED fixture	
37.	Wattage of each fixture	
38.	Total Power Consumption	

**6) LIGHTING SYSTEM EQUIPMENT**

S.N.	Description	Unit	Technical Particulars
1	<b>LIGHTING DISTRIBUTION BOARDS AND LIGHTING PANELS</b>		
1.1	System Particular		
(a)	Voltage		
(i)	3 Phase, 4 wire 50 Hz system		
	Rated	V	
	Maximum	V	
	One minute withstand voltage	V	
(ii)	D.C. system		
	Rated	V	
(b)	System short-circuit level		
	(i) At 415 V, A.C.	kA (rms)	
	(ii) At 110 V.D.C.	kA (D.C.)	
(c)	Reference ambient temperature	deg C	
1.2	Indicate the type and routine tests to be carried out		
1.3	Distribution Board/Panels		
(a)	Main, floor mounted distribution boards		
(i)	Main Lighting distribution board(A.C.)		
	Make		
	Type		
	Degree of protection		
	Bus bar material		
	Bus bar current rating	A	
	Short circuit current rating	kA	



S.N.	Description	Unit	Technical Particulars
	Details of Incoming and Outgoing feeders		
	Cable entry		
	Location		
	Each complete board/panel, LxWxD		
	Dimensional drawing enclosed		
	Indicate the type and routine tests to be carried out		
(ii)	Emergency lighting panel (D.C.)		
	Make		
	Type		
	Degree of protection		
	Bus bar material		
	Bus bar current rating	A	
	Short circuit current rating	kA	
	Details of Incoming and		
	Outgoing feeders		
	Cable entry		
	Location		
	Each complete board/panel, LxWxD		
	Dimensional drawing enclosed		
	Indicate the type and routine tests to be carried out		
(iii)	Three phase DBs, wall/structure mounting		
	SLDB for indoor area		
	Make		
	Type		
	Details of Incoming and Outgoing feeders		
	Degree of Protection		
(iv)	SLDB for outdoor area		
	Make		
	Type		
	Details of Incoming and Outgoing feeders		
	Degree of Protection		
(v)	Paint Finish		
	Colour shade		

S.N.	Description	Unit	Technical Particulars
2	<b>MINIATURE CIRCUIT BREAKER</b>		
2.1	Make		
2.2	Type		
3	<b>EARTH LEAKAGE CIRCUIT BREAKER</b>		
3.1	Make		
3.2	Type		
3.3	Leakage Current $I_N$	mA	
4	<b>INSTRUMENT TRANSFORMERS</b>		
4.1	Make		
4.2	Type		
4.3	Output		
4.4	Accuracy Class		
5	<b>METERS</b>		
5.1	Make		
5.2	Type		
5.3	Accuracy Class		
6	<b>RELAYS (IF ANY PROVIDED)</b>		
6.1	Make		
6.2	Type		
6.3	Voltage Rating	V	
6.5	Setting Range	%	
	No. of Contacts		
	a)Normally open		
	b)Normally closed		
7	<b>FLAME PROOF ENCLOSURES</b>		
7.1	Make		
7.2	Suitable for use in hazardous area		
	a)Area classification		
	b)Gases/Vapour group		
7.3	Dimensional Drawings and Literature of each required equipment flameproof enclosure including fixing details enclosed	Yes/No	
7.4	Approval certificates of relevant statutory authorities enclosed	Yes/No	
8	<b>LIGHT CONTROL SWITCHES</b>		

S.N.	Description	Unit	Technical Particulars
8.1	Make		
9	<b>RECEPTACLE, PLUG AND SWITCH</b>		
9.1	Make		
10	<b>LIGHTING WIRES</b>		
10.1	Make		
10.2	Applicable Standard		
10.3	Voltage Grade	V	
10.4	Conductor Material	Cu/Al	
10.5	No.of Strands	mm <sup>2</sup>	
10.6	Colour Coding		
11	<b>CONDUITS</b>		
11.1	Make		
11.2	Material		
11.3	Finish (Galvanised/Black Enamel/Any special anti-corrosive coating)		
11.4	Sizes offered and wall thicknesses		
11.5	Supply of necessary couplings, bends, tees, necessary for conduit routing included	Yes/No	
12	<b>JUNCTION BOXES</b>		
12.1	Make		
12.2	Material and Gauge		
12.3	Painted / Galvanised		
13	<b>CEILING FANS</b>		
13.1	Make		
13.2	Suspension Rod, Regulator and Switch included	Yes/No	

#### 7) EARTHING & LIGHTNING PROTECTION SYSTEM

S. No.	Description	Material	Technical Particulars
1	<b>Main Earthing Grid</b>		
a)	Buried in earth	MS	
b)	Buried in floor slabs in buildings	MS	

S. No.	Description	Material	Technical Particulars
2	<b>Conductor Leads To Equipment (above ground) – Substation Equipment &amp; Structures</b>		Quantity - As per requirement & Sizes – As per Fault level calculations
a)	Circuit Breaker	GS	
b)	Isolator	GS	
c)	Transformers		
	(i) Transformer neutral to bottom of tank	GS	
	(ii) From bottom of tank to earth grid	GS	
	(iii) Transformer tanks and radiator bank	GS	
	(iv) Marshalling Boxes	GS	
d)	Lightning arrester	GS	
e)	C.T. and P.T. body	GS	
f)	C.T. and P. T. secondary terminal box	GS	
g)	Towers and structures	GS	
h)	Fence posts and gates (Flex. braid)	GS	
i)	415V switchgear and capacitor panel	GS	
j)	Motors		
	(i) 415V Motors above 10 kW	GS	
	(ii) 415V Motors up to 10 kW	GI wire	
	(iii) Fractional horse power motors	GI wire	
k)	Other Items		
	Capacitor panel, Battery charger panel, Main lighting D.B, Control panels and sub-lighting distribution boards	GS	
	Hand Rails	GS	
	Cable trays	GS	
	Tanks	GS	
	Junction boxes	GS	
	Lighting fixtures, receptacles, lighting conduits	GS	
	Push button stations, limit switches	GS	
	Crane rail	GS	
	Street lighting, flood lighting poles and junctions boxes	GS	
	Metallic non-current carrying structures	GS	

S. No.	Description	Material	Technical Particulars
	Lightning Conductors	GS	
	Lightning protection down comers for building	GS	
	Lightning protection horizontal roof conductor for building	GS	
	Electrodes	GS	
	Pipe electrode	GS	
	Maintenance free electrode	copper	

8) **DG SET**

Sr. No.	Description	Unit	Technical Particulars
1.0	GENERAL		
1.1	Name of manufacturer		
1.2	Engine model no.		
2.0	DESIGN FEATURES		
2.1	Continuous site output rating at generator terminals	<b>kW</b>	
2.2	Site output rating after auxiliary power consumption and transmission losses at switchyard/ bus bar terminals	<b>kW</b>	
2.3	Maximum site rating of engine (to be not less than 110% of the value indicated in item 2.1 above)	<b>kW</b>	
2.4	Standard engine rating (i.e., under standard atmospheric conditions as per ISO : 3046)	<b>kW</b>	
2.5	Derating factors for site conditions applicable on standard engine rating :	%	
	a) Altitude	%	
	b) Ambient temperature	%	

Sr. No.	Description	Unit	Technical Particulars
	c) Relative humidity at inlet temperature indicated in item (b) above	%	
	d) Cooling water temperature at the inlet of charge air cooler	%	
	e) Others	%	
	f) Total deration	%	
	N.B.  If the derating factors are different from those indicated in ISO : 3046 the BIDDER shall furnish details in deviations there from, justifying the deratings as applicable for the offered engine. Derating charts / calculations shall be furnished along with the Bid for various atmospheric conditions		
2.6	Operating speed	RPM	
2.7	Main effective pressure (referred to kW output)	Pa(g)	
2.8	Types of operating cycle		
2.9	Mean piston speed	m/sec	
2.10	Design fuel oil		
2.11	Design lube oil		
3.0	ENGINE PERFORMANCE		
3.1	Continuous engine rating at site at generator (with specified fuel oil) with all coupled to engine	<b>kW</b>	
3.2	10% overload operation as per ISO 3046		<b>Yes/No</b>
3.3	Fuel consumption (with design fuel)		

Sr. No.	Description	Unit	Technical Particulars
	a) At 100% engine load	g / KW h	
	b) At 75% engine load	g / KW h	
	c) At 50% engine load	g / KW h	
3.4	Lube oil consumption at 100% engine load	g / KW h	
3.5	Primary jacket water temperature at engine inlet	°C	
3.6	Primary jacket water temperature engine outlet	°C	
3.7	Secondary cooling water temperature at heat exchangers inlet	°C	
3.8	Secondary cooling water temperature at inlet to cooling tower,	°C	
3.9	Secondary cooling water flow	m <sup>3</sup> /hr.	
3.10	Maximum Secondary Water pressure drop through heat exchanger at flow value indicated in 3.9 above	Pa	
3.11	Secondary cooling water pressure at heat exchanger inlet	Pa	
3.12	Lube oil temperature at lube oil cooler outlet	°C	
3.13	Lube oil temperature at lube oil cooler inlet	°C	
3.14	Maximum period for which engine can operate without cooling water c		
	a) During cold start of engine	Secs.	
	b) During hot start of engine	Secs.	
3.15	Flue gas analysis at 100% load for		

Sr. No.	Description	Unit	Technical Particulars
	specified fuel :		
	a) SO <sub>2</sub>		
	b) Nox		
	c) Hydro carbon		
	d) CO <sub>2</sub>		
	e) CO		
	f) Particulate matter		
	g) Others		
	h) SO <sub>2</sub> through stack	Kg/hr	
3.16	Governing Characteristics		
3.16.1	Maximum step load that can be applied to the engine at full rated speed, no load and at normal running temperatures	% of rated load	
3.16.2	Transient speed change resulting from applications of the load indicated in item 3.16.1 above	% of rated load	
3.16.3	Permanent speed change resulting from application of the load indicated in item 3.16.1 above	% of rated load	
3.16.4	Maximum recovery time to permanent speed change of 3.16.3	Secs.	
3.16.5	Transient speed rise resulting from a full load throw-off	% of rated load	
3.16.6	Permanent speed rise resulting from a full load throw-off	% of rated load	
3.16.7	Maximum recovery time to reach permanent speed rise value indicated in item 3.16.6 above	Secs.	



Sr. No.	Description	Unit	Technical Particulars
3.16.8	Transient speed change resulting from a change of load, both ON and OFF, by any step of 25% of the rated full load	% of rated load	
3.16.9	Permanent speed change resulting from change of load, both ON and OFF, by any step of 25% of the rated full load	% of rated load	
3.16.10	Recovery time for attaining permanent speed change value indicated in item 3.16.9	Secs.	
3.16.11	Steady load speed band	% of rated load	
3.17	DG set starting time i.e., ready to take load after "start" impulse	Secs.	
3.18	Maximum noise level at .....metres from equipment outline	dBA	
3.19	Maximum vibration level (peak to peak)	mm/sec.	
4.0	GENERATOR PERFORMANCE		
4.1	Generator efficiency at 100% rated load	%	
4.2	Generator efficiency at 75% rated load	%	
4.3	Generator efficiency at 50% rated load	%	
4.4	Generator efficiency at 25% rated load	%	
4.5	Voltage regulator response	%	
4.6	Excitation at full load and under specified variation of voltage and speed		
5.0	ENGINE CONSTRUCTION FEATURES		

<b>Sr. No.</b>	<b>Description</b>	<b>Unit</b>	<b>Technical Particulars</b>
5.1	Engine model No.		
5.2	No. of strokes		Two / Four Strokes
5.3	No. of cylinders		
5.4	Arrangement of cylinders		Inline / Vee Type
5.5	Cylinder bore	mm	
5.6	Piston stroke	mm	
5.7	Compression ratio		
5.8	Cylinder block :		
	a) Material of construction		
5.9	Crank case :		
	a) Material of construction		
5.10	Cylinder head :		
	a) Material of construction		
5.11	Cylinder liner :		
	a) Material of construction		
5.12	Crank shaft :		
	a) Forged / cast		
	b) Material of construction		
5.13	Crank shaft main bearings:		
	a) Nos. provided		
	b) Material of construction		
5.14	Piston :		
	a) Type		
	b) Material of construction		

Sr. No.	Description	Unit	Technical Particulars
5.15	Piston rings:		
	a) Material of compression rings		
	b) Material of oil rings		
5.16	Piston pin (Gudgeon pin):		
	a) Material of construction		
5.17	Connecting rod :		
	a) Material of bearings		
	b) Lining for bearing materials		
5.18	Camshaft:		
	a) Material of bearings and lining details		
	b) Mode of driving from crankshaft		
5.19	Engine valves :		Inlet                      Exhaust Starting                      Valve Valve                      Valve Air Valve
	a) Nos. provided per cylinder		
	b) Material of valve body		
	c) Material of valve seat		
	d) Type of valve cooling		
5.20	Oil pan:		
	a) Capacity upto normal working level	m <sup>3</sup>	
	b) Material of construction		
5.21	Gaskets – Material of construction :		
	a) Between cylinder head and cylinder block		

Sr. No.	Description	Unit	Technical Particulars
	b) Between cylinder block and oil pan		
	c) Between cylinder block and end corners		
5.22	Fly wheel with cover		Provided / Not provided
5.23	Fuel injection System :		
	a) Type of system		
	b) Engine driven fuel feed pump provided		Yes / No
5.24	Governing system type		
5.25	Foundation details :		
	a) No. of holding down bolts		
	b) Anti-vibration springs with visco dampers		Yes/ No
6.0	ENGINE SYSTEMS		
6.1	Fuel Oil system :		
a	Fuel Oil tanks ( For each tank )		
	a) Nos. provided		
	b) Working capacity of each tank	m <sup>3</sup>	
	c) Size of tank :		
	i) Rectangular tank	mxmxm	
	ii) Cylinder tank	Dia(m)xHt(m)	
	d) Material of construction		
	e) Location		
b	Motor operated transfer pumps furnished		Yes / No
	( For each pump )		

Sr. No.	Description	Unit	Technical Particulars
	a) Nos.		
	b) Type		
	c) Capacity	m <sup>3</sup> /hr.	
	d) Motor Rating	KW	
c	Fuel oil filters		2 x 100 % Simplex / 1 x 100 % Duplex
d	Maximum pressure drop across filters in clogged condition		
e	Through put capacity of fuel oil treatment plant at specified viscosity of fuel oil		
f	No. of fuel oil treatment units provided.		
g	Separating temperature		
6.2	Lube oil System :		
a	Type and grade of lube oil to be used		
b	Capacity of lube oil sump below cylinder block / crane case at normal working level	m <sup>3</sup>	
c	Lube oil tanks external to engine ( For each tank )		Yes / No
d	a) Capacity	m <sup>3</sup>	
e	b) Material of construction		
f	c) Location		
g	Engine driven / Motor Driven lube oil pump :		
	a) Nos.		
	b) Type		
	c) Capacity	m <sup>3</sup> /hr.	

Sr. No.	Description	Unit	Technical Particulars
	d) Motor Rating	KW	
h	Lube oil cooler :		
	a) Type		
	b) Cooling fluid		
	c) Secondary Cooling Water flow / Primary Jacket Water flow	m <sup>3</sup> /hr.	
i	Lube oil filters :		
	a) Type		2 x 100 % Simplex / 1 x 100 % Duplex
	b) Maximum allowable pressure drop across filter in clogged condition		
j	Lube oil heater :		
	a) Provided		Yes/ No
	b) Type		
	c) If electric, indicate power rating	kW	
k	AC motor driven priming pump :		
	a) Nos. provided		
	b) Type		
	c) Capacity	m <sup>3</sup> /hr.	
	d) Head	m	
	e) Motor rating	kW	
l	Quantity of lube oil required for initial filling	m <sup>3</sup>	
m	Through put capacity of lube oil treatment plant at specified viscosity of		

Sr. No.	Description	Unit	Technical Particulars
	fuel oil		
n	No. of lube oil treatment units provided.		
o	Separating temperature		
6.3	Primary Jacket Water System		
a	Type of cooling		Radiator cooled / Secondary cooling water cooled
b	Quality of water		
c	Quantity of water required for initial filling	m <sup>3</sup>	
d	Makeup water quantity	m <sup>3</sup> /hr.	
e	Expansion tank :		
	a) Working capacity	m <sup>3</sup>	
	b) Size :		
	i) Rectangular	m <sup>3</sup>	
	ii) Cylindrical	Dia(m)xHt(m)	
	c) Material of construction		
	d) Inner coating details		
f	Jacket Water Pump and jacket water pre heating pump		
	a) Type		Engine driven / AC motor driven
	b) Capacity	m <sup>3</sup> /hr.	
	c) Head	mlc	
	d) Mode of driving off engine crank shaft		

Sr. No.	Description	Unit	Technical Particulars
	e) Motor Rating	KW	
g	Radiator (if required)		
	a) Type		
	b) Overall size		
	c) Materials of construction :		
	i) Tubes		
	ii) Fins		
	iii) Header		
	d) Location		
	e) Radiator fan :		
	i) Tip diameter	mm	
	ii) Max. speed	rpm	
	iii) Flow at above speed	m <sup>3</sup> /hr.	
	f) Air temperature rise across radiator		
	g) Mode of drive from engine crank shaft		
	h) Material of construction of fan :		
	i) Blades		
	ii) Hub		
	i) Air ducting details :		
	i) Material of construction		
	ii) Inside clear dimensions	mmxmm	
	iii) Type of fixing arrangement between air duct and radiator		
	j) Fan guard provided		Yes / No



Sr. No.	Description	Unit	Technical Particulars
	k) Fan motor rating	KW	
h	Heat Exchanger :		
	a) Designation		
	b) Type		Shell & tube type / plate type
i	Jacket water heater :		
	a) Nos. provided		
	b) Type		
	c) If electric, power required	kW	
6.4	Air intake system :		
a	Intake silencer type		
b	Air cleaner :		
	a) Type		Wet/ Dry
	b) Nos. provided		
	c) Design air flow	m <sup>3</sup> /hr.	
	d) Materials of construction:		
	i) Body and cover		
	ii) Filter element		
	e) Type of oil to be used for wet type		
	f) Frequency of oil cleaning filter element cleaning		
	g) Location		
c	Turbocharger (exhaust gas driven) :		
	a) Speed	Rpm	
	b) Air pressure at outlet	Pa(g)	

Sr. No.	Description	Unit	Technical Particulars
	c) Air temperature at outlet	°C	
	d) Maximum air flow	Nm <sup>3</sup> /hr.	
	e) Blade material		
	f) Casing material		
d	Supercharger (engine driven) :		
	a) Type		Roots type
	b) No. of lobes		Two / Three
	c) Speed	rpm	
	d) Air flow	Nm <sup>3</sup> /hr.	
	e) Air outlet pressure	Pa(g)	
	f) Air outlet temperature	°C	
	g) Material of construction :		
	i) Lobes		
	ii) Casing		
	iii) Shafts		
	iv) Bearings		
	v) Seals		
	vi) Timing gears		
	b) Type of drive from engine crank shaft		
e	Charge air cooler :		
	a) Type		
	b) Nos. provided		
	c) Cooling water type		
	d) Design water flow required	m <sup>3</sup> /hr.	

Sr. No.	Description	Unit	Technical Particulars
	e) Pressure drop at above flow	mlc	
	f) Inlet water temperature	°C	
	g) Temperature rise	°C	
	h) Charge air temperature at cooler outlet	°C	
	i) Material of construction :		
	i) Tubes		
	ii) Fins		
	iii) Cover		
	iv) End plates		
6.5	Exhaust gas system:		
6.5.1	No. of streams provided		
6.5.2	Exhaust silencer		
	a) Nos. provided per exhaust pipe		
	b) Type		
	c) Location		
6.5.3	Exhaust Duct		
	a) Size		
	b) Material		
6.5.4	Lagging details :		
	a) Lagging material		
	b) Lagging thickness		
6.6	Air starting system :		
6.6.1	Nos of compressors motor driven		
6.6.2	Nos of compressors diesel engine		

Sr. No.	Description	Unit	Technical Particulars
	driven		
6.6.3	Compressor details		
	a) Manufacturer		
	b) Type		
	c) Rating		
	d) Speed	rpm	
6.6.4	Air receivers / air bottles		
	a) Nos. provided		
	b) Air capacity of each air receiver	m <sup>3</sup>	
	c) Normal air pressure in air receiver	Pa(g)	
	d) No. of starts of engine from each receiver		
6.6.5	Normal air pressure for starting	Pa(g)	
6.6.6	Minimum air pressure for starting engine	Pa(g)	
6.6.7	Quantity of free air per start	Nm <sup>3</sup> /hr.	
6.7	Common base frame for engine and generator:		
	Type		
	Material of construction		
6.8	Engine generator coupling :		
a	Type		
b	Whether fixed directly to fly wheel :		Yes / No
c	Clutch with engaging / disengaging arrangement provided?		Yes / No

Sr. No.	Description	Unit	Technical Particulars
d	Coupling guard material		
e	Coupling guard for clutch provided ? If 'Yes' indicate type		Yes / No
7.0	GENERATOR AND ACCESSORIES		
7.1	Name of manufacturer		
7.2	Design rating	kW	
7.3	Continuous output rating	kW	
7.4	Maximum rating	kW	
7.5	Power factor		
7.6	Rated voltage	Volts	
7.7	Rated current/ phase	Amps	
7.8	Speed	rpm	
7.9	Frequency	C/s	
7.10	Field current at rated output and voltage	Amps	
7.11	Insulation class :		
	a) Stator		
	b) Rotor		
7.12	Temperature rise above ambient of 45°C (by thermometer):		
	a) Stator	°C	
	b) Rotor	°C	
	c) Cores	°C	
7.13	WR <sup>2</sup> of rotating mass in diesel engine, generator, exciter, etc.	kgm <sup>2</sup>	
7.14	Generator parameters :		

Sr. No.	Description	Unit	Technical Particulars
7.14.1	Synchronous reactance $X_d$ :		
	a) Unsaturated	Ohms	
	b) Saturated	Ohms	
7.14.2	Transient reactance $X'_d$ :		
	a) Unsaturated	Ohms	
	b) Saturated	Ohms	
7.14.3	Sub-transient reactance $X''_d$ :		
	a) Unsaturated	Ohms	
	b) Saturated	Ohms	
7.14.4	Zero sequence reactance $X_0$	Ohms	
7.14.5	Negative sequence reactance $X_2$	Ohms	
7.14.6	Open circuit transient time constant	secs.	
7.14.7	Open circuit synchronous time constant	secs.	
7.14.8	Open circuit field time constant T	secs.	
7.14.9	Short circuit ratio		
7.14.10	Resistance of field winding at operating temperature	Ohms	
7.14.11	Resistance of stator winding at operating temperature	Ohms	
7.15	Generator performance :		
7.15.1	Full load losses	kW	
7.15.2	Armature copper loss	kW	
7.15.3	Rotor copper loss	kW	
7.15.4	Core loss	kW	
7.15.4	Stray losses	kW	

Sr. No.	Description	Unit	Technical Particulars
7.15.5	Efficiency :		
	a) ¼ load	%	
	b) ½ load	%	
	c) ¾ load	%	
	d) Full load	%	
8.0	MAIN EXCITER		
8.1	Rated voltage	Volts	
8.2	Rated current	Amps	
8.3	Ceiling voltage at zero load and rated speed	Volts	
8.4	Ceiling voltage at rated current and rated speed	Volts	
8.5	Excitation system response ratio		
8.6	Insulation class:		
	a) Stator		
	b) Rotor		
9.0	AUTOMATIC VOLTAGE REGULATOR		
9.1	Type		
9.2	Burden of AVR on CTs and PTs		
	a) CTs	Va	
	b) PTs	Va	
9.3	Dead band (if any)		
9.4	Field discharge resistor	Ohms	
9.5	Type and rating of field breaker		
10	TESTING		

Sr. No.	Description	Unit	Technical Particulars
10.1	BIDDER to indicate whether the following tests will be conducted :		
10.2	Dimensional accuracy of individual components		Yes / No
10.3	Hydro testing of all jacket water passages		Yes / No
10.4	Hydro testing of all lube oil lines		Yes / No
10.5	Hydro testing of fuel oil lines		Yes / No
10.6	Checking all lube oil passage for free flow of oil		Yes / No
10.7	Rig testing of governor assembly		Yes / No
10.8	Rig testing of individual injectors		Yes / No
10.9	Shop testing of engine with all the engine driven equipment in position		Yes / No
11	WEIGHTS		
11.1	Weight of fully assembled engine	kg	
11.2	Weight of generator	kg	
11.3	Weight of common base frame	kg	
11.4	Weight of fully assembled engine generator	kg	
11.4	GD2 for DG set	Kg/m <sup>2</sup>	
11.5	Weight and name of heaviest part to be lifted during : a) Erection b) Maintenance	kg	
12	DIMENSIONS		
12.1	Overall dimension of engine		
12.2	Overall dimension of generator		



Sr. No.	Description	Unit	Technical Particulars
12.3	Height and name of longest part to be lifted during maintenance		

**9. TECHNIAL DATASHEET FOR LIFT**

Sl. No.	Description	Specification Requirement		Bidder's Data		
General	1. Lift Category	a) Passenger Lift	(As per Arch Layout)			
		b) Service Lift	(As per Arch Layout)			
		c) Goods Lift	(As per Arch Layout)			
	2. Quantity	Nos.	(As per design)			
	3. Installation		Indoor			
	4. Hazardous area classification (IS 5572)	*	NA			
	5. Corrosive Location	*	NA			
	6. Seismic Acceleration Factor	*	As per IS			
	7. Power Supply	415V, 3 ph, 3 wire supply	Yes			
	8. Overhead height available	*	(As per Arch Layout)			
9. Pit depth available	*	(As per Arch Layout)				
Particulars	1. Make	*	<b>(Kone/ Otis/ Thyssen</b>	Particulars		

Sl. No.	Description	Specification Requirement		Bidder's Data	
			<b>Krupp / Mitsubishi / Johnson/S chindler)</b>		
	2. Rated Load				
		a) Single Point Load (kg)	As per design		
		b) Uniformly distributed Load (kg)			
	3. Capacity (in kg.)		Persons load as per BOQ + 250 Kgs as provision for flooring considering marble \ granite flooring. *		
	4. Capacity ( No of Person)		(As per Arch Layout) *		
	5. Rated Speed m/sec		As per NBC *		
	6. Total Rise m		(As per Arch Drawings) *		
	7. No of floors served		(As per Arch Drawings) *		
	8. Lift Well Drawing number		Bidder to provide *		
	9. Lift Well Dimensions mm x mm		Bidder to provide *		

Sl. No.	Description	Specification Requirement		Bidder's Data		
	10. Lift Car Dimensions mm x mm	*	Suit to site condition and minimum requirement as per NBC, 2300 mm clear height under false ceiling.			
	11. Levelling Zone	*	As per IS14665			
	12. No. of doors in the car	*	SINGLE SIDE			
3 Lift Control Operation	1. Control Type		P.M.S.M. AC VVVF motor	3 Lift Control Operation		
	2. Operation	a) automatic with Attendant ( with or without key)	automatic with Attendant ( with or without key) only for commercial building			
		b) automatic without Attendant	automatic without Attendant for Group housing			
	3. Automatic Operation Type	A) Non Selective Collective				
		B) Selective Collective				
		C) Single Automatic				

Sl. No.	Description	Specification Requirement		Bidder's Data		
		D) Group Automatic	Group Automatic			
		E) Car Switch Operation				
		F) Signal Operation				
		G) Single/Double Button Operation				
	4. Levelling Device	A) Lift Car				
		B) One Way Automatic				
4 Operating devices	1. In The Car(Yes/No)	A) Up Push Button	Yes	Braille buttons of micro pressure type corresponding to the floors served. The push buttons to be of robust SS Vandal Resistant type.		
		B) Down Push Button	Yes	Car & landing indicator shall be blue white segment LCD		
		C) Number Pushbuttons for each landing	Yes	Braille Marking Buttons on Car operating panel and landing push buttons		
		D) Non Stop Push button	Yes	The height of the Floor buttons to be such so as to be accessible by person sitting on wheel chair conforming to IS15330:2003		
		E) Door Open Push button	Yes			
		F) Door Close Push button	Yes			
		G) Alarm Push button	Yes			

Sl. No.	Description	Specification Requirement		Bidder's Data		
		H) Emergency Stop Push-Button	Yes			
		I) Key Operated Selector for Attendant Operation	Yes			
	2. In The Landing (Yes/No)	A) Up Push Button	Yes			
		B) Down Push Button	Yes			
		C) Lift Push Button	No			
		D) Bell Push Button	No			
	3. In the machine room (yes/no)	A) Up Push Button	Yes			
		B) Down Push Button	Yes			
		C) Hand Cranking Device	Yes			
		D) Stop Push Button	Yes			
		E) Slow Speed Operation Selector	Yes			
	4. On The Top Of The Car (Yes/No)	a) Up Push Button	Yes			
		b) Down Push Button	Yes			
		c) Stop Push Button	Yes			
		d) 240 V	Yes			

Sl. No.	Description	Specification Requirement		Bidder's Data		
		1phase Receptacle				
5	1. In The Car (Yes/No)	a) Up Direction Of Travel	Yes			
		b) Down Direction Of Travel.	Yes			
		c) Floor Position Indicator (Illuminated Numeral For Each Landing)	Yes			
		d) Landing Call Registering Unit (With Buzzer & Registration Cancelling Unit & Lamp Test Push Button)	Yes			
		e) Building Name Display :	Yes			
		f) Capacity Indicator	Yes			
		g) Overload Warning Indicator	Yes			
		h) Digital Temperature Indicator	Yes			
	2. In the Landing (Yes/NO)	a) Up Direction Of Travel	Yes			
		b) Down Direction Of Travel	Yes			
		c) Location Of Direction	Yes			

5 Indicating Devices

Sl. No.	Description	Specification Requirement	Bidder's Data			
		Indicator				
		d) Car Position Indicator (Illuminated Num-Erals For Each Landing)	Yes			
		e) Location Of The Position Indicator	Yes			
		f) Call Registered Indicator	Yes			
		g) Lift Engaged Indicator	Yes			
		h) Call Registered Up Indicator	Yes			
		i) Call Registered Down Indicator	Yes			
6 Car and Landing doors	1.Type Of Doors	a) Centre Opening Sliding	Centre Opening Sliding			
		b) Mid Bar Collapsible				
		c) Single Slide				
		d) Swing				
		e) Vertical Biparting				
		f) Two Speed Sliding				

Sl. No.	Description	Specification Requirement	Bidder's Data			
		g) Vertical Lifting				
	2. Door Operator					
	3. Vision Panels in Doors					
	4. Colour Shade for Outside Landing Doors	(*) refer below for finishes				
	5. Colour Shade for Car Door	(*) refer below for finishes				
	6. Material of the Door	Stainless steel				
	7. Car inside panels finish	(*) refer below for finishes				
	8. Car & landing door panels finish	Hairline Stainless steel				
	9. Flooring material	25 mm recess for marble \ granite				
	10. False ceiling	(*) refer below for finishes				
	11. Entrance door minimum dimensions	1100 (W) x 2200(H)				
	12. Infra Red Door Protection Device	3D Infra red door detector covering full height & width of entrance with LEDs on edges & with variable timing.				
	13. Car safety	Flexible guide rails clamp type				
	14. Over speed protection	Over speed governor at top of car				
	15. Door fire protection	2 hours				



Sl. No.	Description	Specification Requirement	Bidder's Data		
	in hours				
	16. Safety buffers type	Oil buffers			
	17. Hand rails	35mm dia, Stainless steel on three side-min 16 gauge grade 304			
	18. Landing door lock type	Yes			
	19. Landing door lock safety	Yes			
7 Miscellaneous details	1. Car Lighting	Lighting-LED for 100 lux, Provide fully automatic operation of the lighting inside the car to put off the lights when idle.			
	2. Car Ventilation Fan With Switch (Yes / No)	Provide fully automatic operation of the ventilator fan inside the car interlocked with the car movement.			
	3. Décor Inside The Car				
	4. Hoist Machine	AC Gearless Traction			
	5. Leveling accuracy	± 3 mm at all load conditions			
	6. Speed variation	+/- 1% of the rated speed			

Sl. No.	Description	Specification Requirement		Bidder's Data		
	7. Enclosure For Elect. Equip. Located Outside The M/C Room	a) Dust Tight	Yes			
		b) Water Tight	Yes			
		c) Corrosion Proof	Yes			
	8. Emergency Exit (Yes / No)		Yes			
	9. Provision For Opening The Landing Door In Case Of Emergency		Yes			
		a) Channelled Music Speaker	Yes			
		b) Camera	Provide / provision for CCTV for all cars with necessary arrangement in travelling cables for IP based system			
		c) Audible Floor Position Announcement	Yes			
		d) Mirror	No			
		e) Hand Rail	Three sides			
		f) Operating Device & Indication	Yes			
		g) Panel On Two Sides	One side			

Sl. No.	Description	Specification Requirement	Bidder's Data	
		h) Flooring Details	granite /marble	
		i) Facility For Receiving Fire Alarm Signal	Provide potential free contact to accept the fire alarm signal from fire alarm panel provided by FAS contractor to automatically ground the elevator on receipt of this signal.	
		j) Provision Of Rs 232 / Rs 485 For Connecting To Building Automation System.	Provide potential free contacts and necessary software compatibility	
	2. Inching Control		Yes	
	3. Stop blocked in floors		Yes	
	4. Fire Extinguisher		Yes	
	5. Material of the Lift Rope : Steel/ Stainless Steel		Stainless Steel	
	6. Automatic rescue device included Yes/No		Yes	
	7. Machine Room location		Machine Room Less	

**10. EV CHARGER DATA SHEET-**

AC INPUT	
LINE VOLTAGE	
VOLTAGE TYPE	

FREQUENCY	
POWER FACTOR	
CURRENT THD VALUE	
OUTPUT	DC OUTPUT
NOMINAL OUTPUT VOLTAGE	
OUTPUT CURRENT	
REGULATION ACCURACY	
STEADY CURRENT ACCURACY	
RIPPLE POWER FACTOR	
OUTPUT POWER	
EFFICIENCY	
MECHANICAL INDICATORS	
APPROXIMATE DIMENSION (W*H*D)MM	
SYSTEM WEIGHT	
PROTECTION GRADE	
OPERATING TEMPRETURE	
STORAGE TEMPRETURE	
HUMIDITY	
PROTECTION FUNCTION	
BMS COMMUNICATION	
COOLING	
DISPLAY	
USER RECOGNITION	
DC PLUG -1	
COMPLIANCE STANDARD	

**11. UPS-**

	DESCRIPTION	TECHNICAL PARTICULARS
1.1	Application	
1.2	Power rating at load PF 0.8 lagging	.....KVA continuous
1.3	Quantity (nos.)	
1.4	Method of energy storage	
1.5	Type	
1.6	Installation	
1.7	Ambient Temperature (0C)	
2	ENCLOSURE	
2.1	Sheet steel thickness	
2.2	Degree of protection as per IS-13947	
2.3	Painting	
	- Exterior	
	- Interior	
2.4	Cable Entry	
2.5	Acoustic Noise level	
2.6	Space heater, 240V, 1 Ph	
3	UPS SYSTEM	
3.1	Input	
3.1.1	Supply voltage	
3.1.2	Allowable Variation	

	(a)	Voltage	
	(b)	Frequency	
	(c)	Combined voltage + frequency	
3.2	Output		
3.2.1	Output voltage		
3.2.2	AC voltage accuracy (steady state) over entire load, load PF & DC voltage range.		
3.2.3	Transient voltage regulation		
3.2.4	Transient recovery		
3.2.5	Voltage wave form		
3.2.6	Range of adjustment of AC output voltage		
3.2.7	AC Harmonic content(THD-Voltage)		
3.2.8	Phase displacement for three phase output		
3.2.9	Nominal frequency		
3.2.1 0	Frequency regulation (Without static by-pass source)		
3.2.1 1	Frequency regulation (With static by-pass source)		
3.3	AC standby supply		
3.3.1	Servo controlled voltage stabilizer (SCVS)		
	(a)	Rating	
	(b)	Overload capacity	
	(c)	Input voltage phase & frequency	

	(d)	Percentage voltage regulation	
	(e)	Spike busters / surge suppressors and input filters	
3.3.2	Isolation transformer		
	(a)	Rating	
	(b)	Input voltage phase & frequency	
3.4	Maintenance by pass switch		
4	BATTERY		
4.1	No. of 100% capacity batteries		
4.2	Type of battery cell		
4.3	DC link voltage		
4.4	Battery backup time		
4.5	Mounting Arrangement		
5	RECTIFIER		
5.1	Rectifier unit		
5.2	Parallel Operation		
5.3	Recharge time on battery boost charge		
6	INVERTER		

6.1	Overload Capacity			
6.2	Synchronising			
	- Between inverters			
	- Between inverters and standby supply			
6.3	Parallel Operation			
6.4	Synchronising Range			
7	STATIC SWITCH			
7.1	Maximum transfer time			
7.2	Short time current rating			
8	CIRCUIT BREAKER & LOAD BREAK SWITCHES			
8.1	Type	ACB/MCCB / LOAD BREAK SWITCH		
9	AC DISTRIBUTION BOARD			



9.1	Type	Integral or separate			
9.2	Construction	Modular, single / double front			
9.3	Busbars	Aluminium			
9.4	Incoming	ACB/MCCB			
9.5	Outgoing	MCB/MCCB			
9.6	Cable entry facility	Top / Bottom			

**HVAC WORKS – DATASHEET**

## HVAC SYSTEM –TECHNICAL DATA SHEETS

### VRF UNIT

SL. NO.	ITEM	UNIT	
1.0	<b><u>GENERAL</u></b>		
1.1	DESIGNATION		VRF SYSTEM FOR
1.2	MAKE AND MODEL NUMBER		
1.3	NUMBER OFFERED	Nos.	
1.4	TAG NUMBERS		
1.5	COOLING CAPACITY	(BTU/Hr )	
1.6	POWER INPUT AT COOLING CAPACITY	KW	
1.7	CONDENSING TEMPERATURE AND PRESSURE	Deg.C and bar	
1.8	TEMPERATURE OF LIQUID REFRIGERANT AT THE OUTLET OF SUB-COOLER	Deg.C	
1.9	PLACE OF MANUFACTURE		
1.10	CAPACITY OF EACH VRF SYSTEM AT DESIGNCONDITIONS	TR	
1.11	REFRIGERANT		R407C / R410A
1.12	EACH VRF UNIT SIZE (L xWx H) AND NUMBER OF UNITS	Mm	
1.13	CLEARNACE REQUIRED		
1.13.1	FRONT	Mm	
1.13.2	BACK	Mm	
1.13.3	SIDE	Mm	
1.13.4	TOP	Mm	
1.14	DRY WEIGHT	Kg	
1.15	OPERATING WEIGHT	Kg	

SL. NO.	ITEM	UNIT	
1.16	NOISE LEVEL AT 1.5 m DISTANCE		
1.16.1	OUTDOOR UNIT	dBA	
1.17	NUMBER OF REFRIGERATION CIRCUITS	Nos.	
1.18	TOTAL INPUT POWER AT DESIGN CONDITIONS/VOLTAGE	kW/V	
2.0	<b><u>COMPRESSOR</u></b>		
2.1	TYPE		HERMETIC/ SEMI-HERMETIC/SCROLL
2.2	NUMBER OF COMPRESSORS	Nos.	
2.3	MAKE AND MODEL NUMBER		
2.4	PLACE OF MANUFACTURE		
2.5	SUCTION TEMPERATURE	°C	
2.6	SUCTION PRESSURE	kg/cm <sup>2</sup> (g)	
2.7	CONDENSING TEMPERATURE	°C	
2.8	CONDENSING PRESSURE	kg/cm <sup>2</sup> (g)	
2.9	OPERATING SPEED	RPM	
2.10	INPUT POWER AT DESIGN CONDITION	KW	
2.11	MOTOR RATING	KW	
2.12	CAPACITY CONTROL AVAILABLE		YES / NO
2.13	IN STEPS OF IF YES		
3.0	<b><u>BLOWER SECTION</u></b>		
3.1	FAN		
3.1.1	NUMBER OF FANS		
3.1.2	MAKE AND MODEL NUMBER		
3.1.3	CAPACITY OF EACH FAN	m <sup>3</sup> /hr	
3.1.4	STATIC PRESSURE	mm WC	

SL. NO.	ITEM	UNIT	
3.1.5	STATIC PRESSURE EXTERNAL TO THE PAC	mm WC	
3.1.6	DISCHARGE DIRECTION		HORIZONTAL/VERTICAL UP/DOWN
3.1.7	IMPELLER SPEED	RPM	
3.1.8	OUTLET VELOCITY	m/s	
3.1.9	IMPELLER MATERIAL		
3.1.10	BRAKE POWER	kW	
3.1.11	POWER INPUT TO MOTOR AT DUTY POINT	kW	
3.1.12	MOTOR RATING	kW	
3.1.13	MOTOR MAKE		
3.2	DX COOLING COIL		
3.2.1	NUMBER OF COOLING COILS	Nos.	
3.2.2	SENSIBLE COOLING CAPACITY AT DESIGN CONDITIONS	kCal/hr	
3.2.3	LATENT COOLING CAPACITY AT DESIGN CONDITIONS	kCal/hr	
3.2.4	FACE AREA	m <sup>2</sup>	
3.2.5	TUBE OUTSIDE DIAMETER AND THICKNESS	mm	
3.2.6	NUMBER OF ROWS DEEP	Nos.	
3.2.7	NUMBER OF FINS PER CENTIMETER	Nos.	
3.2.8	AIR FACE VELOCITY	m/s	
3.2.9	AIR SIDE PRESSURE DROP	mm WC	
3.3	FILTERS		
3.3.1	NUMBER OF FILTERS		
3.3.2	MAKE AND MODEL NUMBER		
3.3.3	FILTER MATERIAL		

SL. NO.	ITEM	UNIT	
3.3.4	OVERALL SIZE OF EACH FILTER- L×W	mm	
3.3.5	AIR SIDE PRESSURE DROP AT RATED CAPACITY	mm WC	
3.3.6	EFFICIENCY OF FILTER		
4.0	<b><u>CONDENSER</u></b>		
4.3.1	NUMBER OF CONDENSERS		
4.3.2	MAKE AND MODEL NUMBER		
4.3.3	HEAT REJECTION CAPACITY AT DESIGNCONDITIONS	kCal/hr.	
4.3.4	OVERALL SIZE OF FAN AND COIL UNIT OF EACH CONDENSER: L ×W×H	mm	
4.3.5	MAXIMUM PERMISSIBLE DISTANCE BETWEEN CONDENSER AND INSIDE UNIT (VERTICAL & TOTAL)	m	
4.3.6	CONDENSER FANS		
a)	NUMBERS IN EACH CONDENSER	Nos.	
b)	CAPACITY OF EACH FAN	m <sup>3</sup> /hr.	
c)	STATIC PRESSURE	mm WC	
d)	IMPELLER MATERIAL		
e)	BRAKE POWER OF EACH FAN	kW	
f)	INPUT POWER OF EACH FAN	kW	
g)	MOTOR RATING OF EACH FAN	kW	
5.0	<b><u>ACCESSORIES</u></b>		
5.1	TYPE OF VIBRATION ISOLATORS		
5.2	REMOTE CONTROLLER		
5.3	FUNCTIONS		
5.4	FILTER MAINTENANCE TIME		

SL. NO.	ITEM	UNIT	
5.5	FAULT CODE DISPLY		
5.6	FACILITY TO CONNECT TO A SECOND (SUB) CONTROLLER		
6.0	<b><u>MAKES</u></b>		
6.1	THERMOSTATIC EXPANSION VALVE		
6.2	HIGH AND LOW PRESSURE CUT OUTS		
6.3	THERMOSTAT		
6.4	HUMIDISTAT		
7.0	<b><u>PERFORMANCE GUARANTEE</u></b>		
7.1	CAPACITY AT DESIGN CONDITIONS	TR	
7.2	TOTAL POWER INPUT AT DESIGN CONDITIONS	kW	
7.3	BLOWER		
7.4	STATIC PRESSURE EXTERNAL	mm WC	
7.5	DEHUMIDIFIED AIR FLOW CAPACITY AT SPECIFIED EXTERNAL STATIC PRESSURE	m <sup>3</sup> /hr.	
7.6	NOISE LEVEL AT 1.5m DISTANCE FROM		
7.6.1	VRF OUTDOOR UNIT	dBA	

**PRECISION AC UNITS**

A	GENERAL		
1	DESIGNATION		PRECISION AC FOR
2	MAKE AND MODEL NUMBER		
3	NUMBER OFFERED	W + S	
4	TAG NUMBERS		

5	COOLING CAPACITY	(BTU/Hr)	
6	POWER INPUT AT COOLING CAPACITY	KW	
	REFRIGERANT		R407C / R410A
<b>B</b>	<b>INDOOR UNIT</b>		
1	NUMBER OF BAY	--	
2	NUMBER OF CIRCUITS	--	
3	CASING MATERIAL	--	
4	SKIN	--	
5	TYPE OF UNIT:		
	FLOOR MOUNTED		
	TOP DISCHARGE / BOTTOM DISCHARGE		
6	COMPRESSOR:		
	MAKE	--	
	TYPE	--	
	MODEL NO.	--	
	NO OF COMPRESSOR / UNIT	NOS.	
	POWER SUPPLY	V / PH / HZ	
	CAPACITY CONTROL ARRANGEMENT	%	
	METHOD OF LUBRICATION	--	
	GRADE OF LUBRICATION OIL	--	
	STARTING & UNLOADING ARRANGEMENT	--	
	MOTOR RPM	RPM	
	MOTOR CLASS OF INSULATION	--	
	MOTOR PROTECTION	--	
7	EVAPORATOR COIL:		
	MAKE	--	
	TYPE	--	
	NO OF COIL / UNIT	--	
	ROWS DEEP	NOS.	
	FACE AREA	M2	



	FINS PER INCH	NOS.	
	TUBE MATERIAL / SIZE / THICK	-- / MM / MM	
	FIN MATERIAL / THICK	-- / MM	
<b>8</b>	<b>REFRIGERANT CONNECTIONS:</b>		
	GAS CONNECTION (OD)	MM	
	LIQUID CONNECTION (OD)	MM	
<b>9</b>	<b>EVAPORATOR FAN:</b>		
	MAKE	--	
	TYPE OF FAN	--	
	MATERIAL FAN / FRAME	--	
	TYPE OF DRIVE	--	
	FAN DIAMETER	MM	
	NO OF FAN / UNIT	NOS.	
	POWER SUPPLY	V / PH / HZ	
	MOTOR RPM	RPM	
	MOTOR CLASS OF INSULATION	--	
	MOTOR PROTECTION	--	
	TYPE OF BEARING	--	
	BEARING LUBRICATION	--	
<b>10</b>	<b>EXPANSION VALVE:</b>		
	MAKE	--	
	TYPE	--	
<b>11</b>	<b>FILTERS:</b>		
	MAKE	--	
	TYPE	--	
	SIZE	MM	
	QTY.	NOS.	
	FILTRATION EFFICIENCY (% / MICRON SIZE)		
	PRESSURE DROP (CLEAN CONDITION)	MM WC	

	PRESSURE DROP (DIRTY CONDITION)	MM WC	
<b>12</b>	<b>ELECTRICAL HEATER:</b>		
	MAKE	--	
	CAPACITY	KW	
	POWER SUPPLY	V / PH / HZ	
<b>13</b>	<b>DIMENSION AND WEIGHT:</b>		
	WIDTH	MM	
	DEPTH	MM	
	HEIGHT	MM	
	FOOTPRINT	MM <sup>2</sup>	
	WEIGHT (AIR COOLED)	KG	
	WEIGHT (WATER COOLED)	KG	
<b>B</b>	<b>AIR COOLED CONDENSER</b>		
	NUMBER OF CIRCUIT'S	--	
<b>14</b>	<b>CONDENSER COIL:</b>		
	MAKE	--	
	TYPE	--	
	FACE AREA	M <sup>2</sup>	
	AIR VOLUME	M <sup>3</sup> / HR	
	ROWS DEEP	NOS.	
	FINS PER INCH	NOS.	
	TUBE MATERIAL / SIZE / THICK	-- / MM / MM	
	FIN MATERIAL / SIZE / THICK	-- / MM / MM	
<b>15</b>	<b>CONDENSER FAN:</b>		
	MAKE	--	
	TYPE OF FAN	--	
	FAN MATERIAL	--	
	TYPE OF DRIVE	--	
	NO OF FAN / CONDENSER	NOS.	
	IMPELLER DIAMETER	MM	

	POWER SUPPLY	V / PH / HZ	
	MOTOR RATED KW	KW	
	FULL LOAD AMPS (FLA)	AMPS.	
	MOTOR RPM	RPM	
	MOTOR CLASS OF INSULATION	--	
	MOTOR PROTECTION	--	
<b>16</b>	<b>DIMENSION AND WEIGHT:</b>		
	CASING MATERIAL	--	
	VERTICAL DISCHARGE		
	WIDTH	MM	
	DEPTH	MM	
	HEIGHT	MM	
<b>17</b>	<b>WEIGHT</b>	KG	

**AXIAL FLOW FAN**

DATASHEET A			
<b>1.0</b>	<b>GENERAL</b>		
1.1	DESIGNATION		AXIAL FANS FOR SUPPLY / EXHAUST
1.2	NUMBER REQUIRED		
1.3	TAG NUMBERS		
1.4	LOCATION		
1.5	DUTY		CONTINUOUS
1.6	LOCATION IN HAZARDOUS AREA		
1.7	HAZARDOUS AREA CLASSIFICATION		
<b>2.0</b>	<b>DESIGN DATA</b>		
2.1	CAPACITY AT SUCTION		

<b>DATASHEET A</b>			
	CONDITIONS		
2.1.1	NORMAL	M <sup>3</sup> /Hr	
2.1.2	MINIMUM	M <sup>3</sup> /Hr	
2.1.3	MAXIMUM	M <sup>3</sup> /Hr	
2.2	GAS HANDLED		AIR
2.3	GAS CONDITION AT SUCTION		
2.3.1	TEMPERATURE		
2.3.2	RELATIVE HUMIDITY		AMBIENT
2.3.3	DENSITY	kg/M <sup>3</sup>	
2.4	STATIC PRESSURE	mmWC	
2.5	MAXIMUM FAN SPEED		
2.5.1	FOR IMPELLER DIAMETER 450 mm AND LESS		1500 RPM
2.5.2	FOR IMPELLER DIAMETER ABOVE 450 mm		1000 RPM
2.6	DESIGN AMBIENT TEMPERATURE		
2.7	ELEVATION ABOVE MEAN SEA LEVEL	M	
<b>3.0</b>	<b>CONSTRUCTION FEATURES</b>		
3.1	TYPE		TUBE AXIAL / PROPELLER
3.2	SPARK PROOF CONSTRUCTION TYPE		AS PER AMCA A / B / C
3.3	DRIVE		DIRECT
3.4	ADJUSTABLE PITCH BLADES REQUIRED		NO

<b>DATASHEET A</b>			
3.5	TYPE OF MOUNTING		WALL / IN DUCT
3.6	PAINTING		AS PER IS STANDARD
<b>4.0</b>	<b>MATERIAL OF CONSTRUCTION</b>		
4.1	CASING		CS
4.2	IMPELLER		CAST AL
4.3	SHAFT		EN 8
4.4	INLET CONE OR BELL		MS
4.5	OUTLET CONE		MS
4.6	GUIDE VANE		
<b>5.0</b>	<b>ACCESSORIES</b>		
5.1	FLEXIBLE CONNECTION AT FAN OUTLET		FOR TUBE AXIAL FAN - YES
5.2	SOLATION DAMPERS AT FAN INLET /		YES
5.3	INLET CONE OR BELL AND OUTLET CONE		FOR SUPPLY AIR FAN YES
5.4	LOUVERED SHUTTERS		FOR EF YES
5.5	WALL COWL WITH BIRD SCREEN		FOR SUPPLY AIR FAN YES
5.6	FLEXIBLE COUPLING AND COUPLING GUARD		NO
5.7	WOODEN BLOCK FOR MOUNTING		NO
5.8	COMMON BASE FRAME OR SUPPORTING FRAME FOR MOUNTING		YES
5.9	NEOPRENE RUBBER PADS		YES
5.10	FOUNDATION BOLTS		YES

<b>DATASHEET A</b>			
5.11	VIBRATION ISOLATORS		YES
5.12	RIBBED NEOPRENE RUBBER PADS BETWEEN FOUNDATION BLOCK AND FLOOR FOR FLOOR MOUNTED FANS		NO
<b>6.0</b>	<b>MOTOR DATA</b>		
6.1	MOTOR BY		
6.2	STARTER BY		
<b>7.0</b>	<b>TESTING &amp; INSPECTION</b>		
7.1	TESTING & INSPECTION		AS PER IS STANDARD

<b>DATASHEET B</b>			
<b>GENERAL</b>			
1.1	DESIGNATION		AXIAL FANS FOR
1.2	NUMBER REQUIRED		
1.3	TAG NUMBERS		
1.4	LOCATION		
1.5	DUTY		
<b>DESIGN DATA</b>			
2.1	CAPACITY AT SUCTION CONDITIONS		
2.1.1	NORMAL	M <sup>3</sup> /Hr	
2.1.2	MINIMUM	M <sup>3</sup> /Hr	
2.1.3	MAXIMUM	M <sup>3</sup> /Hr	
2.2	GAS HANDLED		AIR

<b>DATASHEET B</b>			
2.3	GAS CONDITION AT SUCTION		
2.3.4	TEMPERATURE		
2.3.5	RELATIVE HUMIDITY		
2.3.6	DENSITY	kg/m <sup>3</sup>	
2.4	STATIC PRESSURE	mmWC	
2.5	MAXIMUM FAN SPEED		
2.5.3	FOR IMPELLER DIAMETER 450 mm AND LESS		
2.5.4	FOR IMPELLER DIAMETER ABOVE 450 mm		
2.6	DESIGN AMBIENT TEMPERATURE		
2.7	ELEVATION ABOVE MEAN SEA LEVEL	M	
<b>CONSTRUCTION FEATURES</b>			
3.1	TYPE		
3.2	SPARK PROOF CONSTRUCTION TYPE		
3.3	DRIVE		
3.4	ADJUSTABLE PITCH BLADES REQUIRED		
3.5	TYPE OF MOUNTING		
3.6	PAINTING		
<b>MATERIAL OF CONSTRUCTION</b>			
4.1	CASING		
4.2	IMPELLER		

<b>DATASHEET B</b>			
4.3	SHAFT		
4.4	INLET CONE OR BELL		
4.5	OUTLET CONE		
4.6	GUIDE VANE		
<b>ACCESSORIES</b>			
5.1	FLEXIBLE CONNECTION AT FAN OUTLET		FOR TUBE AXIAL FAN - YES
5.2	SOLUTION DAMPERS AT FAN INLET /		YES
5.3	INLET CONE OR BELL AND OUTLET CONE		FOR SUPPLY AIR FAN YES
5.4	LOUVERED SHUTTERS		FOR EXHAUST YES
5.5	WALL COWL WITH BIRD SCREEN		FOR SUPPLY AIR FAN YES
5.6	COMMON BASE FRAME OR SUPPORTING FRAME FOR MOUNTING		YES
5.7	NEOPRENE RUBBER PADS		YES
5.8	FOUNDATION BOLTS		YES
5.9	VIBRATION ISOLATORS		YES
5.10	RIBBED NEOPRENE RUBBER PADS BETWEEN FOUNDATION BLOCK AND FLOOR FOR FLOOR MOUNTED FANS		NO
<b>ELECTRICAL</b>			
6.1	MOTOR BY		
6.2	STARTER BY		



<b>DATASHEET B</b>			
6.3	POWER REQUIREMENT		
6.3.1	POWER INPUT TO FAN AT DUTY POINT (BKW)	kW	
6.3.2	MAXIMUM POWER REQUIREMENT AT SELECTED SPEED	kW	
6.3.3	MOTOR RATING	kW	
6.3.4	POWER INPUT TO MOTOR AT DUTY POINT	kW	
	<b>DOCUMENTS TO BE ENCLOSED</b>		WHETHER ENCLOSED
7.1	GENERAL ARRANGEMENT DRAWING WITH MAJOR DIMENSIOND		YES / NO
7.2	PART LIST WITH CODES AND MATERIALS OF CONSTRUCTION		YES / NO
7.3	RATING CHARTS OR TABLES WITH SELECTION MARKED		YES / NO
7.4	PERFORMANCE CURVE WITH DUTY POINT MARKED		YES / NO
	<b>PERFORMANCE GRARANTEES</b>		
8.1	CAPACITY AT SUCTION CONDITIONS	M <sup>3</sup> /Hr	
8.2	STATIC PRESSURE	mmWC	
8.3	POWER CONSUMPTION	kW	

**AIR DISTRIBUTION SYSTEM**

<b>DATASHEET A</b>			
<b>1.0</b>	<b>GENERAL</b>		
1.1	DESIGNATION		AIR DISTRIBUTION SYSTEM

<b>DATASHEET A</b>			
<b>2.0</b>	<b>DUCTING</b>		
2.1	RECTANGULAR DUCTING		YES
2.2	MATERIAL		GSS
2.3	QUANTITY		
	DUCT GAUGE		
	24 G	SQ.M	
	22 G	SQ.M	
	20 G	SQ.M	
	18 G	SQ.M	
<b>3.0</b>	<b>DIFFUSERS</b>		
3.1	DIFFUSERS WITH VOLUME CONTROL DAMPER		YES
3.1.1	TYPE		SQUARE
3.1.2	PATTERN		FLUSH
3.1.3	MATERIAL		AL WITH POWDER COATED
3.1.4	QUANTITY		
	TYPE	NOS	SIZE, mm
	RECTANGULAR/SQUARE		
	RECTANGULAR/SQUARE		
i)	SQUARE DIFFUSERS	SQ.M	
ii)	SLOT DIFFUSER	SQ.M	
3.2	DIFFUSERS WITHOUT VOLUME CONTROL DAMPER		FOR RETURN AIR
3.2.1	TYPE		SQUARE (S)
3.2.2	PATTERN		FLUSH

<b>DATASHEET A</b>			
3.2.3	MATERIAL		AL WITH POWDER COATED
3.2.4	QUANTITY		
	TYPE	NOS	SIZE, mm
	RECTANGULAR/SQUARE		
	RECTANGULAR/SQUARE		
i)	ROUND DIFFUSERS	SQ.M	
ii)	SQUARE DIFFUSERS	SQ.M	
iii)	LINEAR DIFFUSERS	SQ.M	
iv)	SLOT DIFFUSERS	SQ.M	
<b>4.0</b>	<b>GRILLES</b>		
4.1	GRILLES WITH VOLUME CONTROL DAMPER		
4.1.1	TYPE		DOUBLE ACTING
4.1.2	MATERIAL		CS WITH RUST RESIST. PRIMER/AL WITH POWDER COATING
4.1.3	QUANTITY	M <sup>2</sup>	
4.2	GRILLES WITHOUT VOLUME CONTROL DAMPER		
4.2.1	TYPE		FIXED BLADE / ADJUSTABLE BLADE
4.2.2	MATERIAL		CS WITH RUST RESIST. PRIMER/AL
4.2.3	QUANTITY	M <sup>2</sup>	
<b>5.0</b>	<b>DAMPERS</b>		
5.1	OPPOSED BLADE TYPE VOLUME CONTROL DAMPER FOR RECTANGULAR DUCT	M <sup>2</sup>	

<b>DATASHEET A</b>			
	WITH BRASS BUSHING		
5.2	MOTORIZED DAMPER		YES
5.2.1	SHAFT BLADE TO BE PROVIDED WITH		BRASS BUSHING / TEFLON BUSHING / SEALED BALL BEARING
5.2.2	FOR RECTANGULAR DUCT	M <sup>2</sup>	
5.3	FIRE DAMPERS		YES
5.3.1	TYPE		MOTORISED
5.3.2	QUANTITY	QTY	
<b>6.0</b>	<b>INSULATION</b>		
6.1	ACOUSTIC INSULATION		YES
6.1.1	MATERIAL		REF. TECHNICAL SPECIFICATION
6.1.2	DENSITY	kg/M <sup>3</sup>	
6.1.3	THICKNESS	mm	REF. TECHNICAL SPECIFICATION
6.1.4	QUANTITY	M <sup>2</sup>	
6.2	THERMAL INSULATION		YES
6.3	COMPANION SPECIFICATION		REF. TECHNICAL SPECIFICATION
<b>7.0</b>	<b>MISCELLANEOUS</b>		
7.1	PLENUM		YES
7.2	QUANTITY		AS PER AC LAYOUT
7.3	ACCESS DOORS TO BE PROVIDED		YES
7.4	FLEXIBLE CONNECTION OTHER THAN AT EQUIPMENT INLET AND OUTLET	M <sup>2</sup>	

<b>DATASHEET A</b>			
7.5	FRAME WORK FOR, GRILLES, WALL MOUNTED VCD AND FIRE DAMPERS		CS / SS BY BIDDER
7.6	DUCT SUPPORTS QUALIFIED FOR SEISMIC FORCES		YES
<b>8.0</b>	<b>TESTING &amp; INSPECTION</b>		
8.1	TESTING & INSPECTION		AS PER IS STANDARD

<b>DATASHEET B</b>			
<b>1.0</b>	<b>GENERAL</b>		
1.1	DESIGNATION		AIR DISTRIBUTION SYSTEM FOR
<b>2.0</b>	<b>DUCTING</b>		
2.1	TYPE		RECTANGULAR
2.2	MATERIAL		GSS / AL / SS 304
2.3	TYPE		ROUND
	MATERIAL		GSS / AL / SS 304
	SEAM		SPIRAL / LONGITUDINAL
<b>3.0</b>	<b>DIFFUSERS</b>		
3.1	DIFFUSER WITH VOLUME CONTROL DAMPER		YES / NO
3.1.5	TYPE		ROUND / SQUARE / LINEAR / SLOT
3.1.6	PATTERN		FLUSH / STEPPED
3.1.7	MATERIAL		CS WITH RUST RESISTANT PRIMER / AL WITH POWDER COATED / SS 304
3.2	DIFFUSER WITHOUT VOLUME CONTROL DAMPER		YES / NO

<b>DATASHEET B</b>			
3.2.1	TYPE		ROUND / SQUARE / LINEAR / SLOT
3.2.2	PATTERN		FLUSH / STEPPED
3.2.3	MATERIAL		CS WITH RUST RESISTANT PRIMER / AL WITH POWDER COATED / SS 304
<b>4.0</b>	<b>GRILLES</b>		
4.1	GRILLES WITH VOLUME CONTROL DAMPER		YES / NO
4.1.4	TYPE		SINGLE ACTING / DOUBLE ACTING
4.1.5	MATERIAL		CS WITH RUST RESIST. PRIMER / AL WITH POWDER COATING / SS304
4.1.6	QUANTITY	M <sup>2</sup>	
4.2	GRILLES WITHOUT VOLUME CONTROL DAMPER		
4.2.4	TYPE		FIXED BLADE / ADJUSTABLE BLADE
4.2.5	MATERIAL		CS WITH RUST RESIST. PRIMER/AL
4.2.6	QUANTITY	M <sup>2</sup>	
<b>5.0</b>	<b>DAMPERS</b>		
5.1	OPPOSED BLADE TYPE VOLUME CONTROL DAMPER FOR RECTANGULAR DUCT WITH BRASS BUSHING	M <sup>2</sup>	YES / NO
5.2	MOTORIZED DAMPER		YES / NO
5.2.3	SHAFT BLADE TO BE PROVIDED WITH		BRASS BUSHING / TEFLON BUSHING / SEALED BALL BEARING
5.2.4	FOR RECTANGULAR DUCT	M <sup>2</sup>	

<b>DATASHEET B</b>			
5.3	FIRE DAMPERS		YES / NO
5.3.3	TYPE		MOTORISED
<b>6.0</b>	<b>INSULATION</b>		
6.1	ACOUSTIC INSULATION		YES / NO
6.1.5	MATERIAL		
6.1.6	DENSITY	kg/M <sup>3</sup>	
6.1.7	THICKNESS	mm	
6.1.8	QUANTITY	M <sup>2</sup>	
6.2	THERMAL INSULATION		YES / NO
6.3	MATERIAL		REF. TECHNICAL SPECIFICATION
6.4	DENSITY	kg/M <sup>3</sup>	
6.5	THICKNESS	mm	
6.6	THERMAL CONDUCTIVITY	Kcal / hr m deg C	
<b>7.0</b>	<b>MISCELLANEOUS</b>		
7.1	PLENUM		YES / NO
7.2	ACCESS DOORS		YES / NO
7.3	FLEXIBLE CONNECTION OTHER THAN AT EQUIPMENT INLET AND OUTLET	M <sup>2</sup>	YES / NO
7.4	FRAME WORK FOR, GRILLES, WALL MOUNTED VCD AND FIRE DAMPERS		CS / SS
7.5	DUCT SUPPORTS QUALIFIED FOR SEISMIC FORCES		YES / NO
7.6	PAINTING		YES / NO

DATASHEET B			
7.7	DUCTS		UNPAINTED /EPOXY / SYNTHETIC ENAMEL
7.8.1	DUCT SUPPORTS		RED OXIDE PRIMER / EPOXY / SYNTHETIC ENAMEL
7.8.2	DIFFUSERS IN CASE OF CS		UNPAINTED / EPOXY
7.8.3	GRILLES IN CASE OF CS		UNPAINTED / EPOXY

**INSULATION**

DATASHEET A			
<b>1.0</b>	<b>GENERAL</b>		
1.1	PIPES : REFRIGNERANT SUCTION AND LIQUID LINES		REF. TECHNICAL SPECIFICATION
1.2	AIR-CONDITIONING SYSTEMS ENTIRE SUPPLY AND RETURN AIR DUCT		REF. TECHNICAL SPECIFICATION
1.3	INSULATION ADHESIVE		CPR X COMPOUND
1.4	FINISHING		AS PER IS STANDARD

DATASHEET B			
<b>1.0</b>	<b>GENERAL</b>		
1.1	INSULATION MATERIALS		
1.1.1	EQUIPMENT		
1.1.2	PIPING SYSTEMS		
1.1.3	AIR-CONDITIONING DUCT		
1.2	INSULATION ADHESIVES		



<b>DATASHEET B</b>			
1.3	VAPOUR BARRIERS		
1.4	FINISHING MATERIALS		
1.4.1	EQUIPMENT		
1.4.2	PIPING SYSTEMS		
1.4.3	AIR-CONDITIONING DUCT		
1.5	DENSITY OF EACH OF THE INSULATING MATERIALS	kg/M <sup>3</sup>	
1.6	IS ANY INSULATION MATERIAL CORROSIVE TO CARBON STEEL OR ALLOY STEEL SURFACE IN CONTACT		YES / NO
1.7	INSULATION THICKNESSES FOR ALL INSULATION MATERIALS SELECTED, IN THE FORMAT SIMILAR TO THAT IN DATA SHEET A, TO BE ENCLOSED.		WHETHER ENCLOSED YES / NO

### **FILTER**

<b>DATASHEET A</b>			
<b>1.0</b>	<b>GENERAL</b>		
1.1	DESIGNATION		
1.2	SERVICE		AMBIENT AIR FOR AC SYSTM / /VENTILATION SYSTEM
1.3	APPLICATION		
1.4	TYPE		CASSETTE / FLANGE
1.5	CLEANING METHOD		CLEANABLE

<b>DATASHEET A</b>			
<b>2.0</b>	<b>DESIGN DATA</b>		
2.1	TOTAL AIR FLOW RATE	M <sup>3</sup> /Hr	
2.2	TEMPERATURE OF AIR	°C	
2.3	RELATIVE HUMIDITY	%	
2.4	DUST LOADING	gm/M <sup>3</sup>	
2.5	EFFICIENCY		90% DOWN TO 10 MICRONS
2.6	TYPE OF CONTAMINATION		RADIO ACTIVE / CORROSIVE
2.7	MAXIMUM FILTER FACE VELOCITY	M/sec	2.5 FOR PRE FILTER 1.8 FOR FINE FILTER (FOR 150 MM) 2.4 FOR FINE FILTER (FOR 300 MM)
2.8	TOTAL FACE AREA OF FILTERS REQUIRED		
2.9	FILTER MEDIA		SYNTHETIC FIBRE / HDPE / GLASS FIBRE PAPER
2.10	LIFE OF FILTER MEDIA FOR THROW AWAY	Hrs	
2.11	PREFERRED SIZE OF EACH FILTER PANEL :		610 mm x 610 mm x 50 mm THK
2.12	NUMBER OF FILTER PANELS		
2.13	WEIGHT OF EACH FILTER	kg	
2.14	MAXIMUM ALLOWABLE PRESSURE DROP FOR DESIGN FLOW RATE IN		
2.14.1	CLEAN CONDITION	mmWC	
2.14.2	CLOGGED CONDITION	mmWC	
<b>3.0</b>	<b>MATERIAL CONSTRUCTION OF</b>		

<b>DATASHEET A</b>			
3.1	MOUNTING FRAME / SUPPORTING FRAME WORK FOR FILTER ASSEMBLY		GSS/ HOT DIP GALVANISED
3.2	GASKETS FOR FILTER ASSEMBLY		NEOPRENE RUBBER
3.3	FASTENERS		GS / SS
<b>4.0</b>	<b>TESTING &amp; INSPECTION</b>		
4.1	TESTING AT WORKS		EFFICIENCY AND PRESSURE DROP FOR ALL FILTERS
4.2	TESTING AT SITE		EFFICIENCY AND PRESSURE DROP, LEAKAGE AND FILTER BANK LEAKAGE

<b>DATASHEET B</b>			
<b>1.0</b>	<b>GENERAL</b>		
1.1	DESIGNATION		
1.2	APPLICATION		PRE / FINE
1.3	TYPE		CASSETTE/FLANGE
1.4	MANUFACTURER		
1.5	MODEL NUMBER		
1.6	WHETHER CLEANABLE		YES / NO
1.7	CLEANING METHOD		
1.7.1	REMOVAL AND CLEANING IN REMOTE PLACE BY AIR JET / WATER		YES / NO
1.7.1.1	AIR/WATER PRESSURE REQUIRED	kg/cm <sup>2</sup> g	
1.7.2	MECHANICAL CLEANING IN-SITE (WITHOUT REMOVING FILTERS) BY REVERSE COMPRESSED AIR JET		YES / NO

<b>DATASHEET B</b>			
1.7.2.1	AIR PRESSURE REQUIRED	kg/cm <sup>2</sup> g	
1.8	FILTER MEDIA		SYNTHETIC FIBRE / HDPE /
			GLASS FIBRE PAPER
1.9	LIFE OF FILTER MEDIA FOR THROW AWAY TYPE	Hrs	
1.10	DUST LOADING CAPACITY	gms	PER FILTER
<b>2.0</b>	<b>DESIGN DATA</b>		
2.1	TOTAL FACE AREA OF FILTERS	M <sup>2</sup>	
2.2	NUMBER OF FILTERS		
2.3	SIZE OF EACH FILTER L x B x THK	mm	x x
2.4	DESIGN AIR FLOW RATE PER FILTER	M <sup>3</sup> /Hr	
2.5	WEIGHT OF EACH FILTER	kg	
2.6	PRESSURE DROP AT DESIGN FLOW RATE IN		
2.6.1	CLEAN CONDITION	mmWC	
2.6.2	CLOGGED CONDITION	mmWC	
2.7	EFFICIENCY	%	DOWN TO MICRONS
<b>3.0</b>	<b>MATERIAL OF CONSTRUCTION</b>		
3.1	FILTER PANEL FRAME		
3.2	MOUNTING FRAME / SUPPORTING FRAME WORK FOR FILTER ASSEMBLY		
3.3	GASKETS FOR FILTER ASSEMBLY		
3.4	FASTENERS		
<b>4.0</b>	<b>MISCELLANEOUS</b>		

<b>DATASHEET B</b>			
4.1	TYPE AND METHOD OF TESTS AS SPECIFIED ARE ACCEPTABLE		YES / NO
4.2	WHETHER FILTER IS COMPATIBLE WITH THE TYPE OF CONTAMINATION		YES / NO
4.3	SELECTION CHARTS WITH DUTY POINT MARKED FOR CLEAN AND CLOGGED FILTER CONDITION TO BE ENCLOSED		WHETHER ENCLOSED YES / NO

**SCHEDULE D – APPROVED MAKES**

**ARCHITECTURAL WORKS – APPROVED MAKE**

**ARCHITECTURAL WORKS - LIST OF APPROVED MAKES**

<b>SR. NO.</b>	<b>PRODUCT</b>	<b>BRAND, AGENCY OR ANY MAKE APPROVED BY ASSAM PWD</b>
1.	AAC / flyash blocks	Charbuja, Aerocon, Siporex, Ecolite, CEEFpro, BLIT, Approved local brand
2.	GRC	Unistone, Birla White
3.	Concrete Stone Sealar	Degussa, Wacker, Hytek, Aquamix, Laticrete, Kerakoll
4.	Fire Check Wood, Steel Doors	Signum, Godrej, Guardian, Navair, Shakti Hormann, Promat, Alhada,
5.	Flush Doors	Tata Conswood, Green ply, Garnet, Merino, Century
6.	Door seals [ dust / fire ]	Lorient, Enviroseals, Pemko, Assorted
7.	Structural, Weather Sealant	Dow Corning, GE, Dupont
8.	Glazed, Ceramic & Vitrified Tiles	Kajaria, Nitco, Jhonson, RAK
9.	Pigmented Joint fillers	Laticrete, Pidilite
10.	TILES (Chequered Plain cement)	Endura, Nitco, Jhonson
11.	Cement Putty	Birla White, J K white
12.	Paint	Nerolac, Asian Paints, Dulux, Jenson & Nicholson, Berger, ICI, Oikos, Akzonobel, MRF
13.	Glass/ Float glass/ Toughened	Saint Gobain, AIS, Pilkington, Emirates
14.	Patch fittings / friction fittings, Floor spring, Door closer	Dorma/ Hafele/ Geze/ Hettich
15.	Glazing Systems	Hydro, Domal, Kawneer
16.	Fire rated glass	Schott, Saint Gobain, Pyrex
17.	Doors, Window Fittings And Fixtures	Dorma, Giesse, Dline, Union, Yale, Assa Abloy brands
18.	Toughening Agencies	Sejal, GSC, Gold Plus, Impact
19.	Lamination Films	Garware, Dupont
20.	Polycarbonate sheet	Lexan, Danpalon, GE, Tuflite, Plaram
21.	Gypsum & Mineral Fibre boards, systems, access panels & accessories	Saint Gobain, India Gypsum, Rondo, Armstrong, AMF, Knauf, Rehau, Lafarge, Gypsemma, USG
22.	False Floor	Unitile, Solidfeel
23.	Handrails	Technorails, Dline, Dorma, Carlf India,
24.	Acoustic treatment / boards, etc	Anutone, Armstrong
25.	Aluminium Composite Panel	Alu decor / Alucobond /Alstrong



<b>SR. NO.</b>	<b>PRODUCT</b>	<b>BRAND, AGENCY OR ANY MAKE APPROVED BY ASSAM PWD</b>
26.	Vinyl Flooring	Armstrong flooring / Tarket / Ger
27.	Fencing	A1Fence
28.	Polypyopylene Rungs	Pranali, Mase Safety Works, StepX
29.	Paver Blocks	Endura, Spectra, Approved local brand
30.	Grass Pavers	Vyara, Basant Beton
31.	Thermoplastic Road Marking Paint	Asian Paint PPG-Apcomark, Automark Technologies (India) Pvt. Ltd.
32.	Fire Stop Mortar & Foam	Firestop, Hilti, Promat, Newkem
33.	Expansion Joints	CS expansion joints, BASF Eabco, Excel Tech
34.	Cast in Channels	Halfen Deha, Jordhal
35.	Sanitary wares	Hindware, Parryware, Cera, HR Jhonson
36.	Concealed flush tanks / valves	Gebrit, Jaquar, Schell, Commander, Viega, Parryware
37.	Faucets /sanitary fittings	Jaquar, Grohe, Schell,
38.	HDPE drain boards	Doerken, Green global, Pidilite
39.	CPVC plumbing pipes & adhesives	Flowgaurd, Astral ,Ashirwad, Prince
40.	Manhole covers	Neco, Municast,
41.	Light Fittings	Corvi, Bajaj, Philips, Trilux, Schreder,
42.	Gate automation & control	Gandhi automation, Boon Edam
43.	Waterproofing Treatment	Pidilite, BASF
44.	Anchor Fastener	Fischer, Hilti
45.	Entry Mat	Euronics, 3M
46.	Rolling shutters	Gandhi automation, Shakti Hormann, Local Approved vendor
47.	Zinc chromate primer for metal surfaces	Asian Paints, Berger Paints
48.	Patch fittings / friction fittings, Floor spring, Door closer, door locks and handles, Automated Sliding Door sensor	Dorma, Hafele, Geze, Hettich
49.	Soft Fibre Acoustic ceiling	Armstrong, Gyproc, Anutone, Ecophon
50.	Plywood	Century, Green ply , Kitply,
51.	Pre Cast GRC Jali	Unistone, Birla ultratech, Dalal Tiles Industries

SR. NO.	PRODUCT	BRAND, AGENCY OR ANY MAKE APPROVED BY ASSAM PWD
52.	Laminate	Formica /Merino, Greenlam, Century, Royal Touch
53.	Mirror	Modi Guard, Saint Gobain, AIS
54.	Perforated Aluminium screen	Fabricator : Preksha Marketing or approved local vendor
55.	Furniture ( bought out/ modular)	
56.	Workstation	HNI ( BP Ergo) / Featherlight, Godrej
57.	Storage cabinets	HNI ( BP Ergo) / Featherlight, Godrej
58.	Chairs	HNI ( BP Ergo) / Featherlight, Amardeep
59.	Sofa	Featherlight, Godrej
60.	Canteen table & Chair	Featherlight, Godrej, Amardeep
61.	Furniture (Built as per design with carpentry work)	
62.	Display decks, Reception tables, Centre tables, activity tables, Cafe table	Woodcraft / Godrej interio or approved local interior works contractor
63.	Signage	IN'S & OUT or approved local vendor
64.	Blinds	Packman / Swan blinds

**Note** : Bidders to consider any of the approved makes indicated above. If any equivalents are suggested by the bidder, they shall be specifically highlighted in the bid submissions, along with technical documentation supporting compliance / equivalency.

The choice of Final makes shall be made by the client/ consultant.  
The sample or Cat.no. of all types of fixing should be approved before execution.

**CIVIL WORKS – APPROVED MAKE**

**CIVIL AND STRUCTURAL WORKS - LIST OF APPROVED MAKES**

Sr. No	Details of Materials / Equipment		Tender Makes/ Any Assam PWD approved make
1	(a)Cement (Grey)	i)	ACC
		ii)	Ultra Tech
		iii)	JK
		iv)	Birla
		v)	Ambuja
	(b) White Cement	i)	JK
		ii)	Birla
2	Ready Mix Concrete	i)	UltraTech
		ii)	ACC
		iii)	RMCRIPL
		iv)	JK Cement
		v)	Unitech
		vi)	Grasim
		vii)	Lafarge
3	TMT Steel	i)	SAIL
		ii)	TISCON
		iii)	RINL
		iv)	IISCO
		v)	JSW
4	Structural steel	i)	SAIL
		ii)	TISCON
		iii)	RINL
		iv)	IISCO
		v)	JSW
5	Chemical Waterproofing system	ii)	BASF
		iii)	MC-Bauchemie

Sr. No	Details of Materials / Equipment		Tender Makes/ Any Assam PWD approved make
		iii)	Sika
		iv)	Sunanda Specialty Coatings
6	Water proofing compound	i)	CICO
		ii)	Pidilite
		iii)	Laticrete
7	Polysulphide sealant	i)	Pidilite
		ii)	BASF
		iii)	Chemetall-Rai
8	Weather Silicon make and grade	i)	Dow Corning
		ii)	Momentive (GE)
9	Water stops	i)	Hydrotite
		ii)	BASF
		iii)	Hydroswell
10	Adhesives and Grouts	i)	Bal
		ii)	Laticrete
		iii)	KeraKoll
		iv)	Pidilite
11	Fire smoke Seal	i)	Hilti
		ii)	CFS
		iii)	SPWB Joints Spray
12	AAC blocks	i)	BILT Industries Pvt. Ltd.
		ii)	Aerocon
		iii)	Siporex India limited
		iv)	Xtralite
13	Anchor Fasteners/ Bolts	i)	Hilti
		ii)	Fischer
		iii)	Halfen
14	Pipe Clamp/ Supports	i)	Hi-Tech
		ii)	Chilly
		iii)	Mupro
		iv)	Flamco
		v)	Diamond

Sr. No	Details of Materials / Equipment		Tender Makes/ Any Assam PWD approved make
15	Rain Water Outlet	i)	ACO
		ii)	Neer
		iii)	GMGR
		iv)	Kessel
16	Ductile Iron (DI) Pipes	i)	TATA
		ii)	Jindal
		iii)	Electro steel
		iv)	Jai Balaji
17	Strainer	i)	Welfo
		ii)	Sant
		iii)	Emerald
18	Actuators	i)	Danfoss
		ii)	Honeywell
		iii)	Belimo
		iv)	M/S Comet
19	Pipe Fittings & accessories	i)	Asian metal
		ii)	Jyoti enterprises
		iii)	Nippon
29	Water Meter	i)	Actris
		ii)	Capstan
		iii)	Kaycee
		iv)	Kranti

**ELECTRICAL WORKS- APPROVED MAKE**

**ELECTRICAL WORKS – LIST OF APPROVED MAKES/ ANY MAKE BY  
APPROVED BY ASSAM PWD**

<b>Sl. No.</b>	<b>Description</b>	<b>Make</b>
1	Compact Substations along with Distribution Transformer with 33KV Switchgear and LT Distribution board	Siemens L&T C&S or Equivalent
2	Protective relays (Numerical Type)	ABB Siemens Alstom Schneider Electric or Equivalent
3	Protective relays (Electromechanical Type)	ABB Siemens Schneider Electric or Equivalent
4	Auxiliary Relay	Schneider Electric ABB Siemens Alstom or Equivalent
5	Electronic circuit Relay	OEN Omron Allen Bradley PLA or Equivalent
6	Instrument Transformers (CT/PT)	Automatic Electric Indcoil Kappa Precise Pragati ECS
7	L.V Switchgear/Switchboard.- Drawout/Fixed Type (PCC/MCC/PMCC/MLDB/MPDB/ MOVDB/APFC)	All panels shall be Type Tested and As per APWD Approved make list
8	Air circuit breakers	L & T Siemens Schneider Electric ABB C&S or Equivalent
9	MCCB's	L & T Siemens Schneider Electric ABB or Equivalent
10	Change-over switch	C&S Schneider Electric ABB BCH or Equivalent
11	VVVF Drives / Electronic Softstarter	Siemens Allen Bradley (Rockwell Automation)



<b>Sl. No.</b>	<b>Description</b>	<b>Make</b>
		Schneider Electric ABB Danfoss or equivalent
12	LV capacitors (APP)	ABB Epcos Schneider Electric L&T or Equivalent
13	Series Reactors For Capacitors	Universal Cable Powercap Capacitors Madhav Capacitors Epcos or Equivalent
14	APFC Relay / Controller	L&T ABB Epcos Schneider Electric or Equivalent
15	AC Power Contactor	Siemens ABB L&T Schneider Electric or Equivalent
16	DC Power Contactor	BCH Siemens L&T Schneider Electric or Equivalent
17	Auxiliary contactors	Siemens L & T Schneider Electric or Equivalent
18	Bi-metal / Overload Relay	Siemens Schneider Electric L&T ABB or Equivalent
19	Time switch	Siemens Schneider Electric Legrand or Equivalent
20	Timers	Siemens Minilec L&T Legrand Schneider Electric or Equivalent
21	Battery Charger & DCDB	Hitachi Caldyne Automatics Chhabi Electricals HBL Power Systems Amara Raja Chloride Power
22	Luminaire	Philips Ligman Wipro

Sl. No.	Description	Make
		Bajaj Havells Lighting Technology or As per APWD Approved make list
23	LED	NICHIA/CREE/ OSRAM/PHILIPS LUMILEDS
24	Cables H.V. - 33 kV XLPE Insulated	Universal Cables Ltd. KEC International Ltd Havells KEI RPG or Equivalent
25	LT Power Cables/ Earthing Cable	Universal Cables Ltd. KEC International Ltd Polycab LAPP RR Kabel Havells or Equivalent
26	LT Control Cables	Universal Cables Ltd. KEC International Ltd Polycab LAPP RR Kabel Havells or Equivalent
27	Distribution Boards	Siemens C&S Schneider Electric Hensel Legrand ABB or Equivalent
28	MCB, RCCB, RCBO / MCB Isolators	Legrand Siemens Schneider Electric ABB or Equivalent
29	Alarm Annunciators (solid state type with LED illumination) / Facia Annunciator	Digicont Industrial Instruments & Controls Procon Inst. (P) Ltd MTL India Pvt. Ltd. Rochester Instruments System Ltd. IDECIZUMI Minilec Proton Electronics Alstom Yashmun
30	Decorative switches, sockets and metal boxes (single plate arrangement)	Honeywell (MK Electric) Anchor (Panasonic) Havells (Crabtree)
31	Modular switch & socket (wraparound) (twin plate)	As per APWD Approved make list

Sl. No.	Description	Make
	arrangement)	
32	Exhaust Fan / Ventilation Fan	Nadi Usha Almonard Bajaj Crompton Greaves or Equivalent
33	Cable termination/jointing kits	Raychem (Tyco Electronics / RPG) 3M(Cold Shrink/Push-on) ABB Kabeldon
34	Control / selector switch	Kaycee GE Power controls L&T Siemens ABB Schneider Electric or Equivalent
35	Indicating Lamps (Multi-chip LED)	Teknic Controls Vaishno Siemens L & T Schneider Electric or Equivalent
36	Terminal Block / Connectors	Wago / Connectwell / Pheonix / Elmex or Equivalent
37	Control transformer	Indcoil Precise Silkaans NEC Gauss Electricals or Equivalent
38	Semiconductor Fuse	Siemens Schneider Electric (Ferraz Shawmut) Eaton (Cooper Bussmann) GE or Equivalent
39	HRC fuse (Power & Control)	Siemens L&T GE Eaton (Cooper Bussmann) Technoelectric Schneider Electric or Equivalent
40	Pushbuttons	Siemens Schneider Electric (Telemecanique) Teknic Controls L&T Concord Vaishno Electricals or Equivalent
41	Push button station	Siemens Schneider Electric Hensel Bals Gewiss or Equivalent

<b>Sl. No.</b>	<b>Description</b>	<b>Make</b>
42	Non metallic enclosures (including Industrial Receptacles)	Rittal Hensel SCAME Menekkes Bals Siemens Schneider Electric Legrand Gewiss or Equivalent
43	Digital Meter – Ammeter & Voltmeter	Schneider Electric (Conzerv) AE Rishabh Schneider Electric (Power Measurement/ ION) Siemens Masibus or Equivalent
44	Electromechanical – Ammeter & Voltmeter	Automatic Electric MECO IMP Rishabh or Equivalent
45	Load Manager / Multi Function Meter / kWh	Schneider Electric (Conzerv / (Power Measurement / ION) Circutor Rishabh Schneider Electric Alpha (ABB) SEMS (Secure) Electro Industries / GaugeTech or Equivalent
46	Cable lugs	As per APWD Approved make list or Dowells, Commet, Connectwell
47	Cable Glands (safe area - double seal cone grip type)	As per APWD Approved make list
48	Lightning Protection	OBO CAPE FURSE or Equivalent
49	Surge Suppressors	OBO Emerson Furse Erico MTL Schneider Electric ABB Siemens or Equivalent
50	Uninterrupted Power Supply (UPS)	Emerson Network Power (India) Pvt. Ltd. Schneider Electric Fuji Electric , Japan Hitachi

Sl. No.	Description	Make
		Eaton Socomec ABB Delta or Equivalent
51	Floor trunking system (GI trays, troughs & pull boxes) and GI Cable trays	OBO Honeywell Legrand Indiana or As per APWD Approved make list
52	Furniture trunking system / Cable management System	Legrand Schneider Electric Rittal Panduit Honeywell Eubiq or Equivalent
53	UPVC Conduit/JB/flexible conduit/tees/ Bevels,elbow & accessories/fittings	As per APWD Approved make list
54	GI Conduit / Pipes	As per APWD Approved make list
55	MS Conduit	As per APWD Approved make list
56	Casing Capping	As per APWD Approved make list
57	HDPE/ DWC Pipe	Rex, Gemini, Duraline, Alcorr or Equivalent
58	Lighting Controller / Lighting Management System	Lutron Zumtobel Philips Tridonic Atco or Equivalent
59	Lead Acid Battery (Plante / Tubular)	Exide HBL Power Systems Ltd. Amara Raja Batteries Ltd. Hoppecke or Equivalent
60	SMF/VRLA battery	Exide HBL Power Systems Ltd Amara Raja Batteries Ltd. Hoppecke or Equivalent
61	Lighting Poles	As per APWD Approved list
62	Fire Barriers / Sealing	Brattberg Roxtec Signum Navell Multikil OBO or Equivalent
63	Water barriers/sealing system	Roxtec Rayflate (Tyco Electronics) or Equivalent
64	Insulating mats	Electromat Dozz Raychem RPG or Equivalent
65	Choke (for VVVF)	Siemens

Sl. No.	Description	Make
		ABB Danfoss Allen Bradley (Rockwell Automation) Yaskawa or Equivalent
66	Power Supply Unit	Siemens MTL Aplab Pheonix Cosel or Equivalent
67	Voltage / Power / Current / Frequency / Energy Transducer	ABB AE Siemens Schneider Electric Rishabh Masibus or Equivalent
68	Limit Switch	BCH Honeywell Siemens Jay Balaji Wago or Equivalent
69	Diesel Engines	Cummins Caterpillar MTU Mitsubishi or Equivalent
70	EV Charger	Mass tech, ABB, Delta or Equivalent
71	Alternators for DG Sets	Cummins (Stamford ) Leroy Somer, BHEL or Equivalent

**Note:**

1. APWD approved makes are also acceptable, but final decision on selection of make will be at the discretion of GSCL.

**HVAC WORKS – APPROVED MAKE**

**HVAC SYSTEM – PREFERRED MAKE LIST**

<b>Sl. No.</b>	<b>Description</b>	<b>Make/ ANY ASSAM PWD APPROVED MAKE</b>
1	VRF System	Blue Star / Daikin / Mitsubishi / Toshiba / Voltas / LG / Samsung
2	Precision AC Unit	Emerson-Liebert / Batliboi / APC / Uniflair / Stulz / Blue Star
3	Propeller Fan	Alstom / Carryaire / Crompton Greaves / Kruger
4	Tube Axial Fan	Kruger / Nicotra / Systemair / Greenheck / Comefri
5	Air Filters	Clean filter /FMI / Spectrum
6	GI Duct Sheet	Jindal / SAIL / Tata Steel
7	Grilles / Diffusers / Fire Damper / VCD	Air Master / Dynacraft / TSC/ Systemair / Carryaire
8	Refrigerant copper Piping	Nippon / Nissan / Rajco
9	Insulation	
	EPS	Beard sell / Lloyd
	Nitrile Rubber	Aeroflex / Armaflex / Kflex / Armacell



**PHE WORKS – APPROVED MAKE**

**APPROVED MAKES OF PLUMBING MATERIAL**

<b>Sr. No.</b>	<b>Material description</b>		<b>Approved makes/ Assam PWD Approved any make</b>
1.	Vitreous China Sanitary ware	:	Kohler, Hind ware, American standard, Roca
2.	CP Fitting	:	Kohler, Jaguar
3.	CI (Spun) Pipes/fittings	:	NECO /SKF
4.	i) uPVC Pipe & Fittings	:	AKG/Supreme / Jain PVC Pipe / Prince
5.	ii) uPVC SWR Pipes & Fittings	:	AKG/Supreme / Jain PVC Pipe / Prince
6.	CPVC Pipe & Fittings	:	Supreme/Astral / Ajay / Ashirwad
7.	G.I. Pipes/MS pipe	:	Jindal (Hissar) / Prakash Surya / APL Apolo / TATA Steel
8.	G.I. fittings (Malleable)	:	Crescent/Unik / Zoloto 'M' / DRP 'M' / R Brand
9.	W C Pan Connector	:	MC Alpine (UK)/Multikwik (UK)/ Veiga
10.	Stainless Steel Grating	:	Chilly / Camry / Cardin
11.	Ball Valve	:	SANT/CIM/ SKS/RBM & CATY
12.	Butterfly valves	:	SANT/ SKS / AIP
13.	Check Valve Forged Screwed	:	SANT/SKS / AIP
14.	Air Release Valve	:	Sant CIM/Tiemme / Arco
15.	Motorised Valve	:	SANT /Aira / /Deltech
16.	Float Valve (C.I)	:	Sant / Leader/SANT / CSA

17.	PRV	:	Honeywell/ SANT/SKS
18.	Pipe Supports, Clamps	:	Chilly /Camry / Easy flex
19.	Anti-Corrosive Bitumastic Paint	:	Asian/Berger/J&N
20.	Epoxy Paint	:	Asian/Berger /J&N
21.	Pipe Protection for Water Supply Pipes	:	Pypkote / Makpolykote / Coaltek
22.	Pressure Gauges	:	Fiebig / H Guru
23.	Fasteners	:	Hilti / Fischer / Canon
24.	R.C.C Pipe	:	Jain Spun Pipe / Pragati / Dewan Spun Pipe
25.	SFRC Manhole Cover/Grating	:	K.K.Manhole
26.	C.I Manhole Cover (IS: 1726–1991)	:	NECO/Crescent Foundry
27.	D.I. Manhole Cover / Grating	:	NECO / RIF / BIC
28.	Recessed Manhole Cover	:	NECO/RIF/SKF
29.	C.I. Grating	:	NECO/RIF/SKF
30.	Gully Traps	:	Perfect/RK/Anand
31.	Plastic Encapsulated Foot Rests	:	KGM/Patel
32.	Clean out Plug	:	Neer / GMGR
33.	Water Meter	:	Kent / SANT/Actaris
34.	SS Bellows	:	Kanwal.
35.	Rain water Outlet	:	Aco/Neer
36.	GI Pipe Sealment	:	Henkel-LOCTITE 55

37.	Copper Pipes	:	Flowflex / Maxflow
38.	HDPE Pipes & Fittings	:	Kissan / Finolex
39.	SS Pipes	:	Remi / Viega
40.	Paint	:	Asian Paints
41.	Gate Valve / Non-return Valve	:	Audco / Sanders
42.	Foot Valve	:	Kirloskar / Hawa
43.	Check Valve – Dual Plate	:	Advance/SANT
44.	Check Valve – Wafer Type	:	Advance/SANT
45.	Flow Control Devices	:	Aquaplug / Con-serve / Jaquar / RST
46.	Floor Drain Fixture & Channel Gratings	:	ACO / GMGR / Neer
47.	Floor trap frame & grating	:	Neer (Material : SS)
48.	'Y' Strainer	:	Emerald / Zoloto
49.	Pumps	:	Kirloskar / Grundfos / Flowmore / Mather & Platt
50.	Booster pumps with pressure tanks	:	Grundfos
51.	Storm water / sewage submersible pumps	:	Grundfos / KSB Pumps Ltd.
52.	Hydro-pneumatic System	:	DP / Grundfos
53.	Transfer Pumps	:	Grundfos
54.	Self-Priming Pumps	:	Johnson / Kirloskar
55.	Domestic Water Lift Pumps	:	DP / Grundfos
56.	Mechanical Seal	:	Burgmann / Sealol

57.	Couplings	:	Lovejoy
58.	Anti Vibration Mounting & Flexible Connection	:	Dunlop / Flexionics / Easyflex
59.	Water Tank/Plastic Steps	:	KGM / Patel / Pranali Industries
60.	Electronic Flow Meter	:	Krohne (forbes Marshall) / Rockwin
61.	U. V. Sterlizer	:	Alfa / Goodlife / Pentair
62.	Welding Electrode	:	Advani Oerlikon / Esab
63.	Fire Sealant	:	Birla 3 M / Hilti / Promat
64.	Level Controller & Indicator (Water)	:	Autopump / Technika / Techtrol / Pumptrol
65.	GRP / FRP tanks	:	Sintex / Thermoset / Binani / Devi Polymers / Smartage
66.	Liquid Level Controllers	:	Honeywell / Johnson Control
67.	Pipe protection tape Concealed /Buried	:	Tapex / Pipe Coat
68.	Concealed Cistern	:	Gebrit
69.	CI LA Class pipe & fittings	:	Electrosteel / Neco
70.	Toilet Accessories	:	Kohler / Bob Rick
71.	Urinal flushing sensor	:	TOTO
72.	Kitchen Sink	:	Frankee / Jayna
73.	Soap Dispenser	:	Bob rick
74.	Hand Dryer	:	Bob rick
75.	Rain Water collection kurra	:	Neer
76.	Water hammer arrester	:	CPP / Zurn W ilkins

77.	RCC Hume pipes	:	Indian Hume Pipes
78.	Sch -80 pipes and fittings	:	Astral / Ajay / Ashirvad
79.	PPR pipe and fittings	:	Supreme / Prince
80.	Grease / Oil Separator	:	ACO

SPEC.NO.

TCE.10477A-PP-  
6041-60540

**TATA CONSULTING ENGINEERS LIMITED**

**LIST OF VENDORS**

SECTION: F4

SHEET 1 OF 4

**FIRE FIGHTING WORKS- APPROVED MAKE**

ISSUE  
P0

**1.0 GENERAL**

This section provides details of the Approved Vendors / Approved makes for bought-out items, which form a part of this enquiry package.

BIDDER shall clearly indicate the makes of all bought-out items and shall at no point in time during execution shall deviate from those indicated in the offer document.

**2.0 LIST OF APPROVED VENDORS / MAKES -**

SN	Item	Bosch
1	GI pipe + Fittings	Jindal, or equivalent
2	Ball Valve =<50mm	KSB, or equivalent
2a	Ball Valve >50mm (UL/FM Approved)	Victaulic, or equivalent
3	GM Non-Return Valve =<50mm	KSB, or equivalent
3a	GM Non-Return Valve >50mm (UL/FM Approved)	Victaulic, or equivalent
4	Pressure Gauge	WIKA, or equivalent
5	Butter Fly Valve=<50mm	KSB, or equivalent
5a	Butter Fly Valve >50mm (UL/FM Approved)	Victaulic, or equivalent
6	Fire Fighting Pump (UL Listed)	KSB, or equivalent
7	Electrical Motor (UL Listed)	Siemens, ABB, or equivalent (As per Pump OEM)
8	Diesel Engine (UL/FM Listed)	KSB, or equivalent
9	Fire Fighting Accessories	Minimax, or equivalent
10	Portable Fire Extinguisher	Minimax, or equivalent
11	Sprinkler Bulb / Sprinkler Heads (UL/FM Listed)	Tyco, Viking, or equivalent
12	Cable	Laab, Finolex, or equivalent
13	R.R.L Hose	Minimax, or equivalent



14	Hydrant Valve =<50mm	Minimax, or equivalent
14a	Hydrant Valve >50mm (UL/FM Approved)	Minimax, or equivalent
15	Air Release valve	Flamco, or equivalent
16	Y-Strainer =<50mm (UL/FM Approved)	KSB, or equivalent
16a	Y-Strainer >50mm	Victaulic, or equivalent
17	Pressure Switch	Viking, or equivalent
18	Sprinkler Alarm Valve / Installation Control Valve (UL/FM Listed)	Viking, or equivalent
19	Hose Reel Drum	Minimax, or equivalent
20	Pipe wrapping/coating tape	IWL, Pypko, or equivalent
21	Flow Meter	Belimo, or equivalent
22	Fire Hose	Minimax, or equivalent
23	Hose Coupling	Minimax, or equivalent
24	Hose Cabinet	Minimax, or equivalent
25	Flow Switch	Viking, or equivalent
26	Sluice Valve / Gate Valve =<50mm	KSB, or equivalent
26a	Sluice Valve / Gate Valve >50mm	Victaulic, or equivalent
27	NRV / Check Valve =<50mm	KSB, or equivalent
27a	NRV / Check Valve >50mm (UL/FM Approved)	Victaulic, or equivalent Tyco
28	Signages	Autoglo, Gloite, or equivalent
29	Motor Control Centre	Pragati Control, or equivalent
30	Cable Tray	Profab, or equivalent
31	Flexible Pipe (UL Listed)	Viking, Minimax, or equivalent

SPEC.NO.

**TATA CONSULTING ENGINEERS LIMITED**

SECTION: F4

TCE.10477A-PP-  
6041-60540**LIST OF VENDORS**

SHEET 4 OF 4

32	Annunciation Panel	Minimax, or equivalent
33	Grooved Coupling (UL/FM)	Victaulic, or equivalent
34	Pipe Support	Müpro, or equivalent
35	Anchor Fastener / Clamps / pipe hangers/Support	Mupro, Hilti , Fisher, OM, Powers, Hi-Tech, Nipro, Easy Flex
36	Welding Rods	Ador,Cosmos,Esab,Super Bond(S)
37	Structural steel	Tata, Jindal Hissar
38	Foot valve with strainer	Kirloskar/Normex/Tyco/Zoloto
39	Air vessel	Nema / Zenith
40	Flow Test Meter	Viking, Globe Vision/Jerrad/ Eureka forbes
41	Fire brigade connection	Newage (Mumbai), Newage (Surendranagar), Eversafe, Safeguard, Shah Bhogilal
42	Zone/Floor Control Valve	Reliable/Tyco/Viking/HD Fire
43	Sprinkler flexible pipe	HD Fire, Tyco, Safex/New age
44	Power cables	Finolex, Universal, Polycab,RR
45	Control cables - armoured/ unarmoured, FRLS	Finolex, Universal, Polycab,RR
46	Paint, Primer	Asian Paint, Nerolac , Berger,
47	Anti-Vibrating Mounting pads/ Expansion Joints	Dulop, Resistoflex , Easy flex,

ISSUE  
P0

APPROVED MAKE LIST- IBMS SYSTEM

S. No.	MAJOR COMPONENTS	SUB COMPONENTS - DESCRIPTION	MANUFACTURER'S NAME
1	FIRE ALARM & PA SYSTEM	Addressable Smoke / Heat / Optical Detectors/ Hooters / Hooter Cum Strobe (UL & FM Approved) / Fault Isolator	Siemens ,Notifier,Simplex, Bosch
2	FIRE ALARM & PA SYSTEM	Control Relay module	Siemens ,Notifier,Simplex, Bosch
3	FIRE ALARM & PA SYSTEM	MCP	Siemens ,Notifier,Simplex, Bosch
4	FIRE ALARM & PA SYSTEM	Beam Detector	System Sensor , GST
5	FIRE ALARM & PA SYSTEM	Monitor Module, Interface module	Siemens ,Notifier,Simplex, Bosch
6	FIRE ALARM & PA SYSTEM	Response Indicator	Ravel , Stanley
7	FIRE ALARM & PA SYSTEM	Addressable Fire Alarm panel / Repeater Panel	Siemens ,Notifier,Simplex, Bosch
8	FIRE ALARM & PA SYSTEM	PC Interface	HP , Dell
9	FIRE ALARM & PA SYSTEM	Graphic Software	Siemens ,Notifier,Simplex, Bosch
10	FIRE ALARM & PA SYSTEM	Amplifier / Digital PA Controller / Digital Call Stations	Stanley , Honeywell , Bosch
11	FIRE ALARM & PA SYSTEM	PA Panel	Honeywell , Bosch , Ravel , Stanley , Ateis
12	FIRE ALARM & PA SYSTEM	Talk Back / Speakers	Honeywell , Bosch , Ravel , Stanley
13	FIRE ALARM & PA SYSTEM	P.V.C. Insulated Copper Conductor wires	Finolex , Polycab , Skytone
14	FIRE ALARM & PA SYSTEM	Control Cables	Finolex , Polycab , Skytone
15	FIRE ALARM & PA SYSTEM	Fire Survival Cables	Tyco , Delton , FrTek , AFW
16	FIRE ALARM & PA SYSTEM	MS Conduit and accessories	B.E.C. , AKG
17	FIRE ALARM & PA SYSTEM	PVC Conduit and accessories	AKG , BEC
18	FIRE ALARM & PA SYSTEM	Battery	Exide , Standard , Amco , Prestolite
19	FIRE ALARM & PA SYSTEM	PA system / Speakers	Bosch,Stanley,Ravel
20	FIRE ALARM & PA SYSTEM	Exit Sign	Glow light , Legrand , Autoglow , Pierlite , Honeywell,Stanley
21	FIRE ALARM & PA SYSTEM	Any Other Itmes	On Approval of Consultant or Engineer-In-Charge
22	FIRE ALARM & PA SYSTEM	Fire Fighter Telephone JACK /TALK Back System	Ravel, GST ,System Sensor ,Stanley
23	CCTV SYSTEM	Dome Camera	Honeywell, Bosch, Pelco, Axis
24	CCTV SYSTEM	Bullet Camera	Honeywell, Bosch, Pelco, Axis
25	CCTV SYSTEM	PTZ Camera	Honeywell, Bosch, Pelco, Axis
26	CCTV SYSTEM	NVR	Honeywell, Bosch, Pelco, Axis
27	CCTV SYSTEM	DVR	Honeywell, Bosch, Pelco, Axis
28	CCTV SYSTEM	Surveillance Grade HDD	Seagate, WD
29	CCTV SYSTEM	Work station (PC)	Dell, HP
30	CCTV SYSTEM	Professional LED Television	Samsung, LG
31	CCTV SYSTEM	CAT-6 IO with Box and Face Plate	D-Link, Molex, Systimax
32	CCTV SYSTEM	Pre- Fab 2 Mtrs. Long CAT-6 Cable	D-Link, Molex, Systimax
33	CCTV SYSTEM	Patch Panel	D-Link, Molex, Systimax
34	CCTV SYSTEM	Network Rack	Vallrack, Dlink
35	CCTV SYSTEM	Ethernet Switch (24/28/32 Port Layer-2/3)	D-Link, Molex, Systimax
36	CCTV SYSTEM	CAT-6 Cable	AMP , Systemax , Lucent , Legrand
37	CCTV SYSTEM	Unarmored Flexible copper cable	Universal (Satna) , CCI , Nicco , Finolex , Polycab , Skytone , RR
38	CCTV SYSTEM	Power Supply	Reputed
39	CCTV SYSTEM	Conduits and accessories	AKG , BEC , Finolex , ATUL
40	ACCESS CONTROL SYSTEM	EM Lock	BEL, Belco
41	ACCESS CONTROL SYSTEM	Door Magnetic Contact	Reputed
42	ACCESS CONTROL SYSTEM	Micro-processor based Access Control Reader Module	Honeywell, HID, Lenel
43	ACCESS CONTROL SYSTEM	Access Control Input / Output Module	Honeywell, Bosch, Pelco, Axis
44	ACCESS CONTROL SYSTEM	Push Button	Honeywell, HID, Lenel
45	ACCESS CONTROL SYSTEM	Dual Emergency Break Glass Unit	Honeywell, HID, Lenel
46	ACCESS CONTROL SYSTEM	Micro-processor based Access Control Master Controller	Honeywell, HID, Lenel
47	ACCESS CONTROL SYSTEM	Access Control Software	Honeywell, HID, Lenel
48	ACCESS CONTROL SYSTEM	SMPS 240 VAC- 12 VDC 5 Amp.	Reputed
49	ACCESS CONTROL SYSTEM	Smart Card Reader	HID
50	ACCESS CONTROL SYSTEM	Buzzer 12VDC	Honeywell, HID, Lenel
51	ACCESS CONTROL SYSTEM	CAT-6 Cable	AMP , Systemax , Lucent , Legrand
52	ACCESS CONTROL SYSTEM	Network Rack	Vallrack, Dlink
53	ACCESS CONTROL SYSTEM	Unarmored Flexible copper cable	Polycab, Havells, Skytone
54	ACCESS CONTROL SYSTEM	16 Port Layer-2 Semi Managed Switch	Dlink, Molex, Systimax
55	ACCESS CONTROL SYSTEM	Conduits and accessories	AKG , BEC , Finolex , ATUL

S. No		ITEMS	MAKES
1	I-BMS	CENTRAL CONTROL STATION	Lenovo / IBM / HP / DELL
2	I-BMS	BUILDING MANAGEMENT SYSTEM WEB-BASED SERVER SOFTWARE	Honeywell (Comfort Point)/ Johnson Controls Metasys / ALC / L&T
4	I-BMS	PROGRAMMABLE & APPLICATION SPECIFIC CONTROLLER (DDC)	Honeywell (Comfort Point)/ Johnson Controls Metasys / ALC / L&T
4	I-BMS	WEB SERVER ENGINES (NETWORK / SUPERVISORY CONTROLLERS)	Honeywell (Comfort Point)/ Johnson Controls Metasys / ALC / L&T
5	I-BMS	INTEGRATORS	Honeywell (Comfort Point)/ Johnson Controls Metasys / ALC / L&T
<b>6</b>		<b>SENSORS AND FIELD DEVICES</b>	
a	I-BMS	Immersion type temperature sensors	Honeywell/Johnson Controls/L&T/ALC
b	I-BMS	Differential Pressure Switch (blowers & Filters & Pump)	Honeywell/Johnson Controls/L&T/ALC
c	I-BMS	Duct mount temperature & RH sensor	Honeywell/Johnson Controls/L&T/ALC
d	I-BMS	Damper Actuator	Honeywell/Johnson Controls/L&T/ALC I
e	I-BMS	CO Sensor	JohnsonControls/Honeywell/Greystone/GE/ MSR(Germany)/ Dwyer/Omicron
f	I-BMS	CO2 Sensor	Johnson Controls//Honeywell/ MSR(Germany)/ Dwyer

g	I-BMS	Current Relay	Johnson Controls/Honeywell/Kele/ Sentry
h	I-BMS	Water level Switch / Transmitter	Johnson Controls/ Sanitech / Honeywell/ Filpro/ Sontay/ Veksler
i	I-BMS	Water Pressure Sensor	Johnson Controls/Omnicon /Honeywell/Kele
j	I-BMS	Outside Air Temperature/ RH Sensor	Honeywell/ Invensys/ Johnson Controls / Dwyer
<b>7</b>		<b>WIRING &amp; CONDUITING</b>	
a	I-BMS	Communication Cables / Signal Cable/ Control Cable	Teleflex / Skytone/Polycab/Fusion Polymer/ Excel / Bonton
b	I-BMS	MS/GI/ PVC conduits	BEC / AKG/ Precision / NIC / Steelcraft
c	I-BMS	CAT 6 cable	Leviton/ Amp / Panduit/ Systimax

**SCHEDULE E**  
**SURVEY & INVESTIGATION REPORTS**

ANNEXURE-1 - GEOTECHNICAL INVESTIGATION REPORT

A REPORT ON  
GEO-TECHNICAL INVESTIGATION WORK  
FOR  
**CONSTRUCTION**  
OF  
**COMMAND AND CONTROL BUILDING, PANJABARI**

REPORT PREPARED AND INVESTIGATED BY :



**GEO TECHNO CONSULTING SOLUTIONS**

H-11, SHIVASTHAN PATH, KHANAPARA  
GUWAHATI-781022  
MOBILE NO.: 9678839793

SUBMITTED BY:

**M/S RAJKHOWAS AARCHI,  
CHANDMARI, GUWAHATI**

## **1. INTRODUCTION:**

**1.1** This report presented herein deals with the field and laboratory investigations carried out by us to access the nature of sub-strata and to evaluate the soil parameters required for design of foundations proposed to be constructed for proposed building.

**1.2** Client's help is gratefully acknowledged in providing bore hole locations, close supervision and checking during boring, sampling, various testing operations and cooperation and guidance during finalization of report.

**1.3** The work of Geotechnical Investigation was awarded to M/S RajkhowasAarchi, M.D. Road, Chandmari, Guwahati-781003.

**1.4** This report is based upon the results of field, laboratory tests conducted on selected soil/rock samples collected from five bore holes up to the depth of 39 m respectively and interpretation of results were done as per IRC 78-2000 and pertinent IS code of practices.

## **2. SCOPE OF WORK:**

The scope of work provided to us for this project was limited to the following: -

**2.1** Mobilizing necessary plant, equipment and personnel to the project site, setting up the equipment, carrying out the field investigations on land and demobilization on completion of work.

**2.2** Making 150 mm nominal diameter bore holes at the site in all types of soil using suitable approved method of boring to be given at site by the Engineer-in-Charge. Refusal shall mean when SPT field 'N' value reaches 50 for 30 cm or less penetration of SPT sampler.

**2.2.1** Conducting standard penetration tests in the bore holes at 1.50 m interval in depth as per specifications / instructions of Engineer-in-Charge.

**2.2.2** Collecting undisturbed soil samples from bore holes at 3.0m interval or every change of strata, whichever is earlier as per specifications.

**2.2.3** Collecting disturbed soil samples from bore hole at regular interval and at every identifiable change of strata to supplement the boring records.

**2.2.4** Recording the depth of ground water table in all the bore hole if observed up to the depth of exploration during boring work as per specifications & withdrawing the casing pipe.

**2.3** Conducting the following laboratory tests on selected disturbed / undisturbed soil samples collected from bore hole / test locations: -

(a) Bulk density and Moisture content

(b) Sieve analysis

(c) Hydrometer analysis

(d) Liquid limit & Plastic limits

(e) Specific gravity

(f) Shear test on undisturbed and remoulded saturated disturbed soil samples

(g) Determination of void ratio.

2.4 Preparation and submission of report in three copies.

### **3.0 FIELD INVESTIGATIONS:**

3.1 Necessary plant, equipment and personnel for conducting the requisite field work were mobilized to the site.

3.2 Five numbers of boreholes were first marked on the ground surface as per the layout given to us by the Engineer-in-Charge.

3.3 Bore hole was bored at this site using rotary drilling method as per IS: 1892-1979.

3.3.1 Standard penetration tests were conducted in the above bore hole at every 1.50 m interval & at change of strata as per specifications / instructions of Engineer-in-Charge. The bore was cleaned up to the desired depths. Standard split spoon sampler attached to lower end of 'A' drill rods was driven in the bore holes by means of standard hammer of 63.5 Kg. falling freely from a height of 75 cm. The sampler was driven 45 cm as per specifications & the numbers of blows required for each 15 cm penetration were recorded. The numbers of blows for the first 15 cm penetration were not taken into account. This was considered as seating drive. The numbers of blows for next 30 cm penetration were designated as SPT 'N' value. Wherever the total penetration was less than 45 cm, the number of blows & the depth penetrated is incorporated in respective bore logs. Disturbed soil samples obtained from standard split spoon sampler for all the above standard penetration tests were collected in polythene bags of suitable size. These samples were properly sealed, labelled, recorded and carefully transported to the laboratory for testing.

3.3.2 Undisturbed soil samples were collected from the bore hole at every 3.00 m interval in depth & at change of strata as per sampling specifications. These sampling tubes after retrieval from the bore hole was properly waxed and sealed at both ends. These were carefully labelled and transported to the laboratory for testing. Undisturbed soil samples wherever slipped during lifting, were duly marked in the field bore logs as well as in the soil profile.

3.3.3 Disturbed soil samples were also collected from the bore hole at suitable depths/intervals to supplement the boring records. These samples were collected in polythene bags of suitable size. These samples were properly sealed, labelled, recorded & carefully transported to the laboratory for testing.

3.3.4 The depth of ground water table was checked / measured in all bore holes.

### **4.0 LABORATORY INVESTIGATIONS:**

4.1 The following laboratory tests were conducted on selected soil samples recovered from bore hole / test locations: -

- (a) Bulk density and Moisture content
- (b) Sieve analysis
- (c) Hydrometer analysis
- (d) Liquid limit & Plastic limits
- (e) Specific gravity
- (f) Shear test on remoulded and saturated disturbed soil samples
- (g) Determination of void ratio.



All the above laboratory tests were carried out as per relevant Indian Standards. All the soil samples were identified and classified as per IS: 1498-1970.

### 5.0 FINDING OF GEOTECHNICAL INVESTIGATION:

The study of bore logs/results of laboratory and other field tests are tabulated through different tables as annexure.

Analysis of liquefaction potential It is analysed through Seed and Idriss (1982) approach Liquefaction is generally occurs in fine to medium sand within a depth of 10.0M from ground surface. With increasing overburden pressure, the chances of liquefaction usually decrease. (Cl 13.5.1, Theory and practice of Foundation design NN Som, S.C. Das, Prentice hall of India Pvt Ltd Publisher).

### 6.0 CALCULATION OF BEARING CAPACITY

#### (A) Calculation of Net Safe Bearing Capacity based on shear Criteria

IS: 6403-1981 recommends the following equation to calculate the net Safe Bearing Capacity 'Qs' based on Hansen's Bearing Capacity analysis:

$$Q_s = 1/F \{ C N_c S_c d_c i_c + q (N_q - 1) S_q d_q i_q + 0.5 \gamma B N \gamma S \gamma d \gamma i \gamma x R_w \}$$

Where, C = Cohesion of soil.

$\gamma$  = Saturated Density of soil

B = Width of footing

$R_w$  = Water table correction factor depending upon position of water table with respect to founding level

Q = Effective surcharge at footing level =  $\gamma D$  (D = depth of footing)

$N_c, N_q, N \gamma$  = Bearing capacity factor

$S_c, S_q, S \gamma$  = Shape factor

$d_c, d_q, d \gamma$  = depth factor

$i_c, i_q, i \gamma$  = inclination factors

F = Factor of safety = 3.0

### SAFE LOAD CAPACITY FOR BORED CAST IN-SITUREINFORCED CONCRETEPILE

This section provides the Safe Load Carrying Capacity of few piles of predetermined diameter and length. For calculating the Safe Load Carrying Capacity, design philosophy as suggested by IS: 2911 (Part I) -1979 is followed. The Ultimate Load Capacity of each pile is determined using Static Pile Load Formulae considering shear criteria. The Ultimate Load Capacity is calculated as,

$$Q_u = Q_b + Q_f$$

Where,

$Q_b$  = Load carried by Point Bearing =  $q_{pu} A_b$

$Q_f$  = Load carried by Skin Friction =  $f_s A_s$

Again,

$$Q_u = q_{pu} A_b + f_s A_s$$

Where,

$q_{pu}$  = Unit End Bearing Resistance

$A_b$  = Sectional area of the pile at its base

$f_s$  = Unit Skin Friction Resistance of a particular layer

$A_s$  = Surface Area of the pile in contact with the particular soil layer

Safe Load Capacity,

$$Q_s = Q_u / \text{F.O.S.}$$

F.O.S. = Factor of Safety = 2.5

The Ultimate Pullout Resistance is calculated as,

$$Q_{ut} = f_s A_s + W_p,$$

Where,

$W_p$  = Weight of the pile Safe Load Capacity,

Again,  $Q_{st} = Q_{ut} / \text{F.o.S.}$

F.o.S. = Factor of Safety = 3.

### **B) Calculation of safe bearing pressure based on tolerable settlement.**

The safe bearing pressure is to be found out from the elastic settlement consideration and is found from the following equation given I.S. 8009 (part 1) 1976

$$S_f = S_{oed} = \frac{H_t}{1+e_o} C_c \log_{10} (p_o + \Delta p) / p_o$$

$S_f$  = Final settlement in mm

$S_{oed}$  = Settlement computed from one dimensional test

$H_t$  = Thickness of soil layer in m

$e_o$  = Initial void ratio at mid height of of layer

$C_c$  = Compression Index

$p_o$  = Initial effective pressure at mid height of layer

$\Delta p$  = pressure increment

For the computation of settlement of foundation founded at certain depth, a correction should be applied to the calculated  $S_f$  in the form of a depth factor to be read from Fig: 12 of I.S. 8009 (part 1) 1976.

Corrected settlement  $S_{fd} = S_f \times \text{depth factor}$

Depth factor is dependent on the following: -

i.  $D$  = Depth of footing ii.  $L$  = Length of footing iii.  $B$  = Width of footing

### **B) Calculation of safe bearing pressure based on tolerable settlement.**

The safe bearing pressure is to be found out from the elastic settlement consideration and is found from the following equation given I.S. 8009 (part 1) 1976

$$S_f = S_{oed} = \frac{H_t}{1+e_o} C_c \log_{10} (p_o + \Delta p) / p_o$$

$S_f$  = Final settlement in mm

$S_{oed}$  = Settlement computed from one dimensional test

$H_t$  = Thickness of soil layer in m

$e_o$  = Initial void ratio at mid height of of layer

$C_c$  = Compression Index

$p_o$  = Initial effective pressure at mid height of layer

$\Delta p$  = pressure increment

For the computation of settlement of foundation founded at certain depth, a correction should be applied to the calculated  $S_f$  in the form of a depth factor to be read from Fig: 12 of I.S. 8009 (part 1) 1976.

Corrected settlement  $S_{fd} = S_f \times \text{depth factor}$

Depth factor is dependent on the following: -

- i. D= Depth of footing ii. L= Length of footing iii. B= Width of footing

### 7.0 Site Photographs:



















### 8.0 LABORATORY AND FIELD TEST RESULT



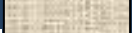

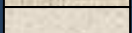





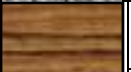





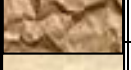

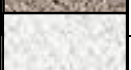

#### (i) Standard Penetration Test

Table 1: Standard penetration test result (BH-1)



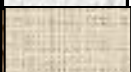

Standard Penetration Test conforming to IS 2131-1981				Bore Hole: 1				
Name of project: RCC building at Puran Basti, Sixmile				Start Date :27/10/19 End Date: 29/10/19				
Method: Hand and wash Boring				Ground water level: 1.0 m				
Description	Depth	Strata	Sample Type	SPT				Corrected N value
				15cm	15cm	15cm	N value	

GL to 1.0 m Brownish sandy clay 13.5 m to 16.0m Brownish gray silty sand 16 m to 22.50 m Brownish sandy clay 23.0 m to 32.0 m Brownish clayey soil. 32.0 m to 34 m Brownish gray sandy clay. 34 m to 39 m brownish fine sand.	13.5		DS	4	5	6	11	
	15		DS	4	4	4	8	13
	16.5		DS	4	5	7	12	16
	18		DS	4	5	8	13	16
	19.5		DS	5	6	7	13	15
	21		DS	6	7	9	16	16
	22.5		DS	6	10	8	18	17
	24		DS	6	9	12	21	18
	25.5		DS	7	9	13	22	18
	27		DS	6	8	11	19	16
	28.5		DS	7	8	10	18	15
	30		DS	7	9	12	22	16
	31.5		DS	8	9	11	20	15
	33		DS	7	10	12	22	16
	34.5		DS	8	9	13	22	16
	36		DS	8	10	12	22	15
37.5		DS	8	10	14	24	16	
39		DS	9	11	14	25	28	





**Table.2: Standard penetration test result (BH-2)**

Standard Penetration Test conforming to IS 2131-1981				Bore Hole: 2				
Name of project: RCC building at Puran Basti, Sixmile				Start Date :29/10/19 End Date:30/10/19				
				Ground water level:0.7 m				
Description	Depth	Strata	Sample Type	SPT				Corrected N value
				15cm	15cm	15cm	N value	
GL 0.0 to 2.5 m Brownish Sandy clay	9			7	9	12	21	25
	10.5		DS	8	9	13	22	23
9m to 11 m Brownish sandy clay	12		DS	10	13	14	27	25
	13.5		DS	9	12	15	27	23
11 m to 13 m Sandy clay	15		DS	13	21	27	48	34
	16.5		DS	5	7	9	16	16
13 m to 18 m Brownish clay	18		DS	6	8	9	17	16
	19.5		DS	7	8	10	18	16
18m to 21.0 m silt	21		DS	11	14	19	33	22
	22.5		DS	8	11	16	27	19
21.0 m to 26 m Grey silt	24		DS	8	9	11	20	16
	25.5		DS	8	10	13	23	17
26 m to 35 m Grayish clay with silty form	27		DS	7	8	9	17	13
	28.5		DS	7	9	11	20	15
35.0 m to 39.0 m Brownish clay soil form	30		DS	8	10	10	20	14
	31.5		DS	8	9	10	19	13
	33		DS	7	9	12	21	25
	34.5		DS	8	10	14	24	27
	36		DS	10	12	15	27	29
	37.5		DS	9	10	14	24	26
	39		DS	10	13	18	31	33

**Table 3: Standard penetration test result (BH-3)**

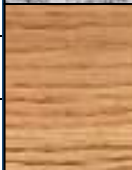
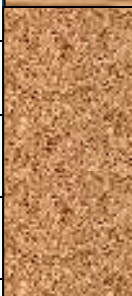
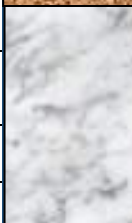

Standard Penetration Test conforming to IS 2131-1981				Bore Hole: 3				
Name of project: RCC building at Puran Basti, Sixmile				Start Date :30/10/19				
				End Date: 1/11/19				
				Ground water level: 1.0 m				
Description	Depth	Strata	Sample Type	SPT				Corrected N value
				15cm	15cm	15cm	N value	
	9			8	9	10	19	23
GL to 1.20 m Brownish sandy clay	10.5		DS	6	7	8	15	18
9 m to 10m	12		DS	5	7	8	15	17
Brownish silty sand	13.5		DS	5	6	8	14	16
10.50 m to 16 m Brownish gray silty sand	15		DS	7	8	8	16	16
16 m to 18.50 m Grayish sandy clay	16.5		DS	5	6	8	14	14
	18		DS	6	8	9	17	16
18.50 m to 25 m grayish Silty clay	19.5		DS	8	10	12	22	18
	21		DS	10	12	15	27	20
25 m to 39 m grayish clay	22.5		DS	11	14	16	30	20
	24		DS	22	27	36	63	33
	25.5		DS	16	24	30	54	29
	27		DS	10	10	12	22	16
	28.5		DS	9	10	11	21	15
	30		DS	8	9	11	20	14
	31.5		DS	7	9	10	19	13
	33		DS	9	11	13	24	28
	34.5		DS	10	11	15	26	28
	36		DS	8	10	13	23	26
	37.5		DS	11	14	15	29	30
	39		DS	11	14	17	31	33

**Table 4: Standard penetration test result (BH-4)**

Standard Penetration Test conforming to IS 2131-1981				Bore Hole: 4				
Name of project: RCC building at Puran Basti, Sixmile				Start Date :1/11/19				
				End Date: 1/11/19				
				Ground water level: 1.0 m				
Description	Depth	Strata	Sample Type	SPT				Corrected N value
				15cm	15cm	15cm	N value	
	9							
	10.5		DS	3	3	4	7	11
	12		DS	8	12	12	24	24
	13.5		DS	3	4	5	9	12
	15		DS		6		13	15
	16.5		DS	7	8	10	18	17
9.0 m to 16.0 m grayish fine sand.	18		DS	16	18	20	38	27
	19.5		DS	11	11	13	24	19
16.0 m to 21 m Brownish clay with silty form	21		DS	10	12	13	25	19
	22.5		DS	12	12	14	26	19
21 m to 22m Grayish fine sandy soil	24		DS	25	26	28	54	30
	25.5		DS	11	15	15	30	20
22 to 28.0 m Brownish clay	27		DS	8	12	16	28	19
	28.5		DS	10	15	17	32	20
28.0 m to 34 m Brownish sandy clay soil	30		DS	13	20	22	42	23
	31.5		DS	11	18	25	43	23
34 m to 39m greyish clayey soil	33		DS	16	24	24	48	24
	34.5		DS	15	21	29	50	49
	36		DS	18	22	27	49	47
	37.5		DS	14	23	30	53	49
	39		DS	16	27	17	44	42



**Table 5: Standard penetration test result (BH-5)**

Standard Penetration Test conforming to IS 2131-1981				Bore Hole: 5				
Name of project: RCC building at Puran Basti, Sixmile				Start Date :3/11/19 End Date: 5/11/19				
				Ground water level: 0.7 m				
Description	Depth	Strata	Sample Type	SPT				Corrected N value
				15cm	15cm	15cm	N value	
	9							
	10.5		DS	3	6	3	9	15
	12		DS	5	5	7	12	16
	13.5		DS	3	4	12	16	18
	15		DS	12	23	30	53	39
	16.5		DS	8	11	12	23	20
	18		DS	10	13	13	26	21
9.0 m to 19.5 m grayish fine sand.	19.5		DS	15	15	20	35	24
19.5 m to 21 m Brownish sand								
21.10m to 28m greyish sandy clay	21	DS	19	23	28	51	31	
	22.5		DS	13	15	16	31	21
	24		DS	10	12	14	26	18
	25.5		DS	8	12	12	24	17
	27		DS	24	24	30	54	29
28 m to 39m Grayish clay	30		DS	18		22	43	24
	31.5		DS	23	25	28	53	27
	33		DS	30	31	33	64	30
	34.5		DS	25	30	35	65	30
	36	DS	29	33	40	73	69	
	37.5	DS	26	28	38	66	60	

(ii) Particle size analysis

Table 6: Grain size distribution corresponding to BH- 1

Depth (m)	Percentage smaller than					Soil Group
	19	4.75	2	0.425	0.075	
	(mm)					
15	100	100	100	100	28.67	CI
16.5	100	100	100	100	25.2	SP
18	100	100	100	100	91.2	CI
19.5	100	100	100	100	94.3	CI
21	100	100	100	100	92.3	CI
22.5	100	100	100	100	4.2	SP
24	100	100	100	100	6.3	SW-SM
25.5	100	100	100	100	4.3	SP
27	100	100	100	100	2.2	SP
28.5	100	100	100	100	96.5	CI
30	100	100	100	100	95.6	CI
31.5	100	100	100	100	96.7	CI
33	100	100	100	100	97.1	CI
34.5	100	100	100	100	95.2	CI
36	100	100	100	100	96.3	CI
37.5	100	100	100	100	97.4	CI
39	100	100	100	100	90.6	CI

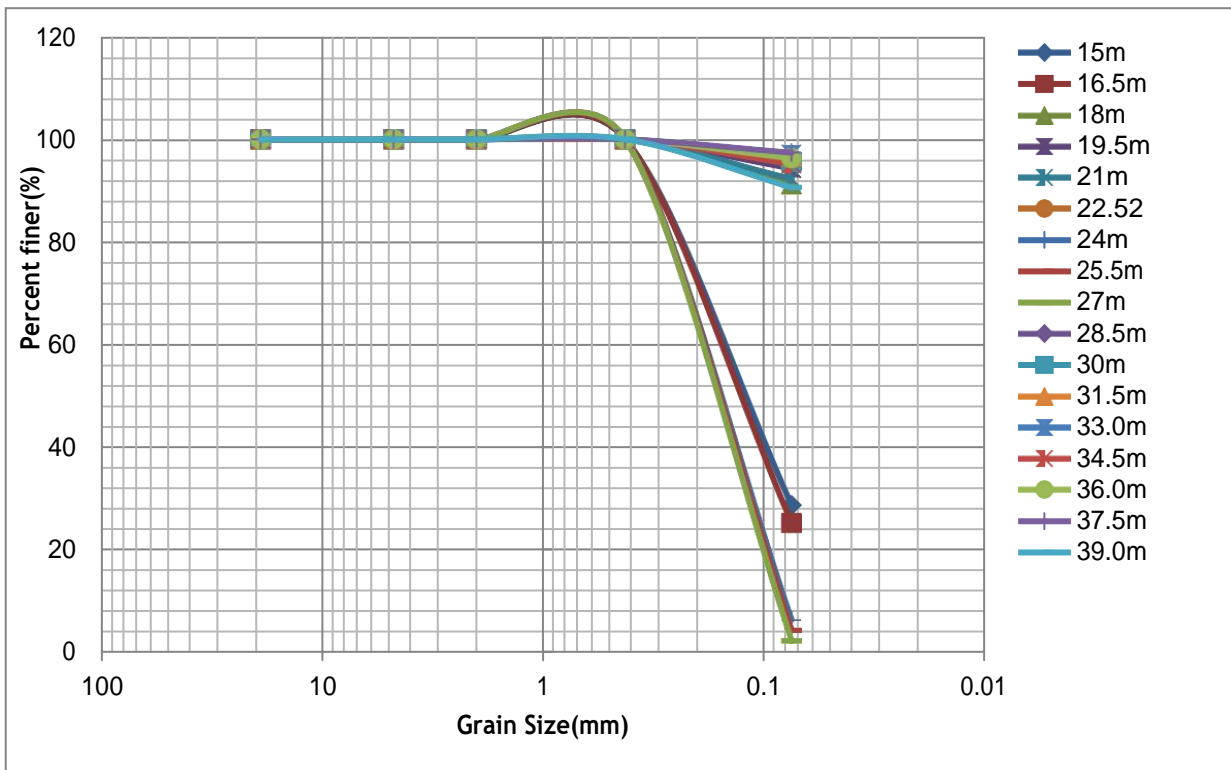

Table 7: Grain size distribution corresponding to BH- 2

Depth (m)	Percentage smaller than					Soil Group
	19	4.75	2	0.425	0.075	
	(mm)					
16.5	100	100	100	100	94.7	CI
18	100	100	100	100	94.3	CI
19.5	100	100	100	100	96.6	CI
21	100	100	100	100	98.2	CI
22.5	100	100	100	100	7.3	SW-SM
24	100	100	100	100	5.8	SW-SM
25.5	100	100	100	100	4.3	SP
27	100	100	100	100	3.5	SP
28.5	100	100	100	100	2.3	SP
30	100	100	100	100	2.6	SP
31.5	100	100	100	100	7.1	SW-SM
33	100	100	100	100	94.8	CI
34.5	100	100	100	100	95.1	CI
36	100	100	100	100	97.2	CI
37.5	100	100	100	100	90.6	CI
39	100	100	100	100	86	CI

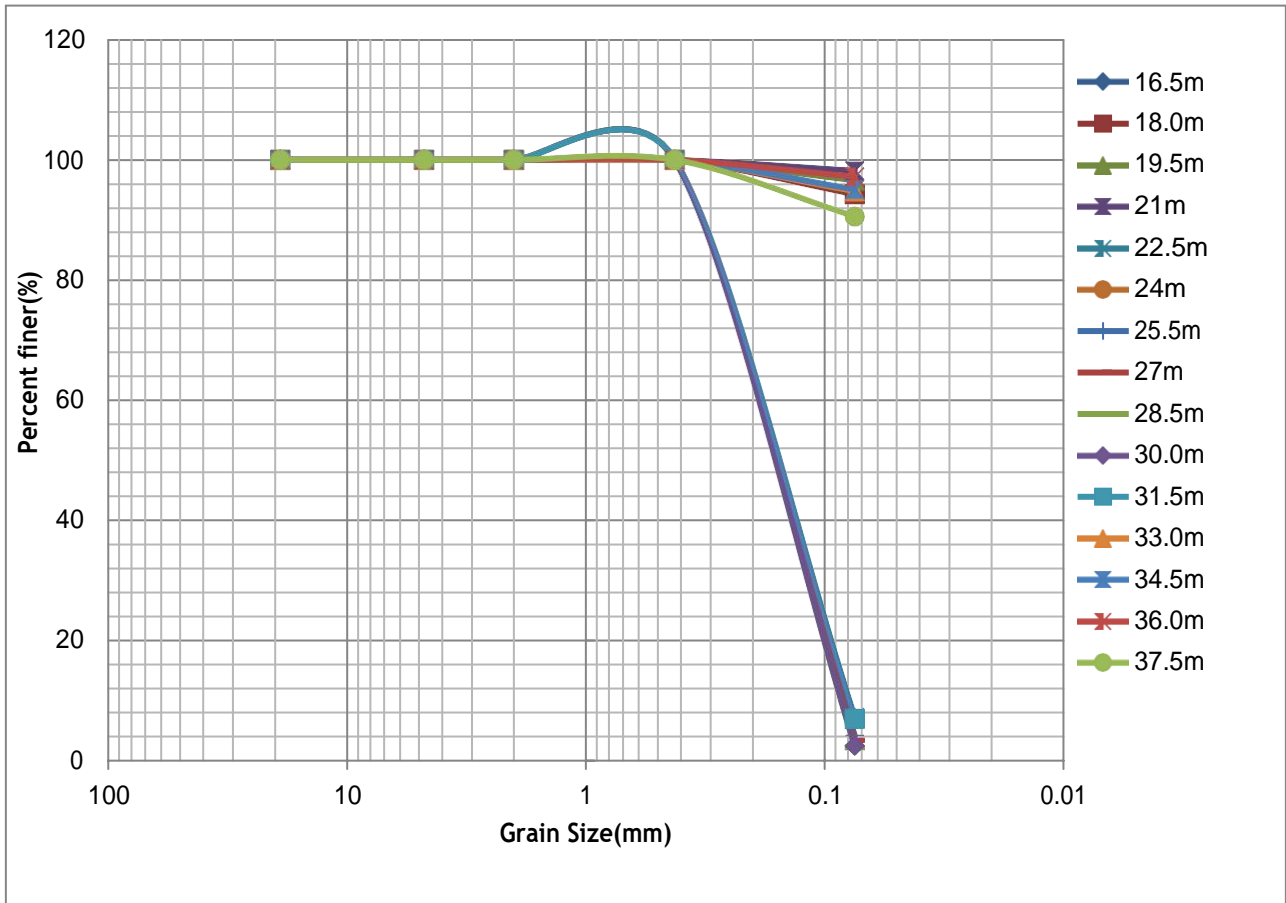
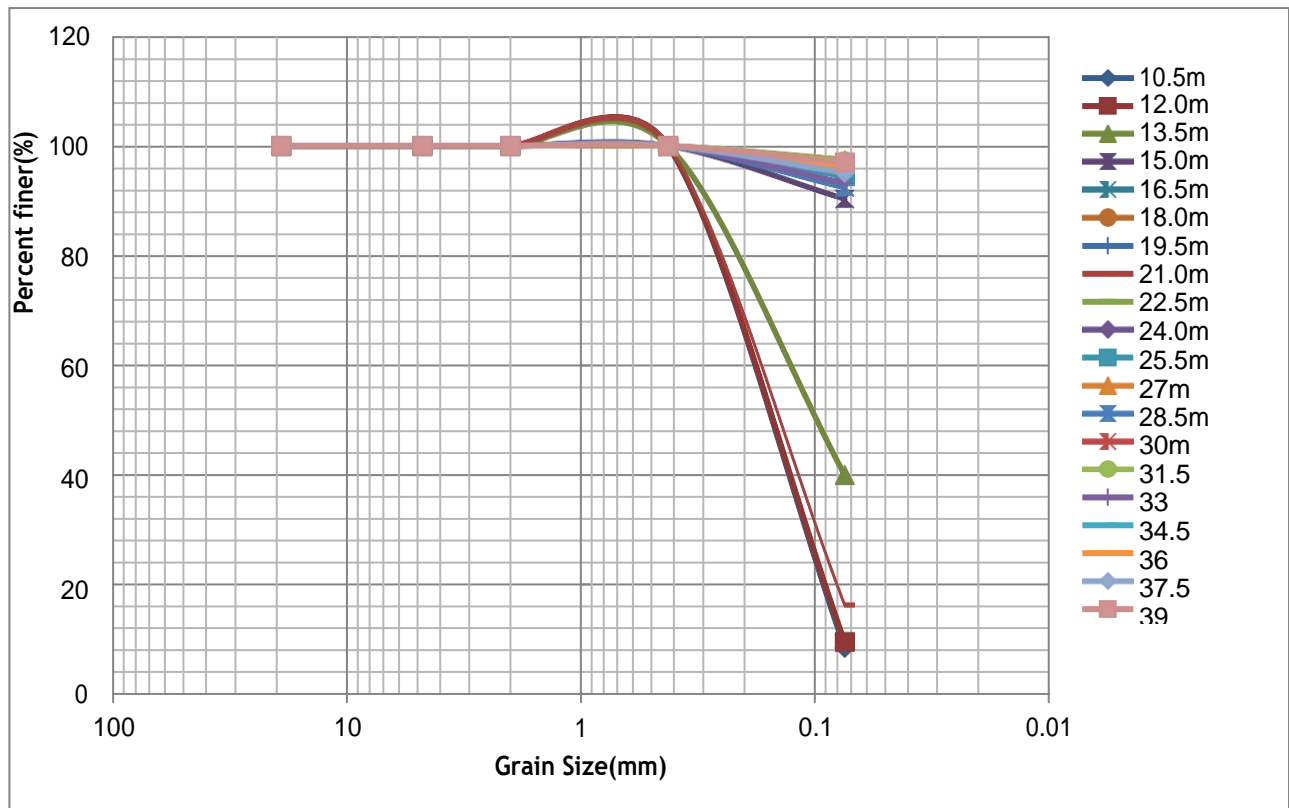

Table 8: Grain size distribution corresponding to BH- 3

Depth (m)	Percentage smaller than					Soil Group
	19	4.75	2	0.425	0.075	
	(mm)					
10.5	100	100	100	100	8.50	CI
12	100	100	100	100	9.60	SP
13.5	100	100	100	100	40.0	CI
15	100	100	100	100	90.33	CI
16.5	100	100	100	100	92.40	CI
18	100	100	100	100	6.40	SW-SM
19.5	100	100	100	100	95.33	CI
21	100	100	100	100	16.33	SP
22.5	100	100	100	100	97.50	CI
24	100	100	100	100	96.00	CI
25.5	100	100	100	100	94.40	CI
27	100	100	100	100	97.33	CI
28.5	100	100	100	100	92.50	CI
30	100	100	100	100	96.45	CI
31.5	100	100	100	100	97.20	CI
33	100	100	100	100	93.20	CI
34.5	100	100	100	100	95.45	CI
36	100	100	100	100	96.33	CI
37.5	100	100	100	100	95.10	CI
39	100	100	100	100	96.96	CI



**Table 9: Grain size distribution corresponding to BH- 4**

Depth (m)	Percentage smaller than					Soil Group
	19	4.75	2	0.425	0.075	
	(mm)					
10.5	100	100	100	100	24.40	SC
12	100	100	100	100	18.67	SP
13.5	100	100	100	100	96.32	CI
15	100	100	100	100	21.72	SP
16.5	100	100	100	100	19.67	CI
18	100	100	100	100	6.80	SW-SM
19.5	100	100	100	100	97.33	CI
21	100	100	100	100	90.80	CI
22.5	100	100	100	100	92.73	CI
24	100	100	100	100	14.00	SM
25.5	100	100	100	100	93.33	CI
27	100	100	100	100	95.20	CI
28.5	100	100	100	100	96.33	CI
30	100	100	100	100	97.41	CI
31.5	100	100	100	100	97.60	CI
33	100	100	100	100	93.33	CI
34.5	100	100	100	100	96.67	CI
36	100	100	100	100	97.60	CI
37.5	100	100	100	100	96.33	CI
39	100	100	100	100	98.30	CI

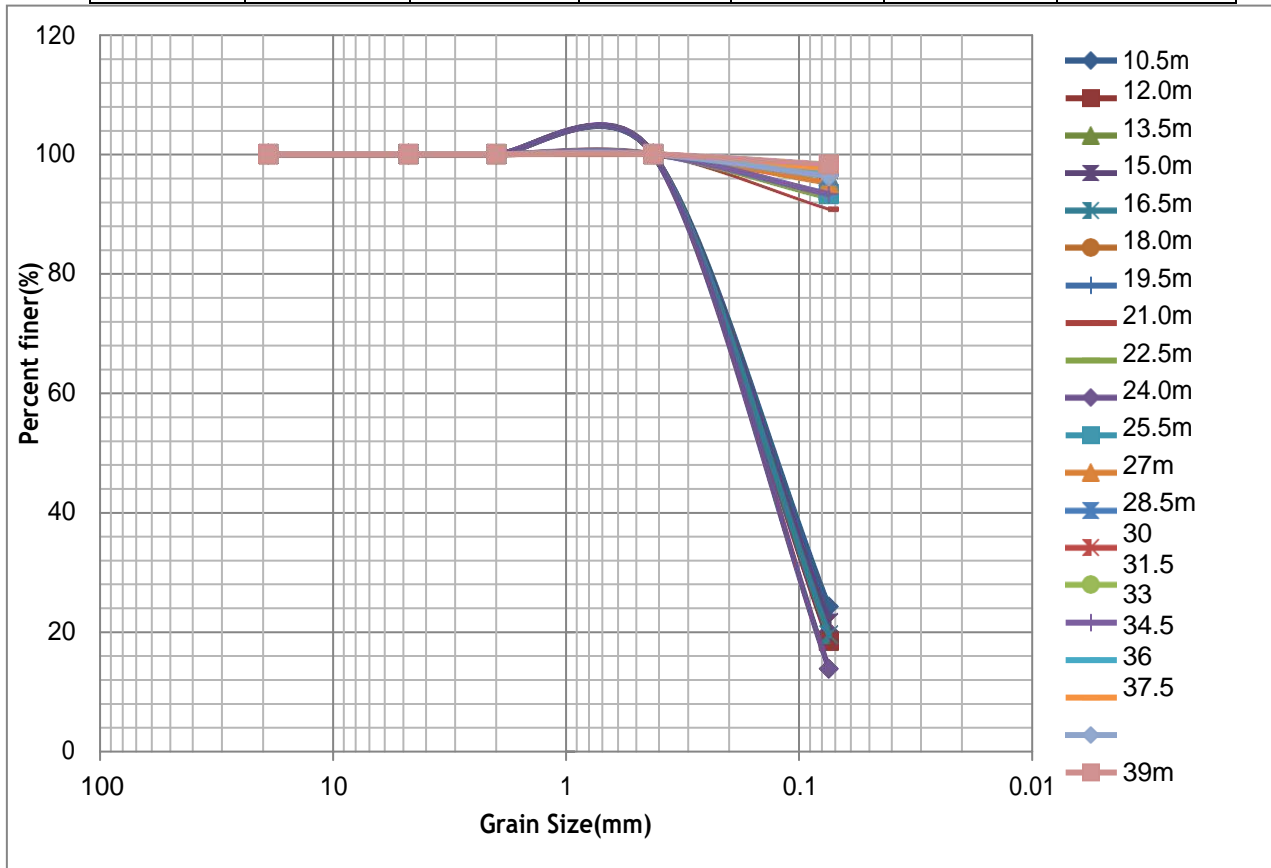

**Table 10: Grain size distribution corresponding to BH- 5**

Depth (m)	Percentage smaller than					Soil Group
	19	4.75	2	0.425	0.075	
	(mm)					
13.5	100	100	100	100	2.3	SP
15	100	100	100	100	3.6	SP
16.5	100	100	100	100	26.7	SM
18	100	100	100	100	29.6	SM
19.5	100	100	100	100	32.5	SM
21	100	100	100	100	38.2	SC
22.5	100	100	100	100	4.2	SP
24	100	100	100	100	2.6	SP
25.5	100	100	100	100	94.6	CI
27	100	100	100	100	96.7	CI
28.5	100	100	100	100	97.3	CI
30	100	100	100	100	97.2	CI
31.5	100	100	100	100	92.2	CI
33	100	100	100	100	95.3	CI
34.5	100	100	100	100	4.5	SP
36	100	100	100	77.6	3.7	SP
37.5	100	100	100	78.3	3.4	SP
39	100	100	100	100	84	SW-SM

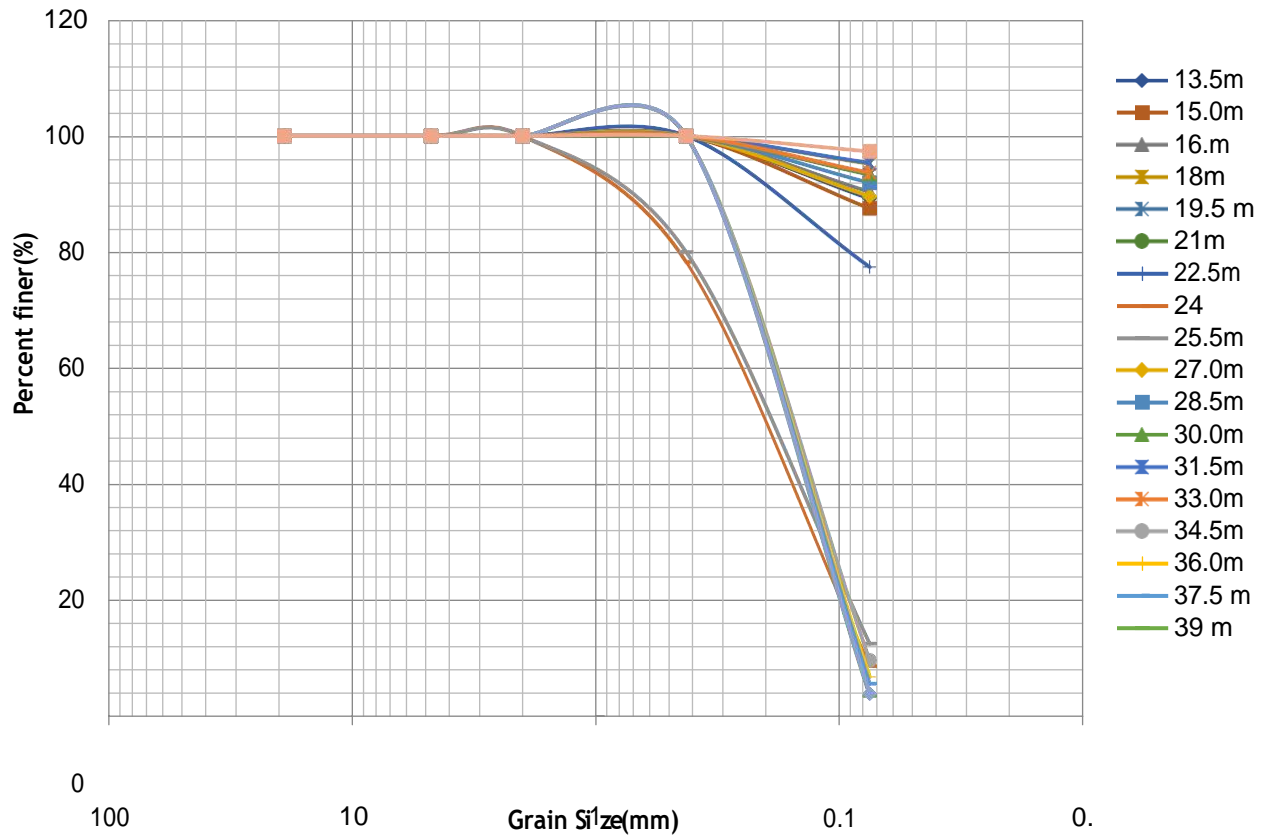

(iii) Soil consistency parameters

Table 11: Atterberg limits corresponding to BH-1

Depth (m)	Liquid Limit (%)	Plastic Limit (%)	Plasticity Index (%)
9.0	15.29	9.00	6.29
10.5	13.40	8.26	5.14
12.0	43.57	24.29	19.28
13.5	44.69	23.27	19.42
15.0	42.87	25.40	17.47
16.5	19.86	-	-
18.0	16.67	-	-
19.5	20.00	-	-
21.0	20.50	-	-
22.5	47.46	26.80	20.66
24	45.29	26.10	19.19
25.5	47.40	26.85	20.55
27	47.96	27.10	20.86
28.5	44.60	25.92	18.68
30	45.87	26.25	19.62
31.5	46.82	26.60	20.22
34	43.74	24.61	19.13
36	42.1	22.2	16.4
38	41.40	23.85	22.55

Table 12: Atterberg limits corresponding to BH-2

Depth (m)	Liquid Limit (%)	Plastic Limit (%)	Plasticity Index (%)
15.0	44.75	26.30	18.45
16.5	45.00	26.74	18.26
18.0	45.84	21.50	19.34
19.5	47.39	26.85	20.54
21.0	17.40	-	-
22.5	17.65	-	-
24	17.91	-	-
25.5	18.25	-	-
27	18.64	-	-
28.5	18.44	-	-
30	16.35	-	-
31.5	43.75	24.90	18.85
34	45.17	25.60	19.57
36	20.55	26.25	46.80
38	42.75	23.50	19.25

**Table 13: Atterberg limits corresponding to BH-3**

<b>Depth (m)</b>	<b>Liquid Limit (%)</b>	<b>Plastic Limit (%)</b>	<b>Plasticity Index (%)</b>
9.0	20.95	-	-
10.5	20.65	-	-
12.0	22.65	14.00	8.65
13.5	44.75	26.40	18.35
15.0	45.25	26.80	18.45
16.5	19.65	-	-
18.0	46.49	25.60	20.89
19.5	18.20	10.00	8.20
21.0	48.47	28.65	19.82
22.5	45.29	27.39	17.90
24	44.80	26.20	18.60
25.5	48.36	27.50	20.86
27	44.60	25.84	18.76
28.5	45.47	25.51	19.96
30	47.45	26.30	21.15
31.5	44.67	25.39	19.28
34	45.71	25.84	19.87
36	46.75	26.29	20.46
38	46.85	25.52	21.33
39	46.90	25.64	21.26

**Table 14: Atterberg limits corresponding to BH-4**

<b>Depth (m)</b>	<b>Liquid Limit (%)</b>	<b>Plastic Limit (%)</b>	<b>Plasticity Index (%)</b>
9.0	25.65	16.27	9.38
10.5	9.94	17.55	9.94
12.0	47.38	26.59	20.79
13.5	24.65	17.27	7.38
15.0	19.32	12.26	7.06
16.5	18.20	-	-
18.0	48.64	27.50	21.14
19.5	44.50	25.35	19.15
21.0	41.74	23.44	18.30
22.5	18.70	12.36	6.34
24	42.80	25.44	17.36
25.5	45.57	25.92	19.65
27	47.84	26.95	20.89
28.5	48.60	27.39	21.21
30	48.87	27.65	21.22
31.5	44.75	25.40	19.35
34	45.57	26.15	19.42
36	47.35	26.90	20.45
38	45.87	26.51	19.36
39	47.90	27.45	20.45



Table 15: Atterberg limits corresponding to BH-5

<b>Depth (m)</b>	<b>Liquid Limit (%)</b>	<b>Plastic Limit (%)</b>	<b>Plasticity Index (%)</b>
9.0	18.65	-	-
10.5	18.35	-	-
12.0	15.60	9.00	6.60
13.5	20.48	14.71	5.77
15.0	23.29	16.44	6.85
16.5	24.77	17.29	7.48
18.0	18.35	-	-
19.5	18.84	-	-
21.0	45.47	26.90	18.57
22.5	44.75	25.90	18.85
24	46.40	26.25	20.15
25.5	46.55	26.74	19.81
27	41.75	24.30	17.45
28.5	42.85	23.40	19.45
30	18.30	-	-
31.5	19.25	-	-
34	19.15	-	-
36	17.80	-	-
38	20.2	22	18

(iv) Shear strength parameters

Table 16: Shear parameters from direct shear test corresponding to BH 1 and 2

Depth (m)	BH 1		BH 2	
	Cohesion (C)	$\Phi$ (°)	Cohesion (C)	$\Phi$ (°)
7.5	95	10	15	29
9.0	1	32	31	0
10.5	86	29	85	26
12.0	88	22	12	31
13.5	94	21	90	25
15.0	11	32	11	32
16.5	90	25	101	24
18.0	12	31	13	33
19.5	85	23	94	21
21.0	95	25	88	22
22.5	86	24	86	29
24	87	25	4	30
25.5	90	25	90	25
27	85	24	85	24
28.5	105	23	104	23
30	99	26	100	26
31.5	101	24	102	25
34	95	25	96	26
36	86	29	88	23
38	95	26	89	30

**Table 17: Shear parameters from direct shear test corresponding to BH 3, 4, 5**

Depth (m)	BH 3		BH 4		BH 5	
	Cohesion (C)	$\Phi$ (°)	Cohesion (C)	$\Phi$ (°)	Cohesion(C)	$\Phi$ (°)
7.5	14	32	13	27	75	22
9.0	95	25	85	25	75	23
10.5	12	28	0	33	95	25
12.0	0	33	2	31	87	24
13.5	0	31	86	25	96	26
15.0	95	25	87	24	94	21
16.5	101	24	96	23	102	20
18.0	100	26	0	30	0	34
19.5	102	25	0	32	0	33
21.0	89	23	0	34	86	29
22.5	96	22	105	19	94	22
24	103	21	95	22	88	29
25.5	102	29	96	21	96	24
27	12	32	102	20	87	26
28.5	14	31	0	32	0	33
30	17	28	0	33	0	34
31.5	16	27	0	32	0	31
34	15	29	1	32	0	35
36	0	33	11	32	1	32
38	89	26	12	34	96	26

(v) Specific gravity and voidratio

Table 18: Unit weight, specific gravity and void ratio corresponding to BH 1 and 2

Depth	BH 1			BH 2		
	Unit weight	Specific gravity	Void ratio	Unit weight	Specific gravity	Void ratio
7.5	19.56	2.70	0.71	20.31	2.67	0.56
9.0	20.38	2.67	0.55	20.51	2.68	0.54
10.5	19.56	2.71	0.72	20.31	2.67	0.56
12.0	19.98	2.68	0.62	20.31	2.68	0.57
13.5	19.62	2.70	0.70	19.56	2.71	0.72
15.0	19.92	2.69	0.64	19.92	2.68	0.63
16.5	19.74	2.67	0.65	19.80	2.67	0.64
18.0	20.31	2.67	0.56	19.68	2.66	0.65
19.5	20.51	2.68	0.54	19.92	2.69	0.64
21.0	19.74	2.67	0.65	19.68	2.67	0.66
22.5	19.86	2.68	0.64	19.62	2.67	0.67
24	19.74	2.69	0.67	20.05	2.68	0.61
25.5	19.86	2.68	0.64	19.98	2.68	0.62
27	22.54	2.65	0.65	21.658	2.66	0.55
28.5	21.364	2.61	0.57	20.874	2.62	0.51
30	21.168	2.72	0.44	22.344	2.71	0.57
31.5	23.52	2.69	0.71	22.148	2.68	0.58
34	19.62	2.67	0.67	22.05	2.71	0.54
36	19.62	2.68	0.68	23.716	2.69	0.73
38	19.68	2.66	0.65	21.756	2.67	0.55

**Table 19: Unit weight, specific gravity and void ratio corresponding to BH 3, 4 and 5**

Depth	BH 3			BH 4			BH 5		
	Unit weight	Specific gravity	Void ratio	Unit weight	Specific gravity	Void ratio	Unit weight	Specific gravity	Void ratio
7.5	22.93	2.62	0.72	22.74	2.66	0.66	19.44	2.65	0.38
9.0	22.44	2.66	0.63	22.64	2.68	0.65	19.37	2.64	0.38
10.5	22.74	2.66	0.66	22.54	2.70	0.63	19.37	2.64	0.38
12.0	22.05	2.62	0.63	22.05	2.69	0.60	19.89	2.65	0.32
13.5	21.85	2.65	0.58	23.23	2.65	0.71	19.88	2.66	0.33
15.0	22.93	2.66	0.68	22.74	2.66	0.69	19.89	2.65	0.32
16.5	22.83	2.63	0.70	22.44	2.63	0.67	20.04	2.66	0.31
18.0	23.52	2.67	0.73	23.32	2.65	0.68	19.47	2.71	0.43
19.5	23.52	2.64	0.76	23.32	2.66	0.69	19.68	2.71	0.4
21.0	22.15	2.60	0.66	21.04	2.66	0.45	19.56	2.68	0.39
22.5	22.93	2.71	0.63	21.10	2.68	0.46	19.7	2.69	0.38
24	23.42	2.69	0.70	21.09	2.69	0.47	19.27	2.7	0.45
25.5	22.34	2.68	0.60	20.90	2.65	0.46	19.44	2.65	0.38
27	19.62	2.67	0.67	21.34	2.68	0.43	19.37	2.64	0.38
28.5	19.62	2.68	0.68	21.35	2.67	0.42	18.83	2.66	0.48
30	19.68	2.66	0.65	20.58	2.69	0.54	18.76	2.66	0.49
31.5	21.10	2.68	0.46	19.50	2.65	0.67	20.438	2.64	0.42
34	20.66	2.67	0.51	19.56	2.67	0.68	19.654	2.6	0.38
36	21.49	2.69	0.42	19.74	2.66	0.64	21.124	2.69	0.44
38	20.58	2.69	0.54	20.96	2.66	0.46	20.72	2.61	0.19

## 9.0 SAFE LOAD CAPACITY FOR BORED CAST IN-SITU REINFORCED CONCRETE PILE

This section provides the Safe Load Carrying Capacity of few piles of predetermined diameter and length. For calculating the Safe Load Carrying Capacity, design philosophy as suggested by IS: 2911 (Part I) -1979 is followed. The Ultimate Load Capacity of each pile is determined using Static Pile Load Formulae considering shear criteria.

The Ultimate Load Capacity is calculated as,

$$Q_u = Q_b + Q_f$$

Where,  $Q_b$  = Load carried by Point Bearing =  $q_{pu}A_b$

$Q_f$  = Load carried by Skin Friction =  $f_s A_s$

Again,

$$Q_u = q_{pu}A_b + f_s A_s$$

Where,

$q_{pu}$  = Unit End Bearing Resistance

$A_b$  = Sectional area of the pile at its base

$f_s$  = Unit Skin Friction Resistance of a particular layer

$A_s$  = Surface Area of the pile in contact with the particular soil layer

Safe Load Capacity,

$$Q_s = Q_u / \text{F.O.S.} \quad \text{F.O.S.} = \text{Factor of Safety} = 2.5$$

The Ultimate Pullout Resistance is calculated as,

$$Q_{ut} = f_s A_s + W_p,$$

Where,

$W_p$  = Weight of the pile Safe Load Capacity,

Again,  $Q_{st} = Q_{ut} / \text{F.O.S.}$       F.O.S. = Factor of Safety

Table 20: Safe Load Capacity of Bored Cast In-Situ Uniform Shaft Pile

Length of Pile	Diameter of Pile(mm)	B.H=1		B.H= 2		B.H=3	
		Design Safe Load (tons)	Design Safe Uplift Load (tons)	Design Safe Load (tons)	Design Safe Uplift Load (tons)	Design Safe Load (tons)	Design Safe Uplift Load (tons)
15	400	47.81	37.53	46.88	36.82	48.28	37.88
16	400	50.69	40.03	49.69	39.28	51.18	40.40
17	400	53.56	42.53	52.51	41.73	54.09	42.93
18	400	56.44	45.03	55.33	44.19	56.99	45.45
19	400	59.31	47.53	58.15	46.64	59.89	47.98
20	400	62.18	50.04	60.96	49.10	62.79	50.50
21	400	65.06	52.54	63.78	51.55	65.70	53.03
22	400	67.93	55.04	66.60	54.01	68.60	55.56
23	400	70.81	57.54	69.42	56.46	71.50	58.08
24	400	73.68	60.04	72.24	58.92	74.40	60.61
25	400	76.55	62.54	75.05	61.37	77.30	63.13
26	400	79.43	65.05	77.87	63.82	80.21	65.66
27	400	82.30	67.55	80.69	66.28	83.11	68.18
28	400	85.18	70.05	83.51	68.73	86.01	70.71
29	400	88.05	72.55	86.32	71.19	88.91	73.23
30	400	90.92	75.05	89.14	73.64	91.82	75.76
31	400	93.80	77.55	91.96	76.10	94.72	78.28
32	400	96.67	80.06	94.78	78.55	97.62	80.81
33	400	99.55	82.56	97.59	81.01	100.52	83.33
34	400	102.42	85.06	100.41	83.46	103.42	85.86
35	400	105.29	87.56	103.23	85.92	106.33	88.38
36	400	108.17	90.06	106.05	88.37	109.23	90.91
37	400	111.04	92.57	108.86	90.83	112.13	93.43
38	400	113.92	95.07	111.68	93.28	115.03	95.96
39	400	116.79	97.57	114.50	95.74	117.94	98.48
15	500	61.24	47.41	60.04	46.53	61.84	47.85
16	500	64.83	50.57	63.56	49.63	65.46	51.04
17	500	68.42	53.73	67.08	52.73	69.09	54.23
18	500	72.01	56.89	70.60	55.83	72.72	57.42
19	500	75.61	60.05	74.12	58.94	76.35	60.61
20	500	79.20	63.21	77.65	62.04	79.98	63.80
21	500	82.79	66.37	81.17	65.14	83.60	66.99
22	500	86.38	69.53	84.69	68.24	87.23	70.18
23	500	89.98	72.69	88.21	71.34	90.86	73.37
24	500	93.57	75.85	91.73	74.44	94.49	76.56
25	500	97.16	79.01	95.26	77.55	98.11	79.75
26	500	100.75	82.17	98.78	80.65	101.74	82.94
27	500	104.35	85.33	102.30	83.75	105.37	86.13
28	500	107.94	88.50	105.82	86.85	109.00	89.32
29	500	111.53	91.66	109.35	89.95	112.63	92.51
30	500	115.12	94.82	112.87	93.06	116.25	95.70
31	500	118.72	97.98	116.39	96.16	119.88	98.89

32	500	122.31	101.14	119.91	99.26	123.51	102.08
33	500	125.90	104.30	123.43	102.36	127.14	105.27
34	500	129.49	107.46	126.96	105.46	130.76	108.46
35	500	133.09	110.62	130.48	108.56	134.39	111.65
36	500	136.68	113.78	134.00	111.67	138.02	114.84
37	500	140.27	116.94	137.52	114.77	141.65	118.03
38	500	143.86	120.10	141.04	117.87	145.28	121.22
39	<u>500</u>	<u>147.46</u>	123.26	144.57	120.97	148.90	124.41



**Table 21: Safe Load Capacity of Bored Cast In-Situ Uniform Shaft Pile**

Length of Pile	Diameter of Pile(mm)	B.H=4		B.H= 5	
		Design Safe Load (tons)	Design Safe Uplift Load (tons)	Design Safe Load (tons)	Design Safe Uplift Load (tons)
15	400	49.70	39.26	50.72	40.02
16	400	52.72	41.87	53.79	42.69
17	400	55.73	44.49	56.87	45.36
18	400	58.74	47.11	59.94	48.03
19	400	61.75	49.72	63.01	50.70
20	400	64.77	52.34	66.09	53.37
21	400	67.78	54.96	69.16	56.03
22	400	70.79	57.57	72.24	58.70
23	400	73.80	60.19	75.31	61.37
24	400	76.82	62.81	78.38	64.04
25	400	79.83	65.43	81.46	66.71
26	400	82.84	68.04	84.53	69.37
27	400	85.85	70.66	87.60	72.04
28	400	88.86	73.28	90.68	74.71
29	400	91.88	75.89	93.75	77.38
30	400	94.89	78.51	96.83	80.05
31	400	97.90	81.13	99.90	82.72
32	400	100.91	83.74	102.97	85.38
33	400	103.93	86.36	106.05	88.05
34	400	106.94	88.98	109.12	90.72
35	400	109.95	91.60	112.19	93.39
36	400	112.96	94.21	115.27	96.06
37	400	115.98	96.83	118.34	98.73
38	400	118.99	99.45	121.42	101.39
39	400	122.00	102.06	124.49	104.06
15	500	63.54	49.57	64.84	50.53
16	500	67.31	52.87	68.68	53.90
17	500	71.07	56.18	72.52	57.27
18	500	74.84	59.48	76.37	60.64
19	500	78.60	62.79	80.21	64.00
20	500	82.37	66.09	84.05	67.37
21	500	86.13	69.40	87.89	70.74
22	500	89.90	72.70	91.73	74.11
23	500	93.67	76.01	95.58	77.48
24	500	97.43	79.31	99.42	80.85
25	500	101.20	82.62	103.26	84.22
26	500	104.96	85.92	107.10	87.59
27	500	108.73	89.23	110.95	90.95
28	500	112.49	92.53	114.79	94.32
29	500	116.26	95.83	118.63	97.69
30	500	120.02	99.14	122.47	101.06
31	500	123.79	102.44	126.32	104.43
32	500	127.55	105.75	130.16	107.80
33	500	131.32	109.05	134.00	111.17

34	500	135.09	112.36	137.84	114.53
35	500	138.85	115.66	141.68	117.90
36	500	142.62	118.97	145.53	121.27
37	500	146.38	122.27	149.37	124.64
38	500	150.15	125.58	153.21	128.01
39	500	153.91	128.88	157.05	131.38

Table 21: Safe Bearing Capacity for shallow foundation

Foundation Size (m)	Foundation Depth (m)	BH-1	BH-2	BH-3
		Recommended net safe bearing Capacity (ton/sqm)	Recommended net safe bearing Capacity (ton/sqm)	Recommended net safe bearing Capacity (ton/sqm)
2 X 2	3	3.6	4.02	3.6
3 X 3	3	3.7	4.1	3.7

Table 22: Safe Bearing Capacity for shallow foundation

Foundation Size (m)	Foundation Depth (m)	BH-4	BH-5
		Recommended net safe bearing Capacity (ton/sqm)	Recommended net safe bearing Capacity (ton/sqm)
2 X 2	3	3.3	3.5
3 X 3	3	3.4	3.6

FOS=3 is used in both the foundations

## SUMMARY AND CONCLUSIONS

Field exploratory and laboratory tests reveal that the subsoil in general consists of clayey silt/clayey sand layer up to explored depth

On the basis of a careful examination of the field and laboratory test results as well as the analysis results, following recommendations are made.

1. Pile foundation with diameter 0.4m and 0.5m are recommended for the tested soil upto a length of at least 15m.
  2. Shallow foundation of size 2m x 2m and 3m x 3m is also recommended and the net safe bearing capacity is mentioned.
- For heavy superstructure loads, bored and cast-in-situ piles of various length and diameter may be used. Table shows the load capacity of 400& 500mm uniform shaft piles.
  - However, it is emphasized that as piles are installed in groups, group action of piles is to be considered in the design. Spacing of the piles is to be selected so that 100% pile group efficiency is achieved.
  - It is also emphasized that load capacity formulae for piles (static formulae or other empirical correlations) may be used as a guide for bearing capacity estimates. Better reliance should be put on load test on piles.
  - If manual boring for installation of piles is followed, sufficiently long casing pipes are to be installed during boring to prevent side soil from collapse.
  - Changes in the value of the bearing capacity may be made in accordance with IS: 1893-2002 if earthquake load is considered in the analysis.

ANNEXURE-2 - SITE PLAN

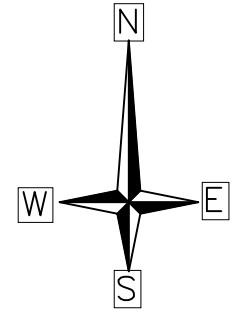
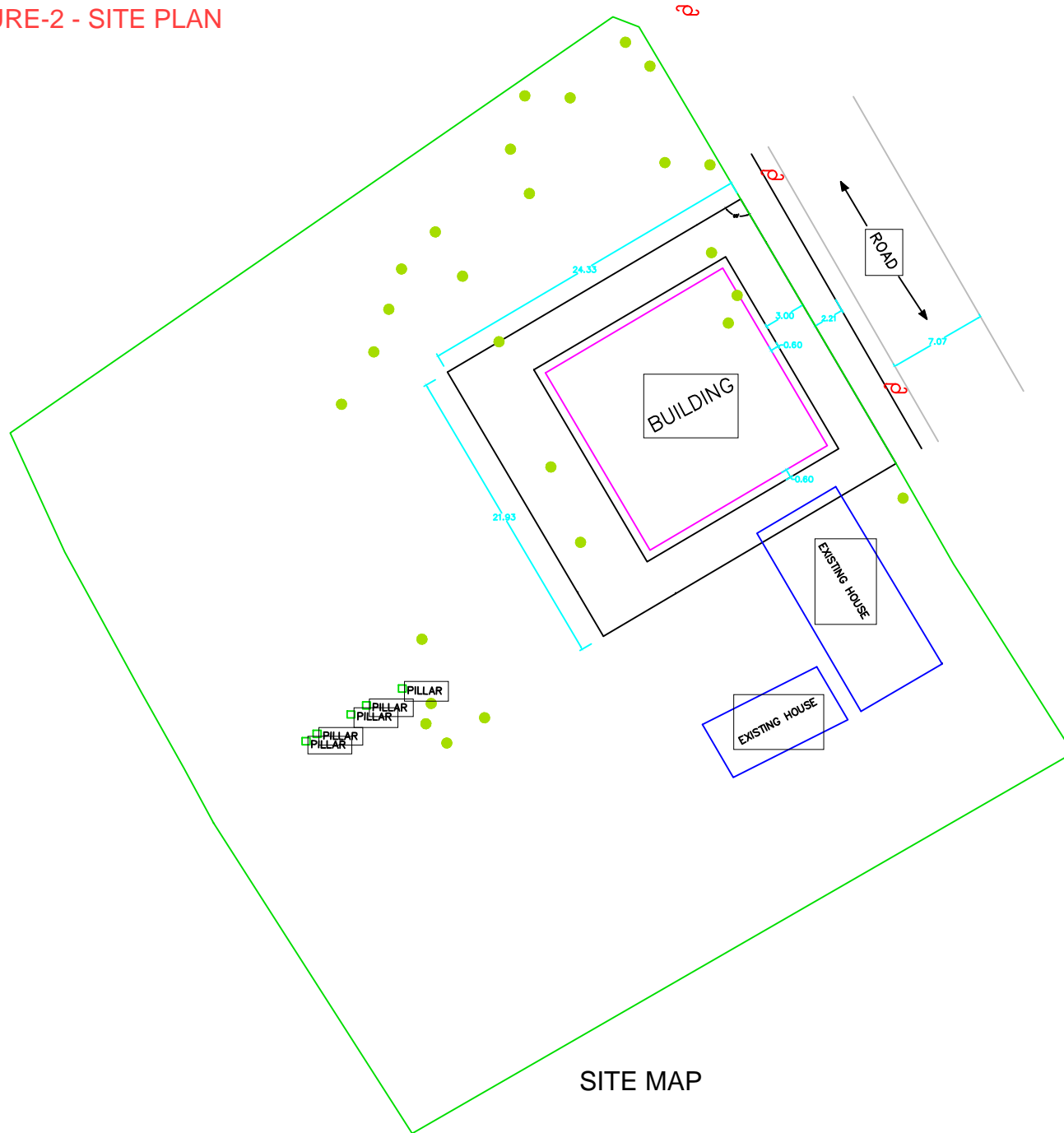

LEGEND:

- TREES
- ⊕ TRNSFORMER
- GATE
- WALL

PROJECT: TOPOGRAPHICAL SURVEY FOR PROPOSED CONSTRUCTION OF COC BUILDING AT PANJABARI, GUWAHATI

CLIENT: GUWAHATI METROPOLITAN DEVELOPMENT AUTHORITY

CONSULTANT: M/S RAJKHOWAS AARCHI, GUWAHATI

Name of Surveyor:  
DEBAJIT BORAH

Name of Draftsman:  
S. SAHA

Scale: 1:100

ANNEXURE-3 - SPOT LEVELS

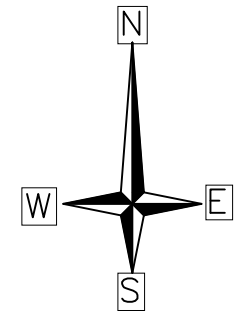
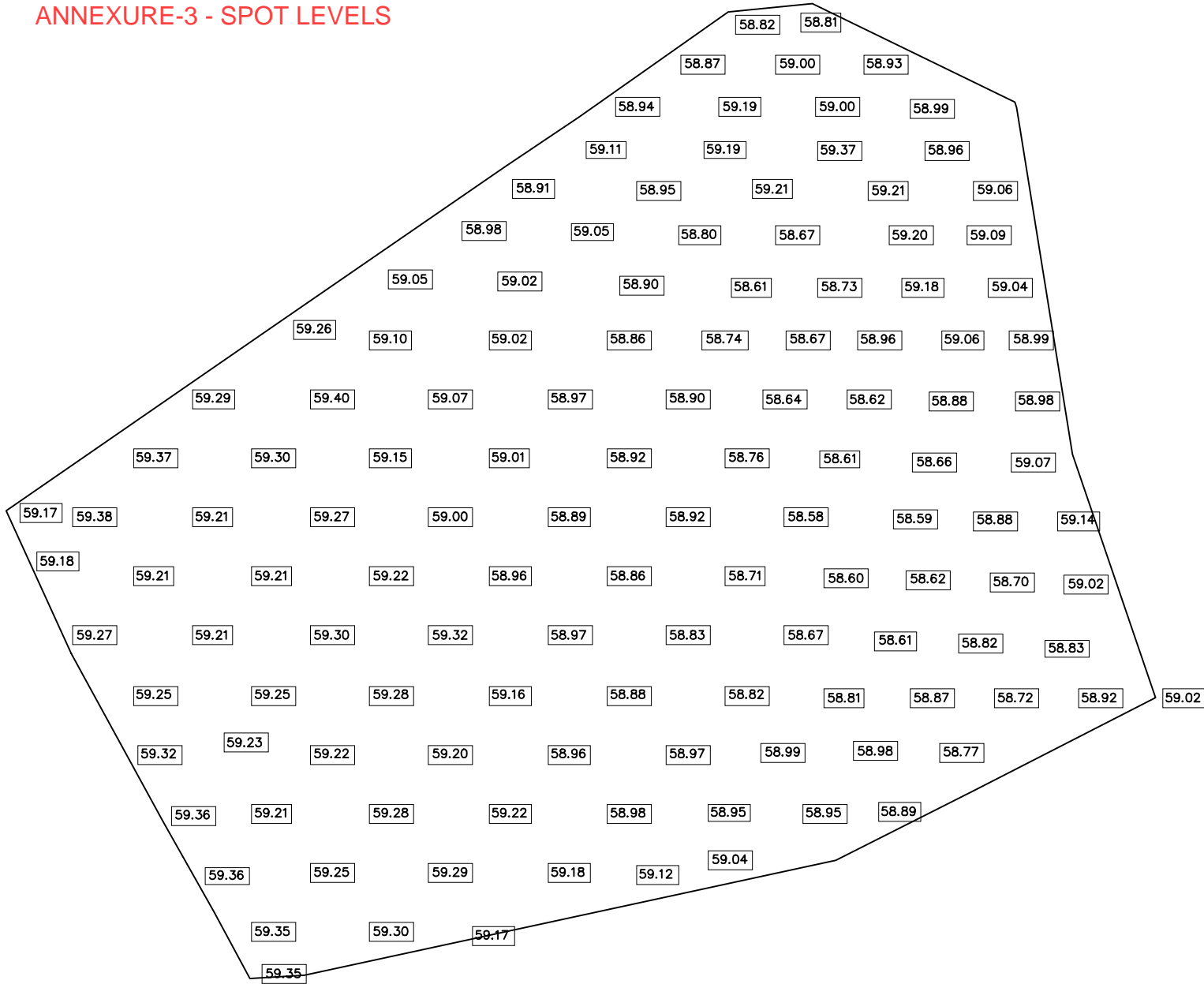

PROJECT: TOPOGRAPHICAL SURVEY FOR PROPOSED CONSTRUCTION OF COC BUILDING AT PANJABARI, GUWAHATI

CLIENT: GUWAHATI METROPOLITAN DEVELOPMENT AUTHORITY

CONSULTANT: M/S RAJKHOWAS AARCHI, GUWAHATI

Name of Surveyor:  
DEBAJIT BORAH

Name of Draftsman:  
S. SAHA

Scale: 1:100

**SCHEDULE F – SAFETY CONDITIONS**

SPEC.NO TCE.M4-917	<b>TATA CONSULTING ENGINEERS LIMITED</b>	SECTION: WRITE-UP
	<b>Safety Conditions for undertaking site work</b>	SHEET 1 OF 15

**1.0 SCOPE**

This document gives broad guidelines to be followed by the CONTRACTOR for ensuring safe working conditions in and around the site.

**2.0 SAFETY ORGANISATION**

- 2.1) Each CONTRACTOR at site shall establish a Safety organization set up at site consisting of qualified safety officers, safety supervisors and stewards as per requirement. Safety officer who shall be responsible for administering safety functions like planning and implementing site inspections, audits, examination / testing, safety surveys, providing supervision, monitoring safe working conditions at all times for their workers. The Safety Officer shall have a degree or diploma in engineering, and diploma in Industrial Safety from recognised central/state government approved institute and also field experience of minimum 03 years in case of degree in engineering or minimum 05 years in case of diploma in engineering, in the relevant discipline. The safety officer shall also have the authority to stop / suspend the unsafe practices and works taken up in unsafe conditions.
- 2.2) CONTRACTOR shall define the roles and responsibilities of all the personnel at different levels in the safety organization in the CONTRACTOR's Site Safety Plan.
- 2.3) CONTRACTOR shall take active interest and participate in the development and operation of safety programs at site. His responsibility does not cease with establishment of Safety Group and approval of its various activities. He shall demonstrate his involvement by regular participation in safety meetings, review of safety records and taking corrective action where required, introduction of safety promoting bulletins, posters, suggestions and awards and by setting example by strictly observing safety rules. CONTRACTOR shall remove all waste material and debris from and around the work area and properly clean up the area at the end of each day before leaving the work site.
- 2.4) CONTRACTOR shall take all necessary precautions not only for safe working of his own workmen but also deploy all precautions to ensure safety of structures, equipment and workmen of other agencies in and around his work site.

FILE NAME:TCE.M4-917-R4.docx

Proprietary rights of the information contained herein belong to Tata Consulting Engineers Limited (TCE). This information is intended to be used for the mentioned purpose/project only. In case of misuse of information and any claim arising thereof, cost and consequence will be on the party misusing the information.

ISSUE R4
-------------



SPEC.NO TCE.M4-917	<b>TATA CONSULTING ENGINEERS LIMITED</b>	SECTION: WRITE-UP
	<b>Safety Conditions for undertaking site work</b>	SHEET 2 OF 15

2.5) CONTRACTOR shall ensure that his workmen do not trespass into prohibited/restricted work areas.

2.6) EMPLOYER/CONSULTANT shall have the right to inspect at any time, all items of machinery, plant and equipments (owned, borrowed / sub-contracted, leased, rented) brought to site by the CONTRACTOR or his agents or workmen and to prohibit the use on the site of any item, which in the opinion of the EMPLOYER/CONSULTANT is or may be detrimental to the safety of the site. The exercise of such right or the omission to exercise it in any particular case shall not absolve the CONTRACTOR or his agents or workmen of their responsibility of adhering to the safe working practices.

2.7) CONTRACTOR shall execute the work in a manner causing the least possible interference with the business of the EMPLOYER/CONSULTANT, or with the work of any other CONTRACTOR who may be engaged on the premises and shall at all times co-operate with the other CONTRACTORS working at site.

2.8) CONTRACTOR shall obtain daily work permit from the EMPLOYER/CONSULTANT before start of any work at site. The work permits are issued to prevent the CONTRACTOR from working in unauthorised areas and shall be valid for specific area for a stipulated period.

2.9) CONTRACTOR shall ensure at all times that his workers do not lie down or sleep under or around any machine, equipment, vessel or vehicle in his work area at any time.

#### **2.10 RESPONSIBILITIES OF THE CONTRACTOR'S SAFETY OFFICER**

The duties of a safety officer shall be to advise and assist the CONTRACTOR's management in the fulfilment of its obligations, statutory or otherwise concerning prevention of personnel injuries and maintaining a safe working environment. These duties shall include the following namely:

- a) To advise the building workers in planning and organising measures necessary for effective control of personal injuries.
- b) To advise on safety aspects in a construction work and to carry out detailed safety studies of selected activities.
- c) To check and evaluate the effectiveness of action taken or proposed to be taken to prevent personal injuries.
- d) To advise purchasing and ensuring quality of personal protective equipment confirming to national standards.

ISSUE R4
-------------

SPEC.NO TCE.M4-917	<b>TATA CONSULTING ENGINEERS LIMITED</b>	SECTION: WRITE-UP
	<b>Safety Conditions for undertaking site work</b>	SHEET 3 OF 15

- e) To carry out safety inspections of construction work in order to observe the physical conditions of work and the work practices and procedures followed by construction workers and to render advise on measures to be adopted for removing unsafe physical conditions and preventing unsafe actions by construction workers.
- f) To investigate the near misses, incidents and major accidents and submit the detail report to EMPLOYER/CONSULTANT.
- g) To promote the working of safety committees and to act as an advisor to such committees.
- h) To design and conduct, either independently or in collaboration with other agencies, suitable training and educational programmes for prevention of accidents to building workers.
- i) To frame operational control measures, safe rules and safe working practices in consultation with senior officials of the establishment.
- j) Supervise and guide safety precautions to be taken in construction work of the establishment.
- k) Ensure compliance to legal and contractual requirements affecting safety, health, and welfare of his workmen.
- l) Keeping up-do-date with recommended codes of practice and safety literature. Circulating information applicable to each level of employees.
- m) Fostering within the company an understanding that injury prevention and damage control are an integral part of business and operational efficiency.
- n) Attending job progress meetings where safety is a point on the agenda. Report on job safety performance.

**3.0 Entry and Exit procedures:**

- 3.1) CONTRACTOR must follow Entry / Exit to the project premises for all the project employee and materials will be from the designated entrance / exit point only.
- 3.2) CONTRACTOR must follow entry / exit systems through Photo ID card / bio-metric.

ISSUE R4
-------------

SPEC.NO TCE.M4-917	<b>TATA CONSULTING ENGINEERS LIMITED</b>	SECTION: WRITE-UP
	<b>Safety Conditions for undertaking site work</b>	SHEET 4 OF 15

- 3.3) CONTRACTOR must follow Entry to the project premises with mandatory PPE's (safety helmet, shoe & reflective jackets).
- 3.4) The record of Entry / Exit of the personnel will be maintained by the security / time keeper at the gate by CONTRACTOR.
- 3.5) Vehicles of the CONTRACTORs must be parked only at the designated parking lots in the project premises.
- 3.6) General Safety awareness posters to be displayed at the entrance and exit gate points by CONTRACTOR.
- 3.7) CONTRACTOR must provide separate access for pedestrian/vehicles movement at the entry / exit Points.
- 3.8) ID cards should be displayed by all contract workmen at the entry / exit points.
- 3.9) CONTRACTOR must provide one full time ambulance and it must be parked near the Entry gate or at the First aid center manned by an experienced driver.
- 3.10) CONTRACTOR's Plant and Equipments will be screened at the gate before being deployed at site by Employer/Consultant.
- 3.11) Permission for Entry/Exit of CONTRACTOR's Plant and Equipments into project premises must be through Employer/Consultant.
- 3.12) The CONTRACTOR shall arrange to separate pedestrian and vehicular (including material handling equipment) traffic wherever possible and maintain the routes clear of obstruction. To ensure safety of users' clear painted demarcation is encouraged as a discipline to be enforced.

**4.0 STACKING AND STORAGE PRACTICE**

- 4.1) All construction materials should be stored in designated areas. The CONTRACTOR shall submit a detailed scheme of construction and other hazardous materials' storage, stacking, dispensing and disposal also considering the physical and chemical properties along with the statutory requirements.
- 4.2) The CONTRACTOR shall ensure stacked material is bonded on a stable and level footing capable of carrying the mass of the stack. Adequate clearances

ISSUE R4
-------------

SPEC.NO TCE.M4-917	<b>TATA CONSULTING ENGINEERS LIMITED</b>	SECTION: WRITE-UP
	<b>Safety Conditions for undertaking site work</b>	SHEET 5 OF 15

shall be provided between the sides of the stack and top to facilitate unimpeded access to service equipment like overhead wiring, cranes, forklifts and fire fighting equipment, and hoses. Circular items shall be sufficiently choked with wedges not with odd bits of materials. Free-standing stacks of gunny bags and sacks such as cement bags shall be stacked to prescribed safe-stack heights with layers formed for stable bonding, preventing slippage causing accidents. Stacking against walls shall not be permissible.

4.3) The CONTRACTOR shall maintain the premises and surrounding areas in clean and clear manner with safe access and egress.

**5.0 STORAGE OF HAZARDOUS MATERIALS**

5.1) CONTRACTOR shall store the Hazardous materials on solid bases. Solid bases shall include compacted earth, pallets, concrete or asphalt platforms or paving. Hazardous materials shall be stored, stacked and secured to prevent toppling, Spillage or other unintended dislodgement. Aisles and clearances shall be detailed as per requirement. Hazardous materials shall be stacked in such a manner that an observer standing in the aisle can read their labels and legend.

5.2) CONTRACTOR must provide each hazardous material contained be identified by a legible or legend as per governing statute, code or regulation. The label shall identify the item, quantity and appropriate warnings.

5.3) Hazardous materials which if brought in contact with each other could react or pose equal or greater hazard than either material stored alone shall be stored at a distance not lesser than twenty feet apart by CONTRACTOR.

5.4) CONTRACTOR shall display/post the Warnings and maintain it in a legible condition at all access points clearly defining the specific hazardous nature of the stored materials such as 'Explosive', 'Compressed Gas' , 'Flammable', 'Oxidising', 'Corrosive' or other hazardous nature.

5.5) Where hazardous materials are unloaded in the CONTRACTOR's storage maintained at site in a semi-permanent installation, such installations shall be approved by relevant statutory bodies. Copies of licences for storage shall be lodged with the EMPLOYER. The containers and storage shall display quantities stored with name of the hazardous material and the UN hazard classification label in prescribed colour code prominently painted in a conspicuous manner.

5.6) The CONTRACTOR shall inspect the hazardous storages and installations on a daily basis and shall undertake any requisite preventive action necessary to avoid safety risks.

ISSUE R4
-------------

SPEC.NO TCE.M4-917	<b>TATA CONSULTING ENGINEERS LIMITED</b>	SECTION: WRITE-UP
	<b>Safety Conditions for undertaking site work</b>	SHEET 6 OF 15

**6.0 STORAGE OF FLAMMABLE AND EXPLOSIVE MATERIALS**

- 6.1) CONTRACTOR shall secure flammable and or explosive materials against accidental ignition.
- 6.2) CONTRACTOR storage facilities for flammable liquids such as petrol, diesel, kerosene and lubricants as well as the quantities stored shall meet the legal and statutory requirements. These shall be stored in approved fire-resistant rooms with a sump of sufficient volume to contain any spillage.
- 6.3) CONTRACTOR shall provide the electrical fittings with flame proof and follow a strict maintenance schedule. Containers shall be appropriately bonded in receptacles into which low flash point fuel is decanted.

**7.0 COMPRESSED GAS CYLINDERS**

CONTRACTOR should store the compressed gas cylinders and secure it in the upright position at safe distances shielded from welding and cutting operations/hot work. Compressed gas cylinders in storage shall be shut off and torches, hose and manifolds removed and capped. Cylinders shall be periodically checked for leakages, if any. Compressed gas storages shall be provided with safety relief valves, Safety valves and rupture disc to protect them from overpressures.

**8.0 VEHICLES/MACHINERY MOVEMENT IN PROJECT PREMISES**

- 8.1) CONTRACTOR vehicles shall have valid registration , insurance, PUC, and road permit in conformance with regulations and always keep copies of valid travelling documents in the vehicle (Driving license, registration, insurance, and identity card and contact details).
- 8.2) CONTRACTOR vehicles (Four Wheelers) shall be equipped with seat belts both in front and rear seats, first aid box, portable fire extinguisher, standard stopper (wheel choke), emergency reflective triangles, etc. The drivers should be trained to use fire extinguishers.
- 8.3) CONTRACTOR vehicles operating on site shall be fitted with reverse horn, rear view mirror and driver shall always be accomplished by trained co-driver / helper.
- 8.4) CONTRACTOR vehicles shall be well maintained and kept in perfect working order and fully equipped with the proper safety gear. Conduct regular checks of the vehicle's condition and report defects immediately. Any defect has to be

ISSUE R4
-------------

SPEC.NO TCE.M4-917	<b>TATA CONSULTING ENGINEERS LIMITED</b>	SECTION: WRITE-UP
	<b>Safety Conditions for undertaking site work</b>	SHEET 7 OF 15

removed as soon as practicable, before the vehicle is put in use. Toeing of vehicle with the help of Hydra or back push from other vehicle is strictly prohibited on site.

- 8.5) CONTRACTOR shall have driver/operator medical fitness report as per regulation; at least once a year and copy of medical report shall be available with driver/operator.
- 8.6) CONTRACTOR drivers shall have an experience of minimum 5 years and age should be between 25 and 58 years (holding Heavy vehicle license).
- 8.7) All employees including CONTRACTOR shall wear crash helmet and shoes while driving motorbike. Safety helmets provided for project / site work shall not be worn as crashed helmets, as they are not adequate to withstand the impact caused during accident of vehicle (two-wheeler). Two wheel drivers shall use adequate crash helmets of approved ISI mark.
- 8.8) Any new CONTRACTOR driver before starting driving shall attend authorized training program for safe driving as per regulation.
- 8.9) CONTRACTOR drivers shall have his journey schedule showing expected date and time to complete the journey.
- 8.10) CONTRACTOR drivers shall ensure to take minimum 15 minutes rest for every 4 hrs of continuous journey. Also shall not drive more than 12 hrs in a day.
- 8.11) CONTRACTOR drivers shall operate only those vehicles for which they are trained, authorized and licensed.
- 8.12) Without proper authorization by EMPLOYER/CONSULTANT CONTRACTOR respective drivers/operators shall not operate any vehicle other than they are authorized to operate, even if they are capable of such operation.
- 8.13) CONTRACTOR shall ensure that the person in the driver's seat as well as others in the vehicle shall keep seat belts fastened, while the vehicle is in motion.
- 8.14) CONTRACTOR shall specify and safe speed limits to be observed and maintained at all times.
- 8.15) CONTRACTOR must specify vehicle operating instructions.

ISSUE R4
-------------

SPEC.NO TCE.M4-917	<b>TATA CONSULTING ENGINEERS LIMITED</b>	SECTION: WRITE-UP
	<b>Safety Conditions for undertaking site work</b>	SHEET 8 OF 15

- 8.16) CONTRACTOR must ensure safe driving during bad weather conditions (rain showers, winds, snow, etc.) with utmost care.
- 8.17) CONTRACTOR must ensure that, mobile phones are not to be used whilst driving or operating a vehicle.
- 8.18) CONTRACTOR must display that Driving under the influence of alcohol or any sedative drug (including prescribed medication) is strictly prohibited.
- 8.19) CONTRACTOR shall ensure that eating, drinking (even non-alcoholic beverages), etc. during driving inside the project premises be avoided. Such activities increase the risk of accident due to distraction and lack of concentration.
- 8.20) When loading and unloading, the CONTRACTOR shall observe relevant guidelines and requirements to avoid danger to any person or damage to any property.
- 8.21) Drivers/Operators shall not attend to mobile calls/listen to music while driving the vehicles/machinery.

**9.0 Excavation**

- 9.1) As built drawings of underground services must be referred by the CONTRACTOR before starting the excavation activity.
- 9.2) CONTRACTOR should make detail excavation methodology and submit the Methodology for approval to EMPLOYER/CONSULTANT.
- 9.3) CONTRACTOR must ensure the stability of structure adjoining the workplace or other areas to be excavated by providing safety measures like Sheet piling, shoring or other similar means to support structure.
- 9.4) CONTRACTOR should provide a safe access by providing ladders, staircase or ramps.
- 9.5) CONTRACTOR should ensure at a construction site that any machinery used in excavation is positioned and operated in such a way that such machinery does not endanger the operator of such machinery.
- 9.6) In the event of an excavation or removing a manhole cover, the CONTRACTOR should ensure that any opening, sump or pit caused is securely fenced and covered before leaving the workplace for the day.

ISSUE R4
-------------

SPEC.NO TCE.M4-917	<b>TATA CONSULTING ENGINEERS LIMITED</b>	SECTION: WRITE-UP
	<b>Safety Conditions for undertaking site work</b>	SHEET 9 OF 15

9.7) Hard barricading should be provided around excavation area by CONTRACTOR.

9.8) Excavated earth must be placed 2m away from the excavated area and Suitable warning boards and signs should be put up by CONTRACTOR near excavation work area.

**10.0 Scaffolds**

10.1) Before erecting scaffold at site, CONTRACTOR has to get approved the scaffold design/drawings from EMPLOYER / CONSULTANT.

10.2) Scaffold materials must be as per IS standard.

10.3) Competent person must be involved in scaffold erection.

10.4) CONTRACTOR must use Mandatory scaffold components Base plate, ladders, Steel platform (tied with the scaffold), mid rail, Hand rail, Toe board (150 MM), bracings while erecting the scaffold.

10.5) EMPLOYER/CONSULTANT will inspect the CONTRACTOR scaffolding whether erected scaffold is as per the approved design.

10.6) SCAFF tag must be followed (Red Tag- Unsafe/Not to use, Green Tag – Safe to use).

10.7) CONTRACTOR must ensure usage of mobile scaffold is strictly prohibited.

10.8) CONTRACTOR must provide the scaffold with proper fall protection system intact and display the suitable warning boards.

10.9)CONTRACTOR must ensure area to be barricaded during erection and dismantling of scaffolds.

**11.0 WORKING AT HEIGHTS**

11.1) CONTRACTOR workmen engaged must undergo medical fitness examination before deploying them for work at heights.

11.2) CONTRACTOR workers should wear safety full body harness with double lanyard with hook properly fastened.

11.3) CONTRACTOR workmen engaged on work at heights should be experienced in such work.

ISSUE R4
-------------



SPEC.NO TCE.M4-917	<b>TATA CONSULTING ENGINEERS LIMITED</b>	SECTION: WRITE-UP
	<b>Safety Conditions for undertaking site work</b>	SHEET 10 OF 15

- 11.4) Steel scaffold staging should be erected as per IS code and the design for Scaffold staging must be submitted to EMPLOYER/CONSULTANT for approval.
- 11.5) Wherever multiple work activities CONTRACTOR must use safety nets beneath the place of work for safety.
- 11.6) CONTRACTOR when working over equipments or tanks, Full body safety harness with double lanyard, safety lifeline and safety nets should always be used whether or not staging and scaffolding is provided.
- 11.7) Safe access to all points of works should be provided in the form of Suitable Ladders /stairways/ boom lifts by CONTRACTOR.
- 11.8) Area around the work place should be barricaded suitably or fenced off to avoid Injuries to personnel passing by. Suitable warning boards and sign should be put up by CONTRACTOR.
- 11.9) Life line and fall protection arrangements should be provided for working at heights by CONTRACTOR
- 11.10) CONTRACTOR must ensure loose materials should be cleared on daily basis from scaffolds.
- 11.11) Man-basket not permitted for height works.

**12 Hot Work (Welding / Gas cutting work)**

- 12.1) Only qualified welders should be employed at the work site. The CONTRACTOR should organise the qualifying test at site for his welders and the EMPLOYER / CONSULTANT should approve the welders. All welders should have to undergo qualifying test and only on passing the test, they should be allowed to work at site.
- 12.2) CONTRACTOR must organise for all welding work at site, Rectifier / Thyristor sets instead of AC transformer sets. AC transformer sets are banned for welding jobs (both open and closed top type).
- 12.3) CONTRACTOR should get his welding sets certified by the EMPLOYER/CONSULTANT before start of the work. These certificates should have to be renewed every month. A copy of the certificates should be displayed on respective welding sets.

ISSUE R4
-------------

SPEC.NO TCE.M4-917	<b>TATA CONSULTING ENGINEERS LIMITED</b>	SECTION: WRITE-UP
	<b>Safety Conditions for undertaking site work</b>	SHEET 11 OF 15

- 12.4) Only cables in good condition and insulated holders should be used. The length of supply cable to welding site should not exceed 8 metres and the welding set body should be properly earthed.
- 12.5) CONTRACTOR welder should not use a building structure, pipeline or railway track etc. as a return path of the current. Adequately rated circuit breaker should be provided in the power circuit for human protection on all power supply points.
- 12.6) Before starting any Hot work like Gas cutting, welding and grinding etc., the CONTRACTOR should obtain hot work permit from the EMPLOYER/CONSULTANT. The permit should be renewed on day-to-day basis.
- 12.7) CONTRACTOR should ensure purging of piping and equipment to make it totally safe before carrying out any hot work.
- 12.8) No combustible material should be stored on or near any source of heat like hot pipes, welding or gas. Before leaving the place of work or the CONTRACTOR's sheds, the CONTRACTOR's workmen should ensure that no material or item that could start a fire is left at site. Special attention should be paid to collection and disposal of oil soaked cotton waste or rags. On no account are these to be dropped into corners, pushed below equipment or left hanging on pipes.
- 12.9) CONTRACTOR must use gas cylinders in a safe manner. These should not be dropped from heights or dragged on the floor. Trolley with rubber rimmed wheels should be used for transporting gas cylinders within the site. All cylinders should be kept in upright position. Oxygen cylinders should not be kept near inflammable materials like oil etc.
- 12.10) Standard colour codes for the cylinder must be followed (Oxygen-Black, Acetylene-Maroon) by CONTRACTOR.
- 12.11) CONTRACTOR must provide the gas cutting sets with flash back arrestor at both ends (Cylinder and Torch) and gas cutting rubber tube ends fixed with the clamps.
- 12.12) CONTRACTOR must provide the fire blankets for fire protection and not tarpaulins in the vicinity of welding and gas cutting jobs.
- 12.13) CONTRACTOR must provide charged fire extinguisher of DCP / CO2 type with each welding/gas cutting set.

ISSUE R4
-------------

SPEC.NO TCE.M4-917	<b>TATA CONSULTING ENGINEERS LIMITED</b>	SECTION: WRITE-UP
	<b>Safety Conditions for undertaking site work</b>	SHEET 12 OF 15

12.14) LPG shall not be used for cutting / heat treatment purpose (strictly prohibited).

**13 ERECTION, LIFTING APPLIANCE AND GEAR**

13.1) CONTRACTOR shall submit detail erection methodology and shall get the same approved by EMPLOYER / CONSULTANT.

13.2) CONTRACTOR shall mobilize the lifting appliance and gear in good working condition.

13.3) CONTRACTOR shall submit a valid Test Certificate to the EMPLOYER / CONSULTANT, from approved certifying authorities for all of his lifting gear and hoists, slings, chains, wire ropes, hooks, chain-pulley blocks, winches, hoists and cranes etc. before commencing work.

13.4) These third party test shall be carried out at site by the CONTRACTOR

13.5) These certificates shall be available at site in the CONTRACTOR office for Inspection as and when required.

13.6) Full time mechanic shall be deployed to maintain all the lifting appliance and gear at site.

**14 CLEANLINESS**

CONTRACTOR must ensure cleanliness as an integral part of plant / project site outlook; the main obstacle to cleanliness in concrete batching plants, hot mix plants, grout mix plants, crushing plants, mine works, is the emission of fugitive dust. This must be fought by special care taken of the following:

- a) Material unloading & handling systems
- b) Equipments and workshops
- c) Unloading / Storage / handling of the materials
- d) Road systems.

It must be emphasized that the proper design and sizing of dust removal / extraction equipments is of utmost importance to ensure cleanliness; adequate & special care while designing & selection of machinery to be taken in the following dust prone areas:

- a) Cement Bag packing area.
- b) Cement Truck loading area.

ISSUE R4
-------------

SPEC.NO TCE.M4-917	<b>TATA CONSULTING ENGINEERS LIMITED</b>	SECTION: WRITE-UP
	<b>Safety Conditions for undertaking site work</b>	SHEET 13 OF 15

- c) Adequate sizing of all dust preventing, dust collecting and dust suppression / recovery devices.
- d) Proper design, positioning, use and maintenance of dust control equipment.
- e) Proper design, positioning and maintenance of storage bins like silos, bunkers, screw conveyors etc.

**15 MATERIAL HANDLING SYSTEMS**

CONTRACTOR shall have Material handling systems such as loading and unloading areas, conveyor belts and transfer points used to handle materials as raw meal, additives, solid fuels, clinker, and cement, these be equipped with dust removal devices. While designing the conveyor systems CONTRACTOR must take special care to minimize transfer points & provide dust suppression to control fugitive emission.

**16 EQUIPMENT AND WORKSHOP**

CONTRACTOR shall ensure that all dusty work areas such as cement bagging, truck/wagon loading, mixing or weigh hopper landing must be properly ventilated and filtered adequate care of dust suppression to be taken while designing.

Also important to allow for cleaning away dust produced by various types of equipment if they breakdown or are taken apart. This capacity of cleaning must be included in equipment design and selection criteria. It must also be accounted for when designing work-areas.

**17 STORAGE OF FINE MATERIALS**

CONTRACTOR should ensure that fine materials stored in silos, must be equipped with adequate dust filtering equipment. Storage of fine materials in the open air or open buildings is only accepted at exceptional locations. These storage zones must be protected from the dominant winds either by strategic positioning or through artificial protection (walls, barns). Areas where fine materials are stored in the open must be equipped or designed in such a way that potential runoff from rain/storm water does not contaminate the environment; this means that runoff waters must be collected and settled before release to off-site receiving bodies.

ISSUE R4
-------------

SPEC.NO TCE.M4-917	<b>TATA CONSULTING ENGINEERS LIMITED</b>	SECTION: WRITE-UP
	<b>Safety Conditions for undertaking site work</b>	SHEET 14 OF 15

**18 SCRAP AND REFUSE BINS-REMOVAL SYSTEM**

The CONTRACTOR shall ensure that he has sufficient waste bins that are identified for different wastes and maintained in clearly demarcated areas. Wastes with oily or other ignitable materials such as oily cotton wastes and hand gloves shall be stored separately with covers to prevent fires and shall be made of metal. Different wastes shall be segregated and stored separately and disposed off. These shall be emptied at routine intervals to prevent that they do not overflow with wastes.

**18.1) Solid Waste Management**

The CONTRACTOR shall ensure that he has sufficient waste collection bins categorised as hazardous and non-hazardous waste with specific names. Non-hazardous waste shall be disposed in environment friendly manner. CONTRACTOR shall maintain adequate records of hazardous waste disposed.

The waste collection bins should be covered properly.

**18.2) Vehicle Wash bay**

The CONTRACTOR shall establish a wash bay near each entrance to the project site. All trucks/vehicles moving outside the site shall have the tyres washed prior to the site leaving the project site. This is to ensure that the roads outside the site are not dirtied / defaced by construction muck. The wash bays shall have submersible pump (1+1 backup) and a hose jet along with recyclable water for washing tyres. Dedicated workers would be manning the wash back at each time. Dump trucks to have lift covers on top to prevent muck/dirt/smell from flowing across roads.

**18.3) Sedimentation tank**

The CONTRACTOR shall establish that the trade effluent generated as a result of maintenance of concrete batch mixing plant / grout mix plant or washing any residuals of tests conducted on concrete, be properly routed to a designed and approved sedimentation tank. The CONTRACTOR shall also periodically monitor and ensure the compliance to acceptable limits of the vital parameters of the treated water like pH, oil and chemical contents, BOD, COD, TDS, Turbidity etc or as prescribed under the conditions of consent to operate the plant before discharging.

ISSUE R4
-------------

SPEC.NO TCE.M4-917	<b>TATA CONSULTING ENGINEERS LIMITED</b>	SECTION: WRITE-UP
	<b>Safety Conditions for undertaking site work</b>	SHEET 15 OF 15

**19 PROTECTION OF WATER**

Both surface water and underground water resources must be protected from all possible pollution be it chronic or accidental.

**20 NOISE REDUCTION**

CONTRACTOR must ensure noise does not represent a nuisance to neighbours, all measures must be taken to reduce emission of noise from equipment (crushers and/or grinders must be enclosed, as well as compressors, diesel generators; care must be taken in selection of low-noise blowers). Noise reducing devices / acoustical enclosures must be installed systematically on the noisiest equipment. CONTRACTOR must follow the statutory legislation for noise levels. Timely preventive and break-down maintenance of the equipment and machinery shall be carried out by CONTRACTOR in order to reduce the noise generation.

**21 WASTE MINIMIZATION**

CONTRACTOR must avoid or minimize production of waste with an objective to aim towards zero-waste. Production facility must be provided with all the necessary equipment to manage its wastes; storage, sorting, cleaning, pre-processing, and recycling. Temporary waste storage facilities should be designed in such a way as to control emissions to the atmosphere (volatile organics, fugitive dust) and to protect surface and underground water.

**22 ASBESTOS**

22.1) Use of asbestos under any form is strictly forbidden in all construction activities and facilities.

22.2) Only CONTRACTOR trained in removal of asbestos should be eligible for asbestos removal. All removal work should be managed and approved by the EMPLOYER / CONSULTANT.

ISSUE R4
-------------

SPEC.NO TCE.M4-918	<b>TATA CONSULTING ENGINEERS LIMITED</b>	SECTION: WRITE-UP
	<b>Contractors Safety and Health programme</b>	SHEET 1 OF 23

**1.0 SAFETY ORGANISATION**

**1.1 SAFETY AND HEALTH POLICY**

The CONTRACTOR's organisation shall have a written SAFETY AND HEALTH POLICY issued by the Chief Executive of the organisation, appropriate to the scale and nature of the risks involved in the CONTRACT works. A copy of the policy shall be made available to the PURCHASER at the time of the award of the CONTRACT in evidence of the CONTRACTOR's commitment to management of employee's safety & health and compliance to statutory and regulatory requirements. The policy along with its component operation procedures shall be evidenced as working document publicized among the CONTRACTOR's and his SUB-CONTRACTORS' employees through appropriate languages. All the CONTRACTOR's employees shall be familiar with the policy and their role and obligations in its implementation. The policy shall meet the relevant statutory and regulatory requirements and other requirements of the PURCHASER/CONSULTANT. The policy shall periodically be reviewed for updating with respect to new and emerging legal and other requirements.

**1.2 SITE SPECIFIC SAFETY PLAN**

The CONTRACTOR shall make detailed Site-specific Safety Plan which should include the nature of work, time frame, work force involved, hazards and control measures and shall get the same approved by the Employer/consultant. Method statements shall be attached with Site Safety plan and the approved Safety Plan shall be displayed prominently in the Contractor's site office.

**1.3 SAFETY OFFICER:**

**1.3.1) SAFETY OFFICERS QUALIFICATION:**

A person shall not be eligible for appointment as Safety officer unless he

- (i) Possesses a recognized Degree in any branch of Engineering or Technology and had practical experience of working in industrial projects in a supervisory capacity for a period of not less than 3 years or possesses a recognised Diploma in any branch of engineering or technology and has had practical experience of working in industrial projects in a supervisory capacity for a period of not less than 5 year.

FILE NAME: TCE.M4-918-R3.docx

Proprietary rights of the information contained herein belong to Tata Consulting Engineers Limited (TCE). This information is intended to be used for the mentioned purpose/project only. In case of misuse of information and any claim arising thereof, cost and consequence will be on the party misusing the information.

ISSUE

R3

(ii) Possesses a recognised degree or Advanced diploma in industrial safety. (Approved by the EMPLOYER/CONSULTANT on the basis of his adequate Safety qualification [Advanced Diploma in Industrial Safety approved by State Board of Technical Education] and his/ her experience in safety field).

(iii) Has adequate knowledge of the language spoken by majority of construction workers from the construction site in which he is deployed.

1.3.2) The CONTRACTOR shall also nominate in writing competent Safety Appointees from various disciplines to assist the Safety Officer in implementation of safety measures in their routine contract works. The Safety Officer shall have sufficient authority to direct the CONTRACTOR's or his SUB- CONTRACTOR's personnel to meet Safety and Health requirements and to stop performance of work until such requirements are met.

**1.4 EMPLOYEE CONSULTATIONS,SAFETY COMMITTEE&COMMUNICATION**

1.4.1)The CONTRACTOR shall ensure full involvement of all his employees recognising their right to consultation on Safety, Health and Environment matters. The Safety officer shall be responsible for ensuring employees' involvement through routine Safety inspections, Hazard and Risk assessment in new and any changes in the work and their control. The CONTRACTOR shall maintain appropriate operating procedures to guide these requirements. The contractor shall plan, maintain and implement for entire Project duration, Training / matrix for regular SHE induction, job specific and specialized training programmes for all working levels.

1.4.2)The CONTRACTOR shall also appoint a Safety Committee comprising of the Safety Appointees from the various areas under the chairmanship of the Safety officer. Safety Officer shall report to Authority one level above the Contractor's Project In-charge. The committee should also include representatives of Sub-contractors. The committee shall meet minimum once in month to discuss the status and adequacy of the safety management, and any safety concerns of the employees. The committee shall also formulate and validate the safety procedures incorporating controls to prevent or mitigate hazards and risks before submission for approval by the EMPLOYER/CONSULTANT. Safety Officer shall maintain the records of the meetings and minutes of the Safety Committee meeting shall be submitted to the Employer/CONSULTANT.

1.4.3)The CONTRACTOR shall communicate to the employees regularly on job hazards applicable to their tasks in hand and hazards present on Project site. The Safety Appointees shall hold 'Toolbox Talks' or pep talks for this purpose on a routine basis before undertaking any safety critical and/or non-routine activities. Weekly meetings of the CONTRACTOR and his SUB-

ISSUE  
R3



CONTRACTORS attended by the Safety Officer and the Safety Appointee shall include safety as a key item in the agenda to discuss hazards and risk assessments, job safety analysis and control procedures and to review accidents and incidents (Near-miss) for remedial measures to prevent reoccurrence. The minutes of the meeting shall be submitted to the EMPLOYER/CONSULTANT. The Safety Officer shall maintain the records.

**1.5 Insurance. Statutory Requirements:**

1.5.1) CONTRACTOR should obtain Contract Labour License from Inspector of labour/Inspector of factories as per Contract labour act 1970.

1.5.2) All the Contractor's workmen should be covered by Site Specific Workmen compensation insurance or Group Workmen compensation insurance with site name endorsed for the project duration (Workmen Compensation Act 1923) or should cover under ESI (If the project location is in ESI Zone).

1.5.3) All the Contractor's workmen should be covered under EPF (Employee Provident Fund Act 1952).

1.5.4) All CONTRACTORS should comply with local statutory requirement:

- (i) Building and other Construction workers Act, 1996.
- (ii) Environmental protection Act, 1986.
- (iii) Factories Act, 1948.
- (iv) Indian Electricity Act, 2003.
- (v) Indian Boilers Act, 1923.
- (vi) Petroleum Act, 2002.

1.5.5) CONTRACTOR shall obtain CAR Policy / ESIC policy for the entire project value / duration.

1.5.6) **Other Statutory requirements:**

- (i) Electrical Equipment's, Scaffold materials, Gas cylinders, mechanical equipment and machineries which are deployed at site are as per IS code.
- (ii) Storage of combustible materials inside the project premises must be as per the allowable limits mentioned in the Petroleum act/Gas cylinder storage act.
- (iii) PPE's must be as per IS standard.

ISSUE

R3

(iv) CONTRACTOR is accountable for any statutory violations observed by the enforcement/inspecting govt authorities.

(v) In case of accidents, inside the project premises, the accountability lies with the CONTRACTOR.

**1.6 CONTRACTOR'S MONTHLY SAFETY REPORTS**

1.6.1) CONTRACTOR shall submit a monthly written report to the EMPLOYER/CONSULTANT, which shall be due on the fifth workday of every month. The Safety and health of all full time, part-time, permanent, temporary, contract employees and any outsourced employee undertaking any part of the CONTRACT works shall be included in the safety report. The report shall include the total number of working hours for the month, the number of recordable accidents and the number of lost-time injury /accidents. A cumulative trend plot of the monthly severity and frequency rate of the reportable incidents/ accidents shall be included in the Monthly safety report.

1.6.2) CONTRACTOR shall arrange to display the safety statistics and the cumulative plot of severity and frequency of accidents mentioned above painted on a board prominently displayed, as a means of encouragement and assurance to all interested parties and for publicising the safety achievements.

**1.7 CONTRACTOR'S ACCIDENT/INCIDENT REPORTS/PENALTY SYSTEM**

1.7.1) CONTRACTOR shall report orally, to the EMPLOYER/CONSULTANT regardless of their extent, duration and severity, immediately on occurrence of all incidents/accidents resulting in:

- (a) Personal injury / Dangerous Occurrences
- (b) Property damage
- (c) Near misses

1.7.2) CONTRACTOR shall submit the accident / incident report in writing to the EMPLOYER/CONSULTANT within 24 hours of its happening in the form as prescribed by the governing statute or in the absence of which, in the form prescribed by the EMPLOYER/CONSULTANT. The CONTRACTOR shall detail in the 'Accident / Incident Report', the particulars of the dangerous occurrence leading to the accident, lost time of absence due to accident, root cause analysis and the corrective and preventive actions to prevent such recurrence. In addition, the CONTRACTOR shall include his estimate of the impact of accident on project schedule. Incident including near miss cases shall also be reported in the same manner identifying root cause(s) to eliminate such potential occurrence or risks. The CONTRACTOR shall ensure that corrective & preventive action is

taken so that recurrence of the accident / incidents at one location on site shall not take place at other locations/sites.

1.7.3) Penalty clauses applicable to contractor/ sub contractor against non-compliance of SHE norms, requirements, terms, clauses and instructions given by employer / consultant / applicable statutory laws & requirements.

**1.8 FIRST-AID PERSONNEL AND FACILITIES**

1.8.1) CONTRACTOR shall ensure first-aiders (person who is well trained and can administer first aid) are available on site. The Contractor shall ensure that adequate numbers of first-aid boxes and or first- aid stations as per statutory requirements. The persons holding current certificates of competency of recognised institutions in prescribed numbers as per any governing statute. First-aiders' names shall be prominently displayed.

1.8.2) The First-aid boxes shall display contents of medical and medicinal articles with quantity maintained, which shall be in accordance with governing statute. Nominated first-aider shall replenish stock of first aid boxes promptly.

**1.9 OCCUPATIONAL HEALTH CENTRE**

1.9.1) CONTRACTOR should establish and maintain an Occupational Health Centre. (In case, Where the CONTRACTOR out-sources such facility, it shall meet the statutory requirements and shall be approved by the EMPLOYER /CONSULTANT and the statutory body).

1.9.2) Occupational Health Centre shall be served by a full time medical officer holding a medical degree in allopathic medicine with a minimum of five years experience in Occupational Health/Medicine. A male nurse, one dresser/compounder and one sweeper-cum-ward boy who will all be available during working hours.

1.9.3) Occupational Health Centre shall be capable of undertaking emergency care services or emergency treatment facilities which shall include emergency life saving aids and appliances to handle head and spinal injuries, severe fractures, snake bites, burns of all nature, electric shocks, cases of asphyxiation and such other severe injuries as could be reasonably anticipated at the facilities and shall meet provisions of any governing statute.

1.9.4) AMBULANCE ROOM AND AMBULANCE VANS: The CONTRACTOR shall arrange for an ambulance room and an ambulance van directly or outsource the facilities meeting the governing statutory needs for prompt transportation of

ISSUE  
R3

serious cases of accident and or sickness to the hospital. Such facilities shall be maintained in good repair and equipped with facilities such as dry powder type extinguishers, flashlights, portable oxygen unit, self-contained breathing apparatus etc. as prescribed by the governing statute. Ambulance van shall be available round the clock.

**1.10 INDUCTION AND JOB-SAFETY TRAINING**

1.10.1) The CONTRACTOR shall maintain a procedure for identification of the training needs and training his employees to create a Safety and Health conscious work-force that will comply with the law and safety requirements of the organisation. He shall also maintain a procedure for safety induction and initial training as well as follow-up training on the job safety for new entrants. All employees shall receive effective training and periodic refresher training on the operation control procedures specific to their tasks designed to control the job-safety risks. A booklet of such operation control procedures and safety rules with need based pictorial illustrations shall be made available to all employees who are to learn and be familiar with such procedures. All training shall be monitored for effectiveness as per established procedures. The CONTRACTOR shall maintain records of all such training.

**The induction program shall include the following:**

- i) Site Safety and Health policy
- ii) Site entry and access.
- iii) Standard conditions of work in the site.
- iv) Site layout and arrangements such as rest rooms, storage and facilities.
- v) Emergency response procedures and escape routes.
- vi) Incident and near miss reporting.
- vii) Medical and welfare facilities.
- viii) Details of Work permit.

1.10.2) The safety officer shall conduct regular fortnightly or monthly mock-safety drills for different imaginary accident scenarios, in premeditated work areas to provide on-job training such as:

- i) Use of safety appliances such as water monitors, fire hydrants, fire hydrant pumps, fire-hoses, extinguishers, breathing apparatus and safety harness for working at height,
- ii) Response to health and safety emergencies,
- iii) Fighting fires using various equipment and
- iv) First-aid

1.10.3) Participants shall receive training during mock-drills through role-play of their normal expected tasks during emergencies and fire fighting. The degree of

ISSUE
R3

demonstrated ability in the chosen tasks during such safety drills shall be recorded as participants' competence level for planning his further training.

1.10.4) The Safety officer shall be trained on a standardised comprehensive advanced training programme covering safety management, legal aspects, techniques of Hazard identification and Risk assessment and specific Job- safety in various disciplines such as Civil, Electrical, Instrumentation and Mechanical plant and equipment of the CONTRACTOR. The training records shall be maintained subject to audit by the EMPLOYER/CONSULTANT. Training effectiveness shall be assessed and recorded and used as input for further training plans of the employee.

**1.11 SAFETY PROMOTION**

Safety Posters, Banners and Slogans displayed for safety promotion shall be rotated at frequent intervals at the site locations. The CONTRACTOR is encouraged to have safety promotion as an item in the Safety Committee agenda. The CONTRACTOR is encouraged to include safety promotion programmes such as: safety competitions in slogan and poetry writing on safety, screening of safety films, celebration of National safety and Environmental day, safety suggestion schemes and safety library etc.

**1.12 PURCHASE AND PROCUREMENT CONTROL**

1.12.1) CONTRACTOR shall maintain a procedure for control of his purchases to ensure that all safety requirements are appropriately vetted by the safety personnel during all stages of procurement including planning of specifications, inspection for acceptance and commissioning in order that threats to safety are not overlooked and appropriate attention is paid to the training of personnel in the operation of the Contractor's new or changed machinery and their Operation & control procedures, to prevent/control risks.

1.12.2) CONTRACTOR shall exercise due diligence in appointing his SUB-CONTRACTORS and outsourcing contract services, that no new safety or Health threats are created. The CONTRACTOR shall ensure personnel of SUB-CONTRACTORS and outsourced contract services are competent in Safety, Health and Environmental management to meet the POLICY requirements. They shall be made aware of the safety rules, emergency procedures and any information that will have a bearing on the safety, health and related contractual obligations.

**1.13 HAZARD IDENTIFICATION AND RISK ASSESSMENT (HIRA)**

ISSUE

R3

1.13.1) CONTRACTOR shall ensure that his key personnel and safety personnel are trained to be competent in Hazard identification, Risk assessment and risk control processes. The CONTRACTOR shall on a routine basis identify, evaluate and control all safety & health risks especially in the hazardous work activities and also to validate the previous risk assessments. Elements such as hazard identification, evaluation of risks with existing control measures in place and estimate of tolerability of the residual risks shall be an ongoing process. Any additional/new control measures shall be designed based on this process on need basis.

1.13.2) CONTRACTOR shall maintain a Hazard Identification, Risk Analysis and Control Manual (HIRAC) pertaining to all his activities duly updated as detailed above. The HIRAC for activities shall be made available to the EMPLOYER/CONSULTANT during regular inspections and audits.

**1.14 WORK PERMITS**

The CONTRACTOR shall maintain a work permit procedure. Essential features of the work permit system are as follows:

1.14.1) Clear identification of who may authorize particular jobs and who is responsible for specifying the necessary safety precautions.

1.14.2) Communication of instructions on the issue and use of permits.

1.14.3) Monitoring and auditing to ensure that the system works as intended.

1.14.4) The types of jobs requiring the control of a work permit are:

- (i) Hot work of any type (e.g. Hot metal riveting, gas cutting, brazing, grinding, gouging, gas and electric welding) and Work which may cause uncontrolled hydrocarbon release, including any disconnection or opening of a closed pipeline, vessel or equipment containing flammable material.
- (ii) Work at height above 1.2m / 4ft or those works at unprotected elevations that demands fall protection to prevent from falling or involving danger of dropped objects.
- (iii) Work involving electrical isolation or work on live electrical systems and equipment.
- (iv) Work involving the use of dangerous substance (Radioactive materials).
- (v) Demolitions and Excavations.
- (vi) Pressure testing.
- (vii) Maintenance operations.
- (viii) Entry into confined spaces.

The work permit issued under the procedure shall be valid for a specified period and shall be issued only after all safety precautions are fulfilled and duly

ISSUE
R3

verified by the concerned department engineer and safety officer (EMPLOYER/CONSULTANT).If deemed necessary the same work permit sheet may be revalidated to extent beyond the specified period provided the site conditions and the persons on job remain the same.

**1.15 Job Safety Inspection:**

1.15.1) Employer/Consultant will conduct planned inspections of the contractors work area and activities. The inspections will verify the contractor`s safety records. The Contractor safety inspection will cover the safe behaviour of contractor employees, safe work condition of equipment in use and the safety and housekeeping of area where work is carried out.

1.15.2) Contractor also shall maintain a procedure for safety inspection at routine intervals to provide assurance that the instituted safety procedures are in place to prevent deviations from established standards that could lead to a safety hazard and consequential risk. The Contractor shall establish appropriate standardised checklist for systematic job safety verification to ensure

- i) Set standard are followed without deviation.
- ii) Employees are competent to perform as prescribed operational control procedure.
- iii) Monitoring of safety of the various work areas/tasks.
- iv) Adequacy of existing operation reports and proposed remedial measures shall be submitted to the employers/Consultant.

**1.16 Safety Audits**

1.16.1) The Employer/Consultant shall retain their rights to audit the contractor`s safety management system either directly by their employees or his nominated representatives for its effectiveness.

1.16.2) The contractor shall undertake periodic safety audits to confirm through investigative methods the effectiveness of the measures set out in policy. In order to be effective such safety audit shall be comprehensively covering all aspects detailed in the specification to ensure effective loss-control/accident prevention programme. Safety audits shall take into account the safety inspection records, remedial measures and effectiveness of the safety programme shall be based on the contractor`s effective hazard identification and risk assessment processes for design of operational control procedures and on the safety statistics. Audit reports and preventive actions and safety improvement programmes shall be submitted to the Employer/Consultant.

ISSUE
R3

**2.0 EQUIPMENT, SUBSTANCES AND PERSONAL SAFEGUARDING**

**2.1 MECHANICAL SAFETY**

2.1.1) The CONTRACTOR shall ensure that all his equipments and machinery are safe to use while in motion or working. Operators shall have received training or instruction on operation of the machinery and the regulatory requirements. The CONTRACTOR shall have adequate procedure to ensure the stability and securing of his working machinery during operation. He shall restrict repair and maintenance of the machinery to trained personnel and maintain records of repairs and maintenance. The equipment shall have appropriately designed means of isolating from sources of energy and shall have emergency stop control, which is easily accessible. All controls shall be clearly and uniformly marked. All operation controls, interlocks, sensing devices and guards on tools and equipment shall be functional and their status shall be regularly checked and recorded. The CONTRACTOR shall provide evidence of compliance to these requirements in any contractual write-ups submitted to the EMPLOYER/CONSULTANT for approval in respect of critical construction/contract works.

2.1.2) The CONTRACTOR shall provide only good quality Hand tools and ensure control of condition, storage, routine inspection and use of such hand-tools. Unsafe tools such as with cracked or broken handles, mushroomed chisels and punches, worn screwdrivers, hardened hammer heads; power tools with unsafe resistance to earth or without safety guards shall be strictly prohibited.

2.1.3) All safety ladders, scaffolding and such access equipment shall meet requirements of IS 3696 and IS 4014:1967 and such standards as the EMPLOYER/CONSULTANT may stipulate. The safety work permits shall be issued only after ensuring that all safety requirements of access equipment are complied with. Access equipment shall be inspected on a routine basis to prevent injuries caused by falls. It shall be the responsibility of the Contractor to provide safe work access to all work places.

2.1.4) The CONTRACTOR shall ensure safety of all those concerned with lifting and those who may be affected by material hoisting, lifting and handling using various mechanical aids. All lifting equipment such as cranes, hoists, lifting tools and tackles, shackles, hooks chains and links shall be designed as per appropriate international codes of construction. Operators shall have been trained in operation and maintenance of such equipment besides training on standard hand signals to be employed during the hoisting and lifting operations. Safe Working Loads (SWL) shall be marked on equipment prominently. SWL shall be evidenced to have been established by test procedures in accordance with acceptable codes of practices. Medical Examination of Operator & Signaller is mandatory.

ISSUE

R3



SPEC.NO TCE.M4-918	<b>TATA CONSULTING ENGINEERS LIMITED</b>	SECTION:WRITE-UP
	<b>Contractors Safety and Health programme</b>	SHEET 11 OF 23

- 2.1.5) Riding on construction equipment, forklifts and cranes shall be prohibited unless such vehicles are provided with passenger seats.
- 2.1.6) Pressurized gas and air systems shall be maintained safe in good working order and shall meet the requirements of the Factories Act 1948, The Static and Mobile Pressure Vessels Rules 1984 and the Gas Cylinder Rules 1934 as applicable. The safety relief valves, safety appurtenances and isolation systems shall be compliant with safety code of practices. Any statutory register of pressure vessel records and the code of practices shall be subject to periodic auditing by the EMPLOYER/CONSULTANT. The CONTRACTOR shall ensure the pressurized gas and air systems are periodically tested by competent authority and records are maintained properly.
- 2.1.7) The areas of highly dangerous activities like hoisting, lifting and rock blasting, and radiation, shall be appropriately barricaded to protect personnel and machinery and guided by work permit discipline. Emergency plans shall cater to emergencies arising out of such activities.
- 2.1.8) Signs, barricades, barrier tapes and warning or entry restriction devices or accessories shall be provided to minimise work related risks of accidents and injuries. Signage shall meet all regulatory requirements such as under The Building and Other Construction Workers Act, 1996; Factory Act, 1948; Manufacture, Storage and Import of Hazardous Chemicals Rules under Environmental Protection Act 1986; Indian Explosives Act 1984 and Gas Cylinder Rules, 1981 and Indian Electricity Act, 1910 and Rules there of and any other safety requirements of the EMPLOYER/CONSULTANT.
- 2.1.9) CONTRACTOR shall follow the Environment Act 1986 and Rules framed there under. Devise and adopt appropriate noise control measure to maintain noise level at site reasonably below the acceptable statutory noise levels. Work area monitoring & Ambient Air monitoring for various parameters [i.e. Noise, Dust Water, SPM, SO<sub>2</sub>, NO<sub>2</sub> etc.] to be checked through approved laboratory.

**2.2 ELECTRICAL SAFETY**

- 2.2.1) CONTRACTOR shall provide only such equipment for work that is electrically Safe to work. The CONTRACTOR shall have a procedure to identify and record all his electrical equipment in a register, with provisions to record his periodic inspections of such equipment. Inspection shall cover cables, extension leads, all electrical equipment drawing power from socket outlet. He shall identify and maintain in good working order all electrical installations such as distribution panels and major switchgear ensuring safe accessibility. A clear area shall be maintained around panels and switchgears. The installed equipment shall be periodically inspected by qualified personnel to ensure their continued safe operating condition. Inspection shall include earth polarity

ISSUE
R3

SPEC.NO TCE.M4-918	<b>TATA CONSULTING ENGINEERS LIMITED</b>	SECTION:WRITE-UP
	<b>Contractors Safety and Health programme</b>	SHEET 12 OF 23

checks, continuity checks and earth resistance checks. The CONTRACTOR shall ensure use of flameproof and explosion proof switchgears and lighting fittings where required as per governing codes.

2.2.2) Approved earth leakage relays or alternative safety devices to relevant are and International codes shall be used on all portable electrical hand tools. Where possible low-voltage electric power supply shall be used for hand tools, earth leakage units shall protect electrical installations in workshops, kitchens, cafeterias, first-aid rooms, laboratories and offices. Record of regular checks shall be maintained. The CONTRACTOR shall comply with 'Code of Practice for Earthing as per IS: 3043.

2.2.3) Safety rubber matting of appropriate voltage rating conforming to IS 5424 entitled 'Rubber Mats for Electrical Purposes' shall be provided in front of all switchgears and power distribution panels for the safety of personnel operating such equipment.

2.2.4) CONTRACTOR shall arrange displaying signage under Indian Electricity Act 1910, such as:

(i) Danger notices as per IS 2551 in conspicuous places on all Low, Medium and High voltages as per Rule 35,

(ii) Instruction of restoration of persons suffering from electric shock in English and local languages as per Rule 44 in switchgear rooms, substations and places where electricity is used and

(iii) Notice prohibiting unauthorized entry in areas where electrical apparatus are used.

2.2.6) All power cables providing construction power to various construction machinery and the connectors shall be in safe and sound condition. Cables shall be routed through cable trays supported on appropriately designed structures, duly clamped, secured and identified. Road crossing cables shall be laid in conduits buried at least 600 mm below the surface to prevent damage due to vehicular traffic. All cables shall be off the floor to avoid damage or tripping hazard. Cables shall be terminated at the switchgear and sockets in a workman like manner to prevent loose contacts and flashover. Only safety receptacles shall be used for providing power connection to hand-tools. All switches and distribution boards shall be clearly marked. All electrical distribution and panel wiring diagrams shall be available with the electrical maintenance personnel. The CONTRACTOR shall maintain a safe electrical isolation/Lockout – Tagout (LOTO) procedure.

ISSUE
R3

2.2.7) The CONTRACTOR shall ensure lighting circuits are not used for hand-tools. No electrical equipment shall be overloaded. Tools and test equipment used on electrical systems shall be insulated.

**2.3 SUBSTANCES ABUSE PROGRAMME**

2.3.1) The CONTRACTOR is encouraged to have a 'Substance Abuse Programme'. Drinking during working hours shall be strictly prohibited. The CONTRACTOR shall promote through poster and other publicity, awareness on abuse of substances such as alcohol and such depressant drugs that slows the activity of brain and spinal cord on abusive usage endangering the safety and health of users and others affected by their work.

2.3.2) No tobacco in any form shall be allowed in EMPLOYER project premises.

**2.4 HAZARDOUS SUBSTANCES CONTROL**

2.4.1) CONTRACTOR shall prevent all injuries, illnesses and damage to property or the environment caused by any article or substance, which proves to be hazardous. The code of practices of construction and operation and maintenance and control procedures shall meet required statutory and regulatory requirements. Personnel shall be trained on use, handling, storage, disposal and emergency spillage procedures.

2.4.2) CONTRACTOR shall detail and deploy operational controls to reduce hazardous wastes and their disposal as required by the statute 'Hazardous Waste (Management and Handling) Rules 2000'. Oil wastes, used oils, soil and cotton soaked in oil consequent to handling operations, grease and many class of paints and asbestos sheets and gaskets are typical hazardous wastes.

2.4.3) CONTRACTOR shall identify, contain and control all sources of radiation. Appropriate regulatory approvals shall be obtained before commencement of work involving radiation sources. Radiation protection advisors suitably qualified and experienced shall be appointed whose names shall be submitted to EMPLOYER/CONSULTANT. Surveillance of personnel engaged in such work shall be maintained in accordance with regulatory requirements.

2.4.4) CONTRACTOR shall prominently display Material Safety Data Sheets (MSDS) of all chemical, and hazardous substance used, handled, stored on site, and should ensure that these MSDS are available for reference to all employees at all times and displayed at site ( preferably in local language) understandable by the workmen / labour.

ISSUE  
R3

SPEC.NO TCE.M4-918	<b>TATA CONSULTING ENGINEERS LIMITED</b>	SECTION:WRITE-UP
	<b>Contractors Safety and Health programme</b>	SHEET 14 OF 23

**3.0 PERSONAL SAFEGUARDING**

**3.1) PERSONAL PROTECTION EQUIPMENT (PPE)-General**

The CONTRACTOR shall provide his employees required PPE meeting the requirements of the stated IS specifications and guidelines or equivalent International Standards as may be prescribed by the EMPLOYER / CONSULTANT from time to time. The CONTRACTOR shall have instituted good working procedures and practices in providing PPEs, maintenance, issue and training on their usages. All PPE shall be periodically checked to ensure worn, damaged equipment are replaced expeditiously.

**3.1.1) Control Issue, Use and Maintenance of the PPE**

Employees shall be responsible for the PPE issued to them. The CONTRACTOR shall meet requirements of IS 8519 entitled 'Guide for Selection of Industrial Safety Equipment for Body Protection' or any equivalent international specification that the PURCHASER/CONSULTANT may prescribe.

**3.1.2) Head Protection**

CONTRACTOR shall comply with requirements of IS 2925. Hard hats with chin strip shall be used and worn. Hard hats intended for use by visitors shall have replaceable paper lining.

**3.1.3) Eye and Face Protection**

Eye protection shall be worn during all operations by operators and people in the vicinity, where there is a danger of flying particles of metal such as generated during use of hand tools such as chisels, grinding, welding and cutting - lathe work on brass and cast iron, acid and alkali splash, high pressure jet cleaning or insulation removal from heights using high pressure jets. The CONTRACTOR shall meet the requirements of IS 8520 entitled 'Guide for Selection of Industrial Safety Equipment for Eye, Face and Ear Protection'.

**3.1.4) Footwear**

Safety shoes, boots and gumboots fitted with steel toe-caps of approved quality conforming to prescribed Indian or international standards. Wearing of unsafe safety shoes such as jogging shoes, tennis shoes, slippers and sandal etc. are prohibited. The CONTRACTOR shall meet the requirements of IS 10667 entitled 'Guide for Selection of Industrial Safety Equipment for Protection of Foot and Leg'.

ISSUE
R3

SPEC.NO TCE.M4-918	<b>TATA CONSULTING ENGINEERS LIMITED</b>	SECTION:WRITE-UP
	<b>Contractors Safety and Health programme</b>	SHEET 15 OF 23

**3.1.5) Protective Clothing**

CONTRACTOR shall prevent hazards of loose clothes worn by workmen getting caught in moving machine parts. Loose and thin garments such as dhoti and pyjamas are prohibited. While the CONTRACTOR shall ensure that all workmen wear long sleeved shirts, jackets or the like with the sleeves rolled down and secured at the cuff, long pants/ trousers extending upto the top of the safety shoes so as to prevent injuries caused by contact with heat, cold abrasive and sharp surfaces shall be strictly enforced. Such protective clothing shall be mandatory in hazardous areas especially during start-up operations involving hot, inflammable, and other chemical hazards, furnaces and boilers and such fired equipment and asphaltting plants. Personnel exposed to acids and alkalis hot fluids and steam during such operations shall be provided with appropriate heat or corrosion resistant clothing. The CONTRACTOR shall meet the requirements of IS 8990 entitled 'Maintenance and Care of Industrial Safety Clothing'.

**3.1.6) Hand Protection**

CONTRACTOR shall provide appropriate hand gloves as per IS 8807 entitled 'Guide for Selection of Industrial Safety Equipment for Protection of Arms and Hands' to prevent injuries to hands during work. The CONTRACTOR shall maintain appropriate inventory of gloves for different applications like acid and alkali handling, general-purpose work gloves and asbestos or heat resistant hand gloves etc.

**3.1.7) Safety Harness**

CONTRACTOR shall provide Full body Safety harness with double lanyard to workmen engaged for work in heights such as open-sided floors, open-sided scaffoldings, floor and roof openings, overhead construction works of various nature etc. where there is a falling hazard of two meters or above. Storage, issue, wearing and maintenance of full body safety harness with double lanyard shall be under strict supervision and records shall be maintained. Practices for safety harnesses and fall arrests shall conform to IS 4912, IS 11972 and IS 8519 or equivalent international codes.

**3.1.8) Falling Object Protection**

Where work is in progress in elevated areas, barricades, barrier tapes, signs and such entry restriction devices shall be used to keep area below clear of personnel to prevent injury due to falling objects. If work is required in the area below elevated work area, it shall be scheduled at a time different from elevated works. The workmen below shall be protected from falling objects by the debris net or a catch platform with an adequate toe board to prevent material from falling off. Use of safety net for elevated works shall be considered in the work-permits where appropriate. Where a lift is made above

ISSUE
R3

a working area, the area below the path of the lift shall be cleared of personnel during the lift and barricaded and guarded to prevent entry of persons generally in conformity with IS 4912, IS 11972 and IS 13416 for protective barriers in and around building and preventive measures against safety hazards in work places and safety requirements for floor and wall opening, railings and toe- boards.

**3.1.9) Respiratory Equipment**

CONTRACTOR shall maintain where appropriate, procedures for training and use of Self-Contained Breathing Apparatus (SCBA). The SCBA shall be provided together with lifelines and rescue teams to safeguard personnel working in areas where gases such as carbon monoxide, methane chlorine and such life endangering atmospheres are present. The CONTRACTOR shall meet requirements of IS 9623 for 'Selection, Use and Maintenance of Respiratory Protective Devices'. The CONTRACTOR shall have trained adequate number of personnel including the identified fire fighting teams, hose teams and SAs in the use of the SCBA. The CONTRACTOR shall use the periodic safety drills to demonstrate, train and establish competence of personnel in the use of SCBA.

**3.1.10) Hearing Conservation**

CONTRACTOR shall ensure reasonable precautions are taken to avoid injury to the hearing of the employees. All noise levels shall be controlled within 85 dBA. The CONTRACTOR shall identify noise areas and display caution boards in such noise areas where noise levels exceed prescribed safe level, the CONTRACTOR shall arrange for appropriate engineering control measures to minimise the noise level in such high noise level areas. Where this is not feasible, appropriate earmuffs or ear protectors (ear plugs) shall be provided to workmen ensuring these are worn by those exposed to noise levels beyond safe levels. Periodic hearing acuity tests shall be conducted on such persons exposed to high noise levels to ensure that they do not suffer any hearing impairment as per requirements of IS 8520:1977, The contractor shall also maintain records of such medical tests. The CONTRACTOR shall devise training programme for awareness on effects of high noise hazards and control measures for all the employees.

**3.2) MANUAL MATERIAL HANDLING AND ERGONOMICS**

3.2.1) CONTRACTOR shall have procedures to identify risks involved in manual / material handling operation and tasks. The CONTRACTOR shall ensure

ISSUE
R3

appropriate training to prevent any possible injury. Full use of mechanical aids shall be made to avoid risks arising out of such manual handling. Employees shall be adequately trained on such manual tasks and related safety precautions to reduce the risk of injury to personnel engaged in such work.

3.2.2) CONTRACTOR shall undertake ergonomic study of manual operations to prevent musculoskeletal injury during manual handling, besides visual fatigue and mental stress giving considerations to matters such as seating, lighting and ventilation, etc.

**4.1) FIRE PROTECTION AND PREVENTION**

4.1.1) CONTRACTOR shall arrange to train his personnel meeting the prescribed qualifying competence needs, in requisite numbers in the operation of such fire protection equipment and systems.

4.1.2) Risk assessments shall be carried out to identify potentially vulnerable areas to provide sufficient quantities of correct type of extinguishers and ancillary equipment to deal with various types of fire hazards.

4.1.3) Where required under the CONTRACT the CONTRACTOR shall provide appropriate type of extinguishers close to areas of fire hazard but not too close they are cut off from use during a fire. Water based extinguishers shall not be positioned close to or used on electrical equipment.

4.1.4) Extinguishers shall be marked / labeled and recorded with location particulars in a register. These shall be inspected at monthly intervals to ensure they are in operable sound condition. There shall be a systematic plan for servicing, repairing and recharging fire extinguishers and for recording such dates on the register and equipment.

4.1.5) The location of fire fighting equipment shall quickly and easily be identifiable especially in emergencies in a conspicuous manner painted as high as possible to identify the location of the extinguisher to prevent it from being obscured by machinery and goods stacked in front and to return the equipment to its location after emergency use in other locations. In order to ensure this, 'Keep Clear' area shall be demarcated and maintained. Location plans of extinguishers and fire-fighting equipment shall be prominently displayed when desired by the EMPLOYER/CONSULTANT.

ISSUE

R3

SPEC.NO TCE.M4-918	<b>TATA CONSULTING ENGINEERS LIMITED</b>	SECTION:WRITE-UP
	<b>Contractors Safety and Health programme</b>	SHEET 18 OF 23

- 4.1.6) Safety Officer / Security shall be trained on fire fighting techniques who shall co-ordinate and control Fire protection and prevention programmes.
- 4.1.7) Where required under the CONTRACT, the CONTRACTOR shall maintain alarm systems powered by mains and by battery for back-up. Where required under the CONTRACT, emergency lighting shall be provided to aid evacuation in poor lighting conditions following the alarm. The alarm system shall be made known to all employees. When the EMPLOYER extends these facilities for use by the CONTRACTOR, he shall provide appropriate training to his personnel in the use of such emergency facilities and duties.
- 4.1.8) A clear written procedure for action in the event of fire should be produced. Fire teams and hose teams shall be identified and their responsibilities during emergencies shall be detailed in writing. Personnel shall be trained on their fire duties and use of fire-fighting equipment. Regular drills shall be conducted to test procedures and to validate them. Fire instructions and emergency procedures shall be displayed throughout the premises. Emergency response procedures are detailed under para 5.0 below.
- 4.1.9) A means of escape shall be provided in all work areas and storages and maintained and kept free from obstruction. All exits shall be clearly marked and kept unlocked whilst the premises are in use. Escape routes shall be protected from fire.
- 4.1.10) When a hot work permit is issued, the CONTRACTOR shall ensure:
- (i) Identification of combustibles such as paper, cardboard and wood and moving away from area where hot work is undertaken using open flame or electric arc.
  - (ii) Determination that flammable vapours and liquids are not present.
  - (iii) Protection of floor and wall openings to keep out sparks.
  - (iv) Determination that sprinkler hydrant and other installed fire fighting systems are functional.
  - (v) Establishing a fire-watch with fully loaded extinguishers or charged Water-hoses throughout the operation and 30 minutes after completion of operation
  - (vi) Adequate ventilation for welders, by means of natural air movement  
Local exhaust ventilators or air-line respirators as required.
  - (vii) Workmen performing the task are adequately briefed on job safety analysis, hazards and risks and the safeguards against risks.

**4.2) SECURITY**

- 4.2.1) Where required under the contract, security personnel shall do all that is reasonably practicable to ensure the safety of employees and property of the company in the face of accidents by fighting fires and containing losses due to pilferage, theft, vandalism and industrial espionage both by employees and external elements. Security personnel shall be appropriately competent and receive adequate safety training. Security personnel shall routinely report on a

ISSUE
R3



SPEC.NO TCE.M4-918	<b>TATA CONSULTING ENGINEERS LIMITED</b>	SECTION:WRITE-UP
	<b>Contractors Safety and Health programme</b>	SHEET 19 OF 23

standardized basis on aspects such as violation of fire-protection rules, use of alcohol and narcotic drugs, condition of security fencing, floodlighting and storages etc.

4.2.2) Where the project is located where a number of other companies are in operation, the CONTRACTOR shall plan for mutual assistance /off site programmes in cases of emergencies, as are practiced in the area in conjunction with the EMPLOYER.

4.2.3) Where common boundaries exist between companies, the CONTRACTOR in conjunction with the EMPLOYER shall co-ordinate security control over factors common: such as floodlights, fencing, pipelines containing gas, fuel and electricity.

4.2.4) Security personnel shall be represented in the Safety Committee through the Safety Appointees nominated from the area.

**5.0) EMERGENCY PLANNING / EMERGENCY RESPONSE**

5.1) CONTRACTOR shall plan to deal with on site emergencies. An emergency planning/emergency response specific to the job site shall be written and communicated to all employees. The emergency planning/emergency response shall identify for the potential for and responses to incidents and emergency situations and for preventing and mitigating the likely illness and injury that may be associated with them.

5.2) CONTRACTOR shall review his emergency preparedness and response plans and procedures in particular after occurrence of incidents or emergency operations.

5.3) CONTRACTOR shall designate his emergency team with their duties during emergencies defined, including those of the hose teams, medical personnel, first-aiders and security. The CONTRACTOR shall maintain a procedure as to how his emergency organization shall liaise with the EMPLOYER/CONSULTANT representatives in the emergency planning/emergency response.

5.4) CONTRACTOR shall also periodically test such emergency procedures by conducting mock-drills and use the experience for updating the emergency planning/emergency response and for training the employees on the perceived competence needs.

5.5) The Emergency Planning/Emergency Response of the CONTRACTOR shall be under the control of the Safety Representative who shall be able to co-

ISSUE
R3

SPEC.NO TCE.M4-918	<b>TATA CONSULTING ENGINEERS LIMITED</b>	SECTION:WRITE-UP
	<b>Contractors Safety and Health programme</b>	SHEET 20 OF 23

ordinate with the EMPLOYER/CONSULTANT for liaising with government agencies, neighboring industries and community.

5.6) The Emergency Planning/Emergency Response shall be designed to allow people to work under disaster conditions when normal services such as telephone water, light power, transport and sanitation are not available and first aid and fire fighting facilities are not able to cope with sudden demand on services.

5.7) The Telephone numbers of Ambulance, Police, Fire , Hospitals/ medical centers, Managers and the Employers key executives shall be prominently displayed in the identified Emergency Response Centre.

**6.0) PREMISES AND HOUSE-KEEPING**

**6.1) ORDERLY WORK-PLACE**

CONTRACTOR shall maintain a well-managed safe working place in sound clean condition. The CONTRACTOR shall ensure that there is a place for everything and everything in its place so that optimum use is made of valuable floor space with commensurate cleanliness and reduced handling time. He shall ensure that his entire infrastructure including temporary and semi- temporary buildings are kept clean and good repair.

**6.2) GOOD LIGHTING-NATURAL AND ARTIFICIAL**

CONTRACTOR shall provide lighting natural or artificial to enable work Processes are carried out safely. Artificial lighting shall be adequate especially in the nights and emergencies. The lumen levels shall meet the statutory requirements.

**6.3) VENTILATION-NATURAL AND ARTIFICIAL**

CONTRACTOR shall ensure that workplaces are ventilated with at least prescribed amount of clean or cleaned fresh air of a suitable temperature, especially where toxic or irritating substances are present such as welding, vehicle exhaust fumes, irritating dusts, organic solvents or any other inimical atmosphere creating health hazards or safety.

**6.4) WELFARE AND HYGIENE FACILITIES**

CONTRACTOR shall provide Welfare facilities to ensure a high standard of cleanliness for all activities and rest. The CONTRACTOR shall provide facilities for his employees such as ablutions, toilets change rooms, kitchens and cafeterias adequate and in a clean and hygienic state.

**6.4.1) DRINKING WATER**

ISSUE R3
-------------

The Contractor shall make in every place where building or other construction work is in progress, effective arrangements to provide and maintain at suitable points conveniently situated for all persons employed therein, a sufficient supply of wholesome drinking water.

6.4.1.1) All such points shall be legibly marked "Drinking Water" in a language understood by a majority of the persons employed in such place and no such point shall be situated within six meters of any washing place, urinal or latrine.

6.4.1.2) Container used to distribute drinking water shall be hygienic and clearly marked as to the nature of its contents and not used for any other purpose.

**6.4.2) SANITATION ARRANGEMENTS.**

Latrines or urinals, as the case may be, required to be provided shall be of the types as specified below.

6.4.2.1) Every latrine shall be under cover and so partitioned off as to secure privacy, and shall have a door and fastenings;

6.4.2.2) Where both male and female building workers are employed there shall be displayed outside each block of latrine or urinals a notice containing therein " :

(i) For Men Only" or "For Women Only", as the case may be, written in the language understood by majority of such workers;

(ii) Such notice shall also bear the figure of a man or a woman, as the case may be.

(iii) Every latrine or urinal shall be conveniently situated and accessible to site workers at all the times;

(iv) Every latrine or urinal shall be adequately lighted and shall be maintained in a clean and sanitary condition at all the times;

(v) Every latrine or urinal other than those connected with a flush sewage System shall comply with the requirements of public health authorities.

(vi) Water shall be provided by means of a tap or otherwise so as to be conveniently accessible in or near latrine or urinal;

(vii) Wall, ceilings and partitions of every latrine or urinal shall be white washed or color washed once in every period of four months.

(viii) Hand soap or similar cleaning agent shall be provided in each latrine.

**6.4.2) CANTEENS:**

**6.4.2.1) CANTEENS AT LABOUR CAMPS:**

(i) In every place wherein not less than two hundred and fifty building workers are ordinarily employed, contractor of such building workers shall provide an adequate canteen.

(ii) The canteen shall consist of a dining hall with furniture sufficient to accommodate building workers using such canteen, a kitchen, and store

ISSUE

R3

SPEC.NO TCE.M4-918	<b>TATA CONSULTING ENGINEERS LIMITED</b>	SECTION:WRITE-UP
	<b>Contractors Safety and Health programme</b>	SHEET 22 OF 23

room, pantry and washing places separately for building workers and for utensils.

- (iii) The canteen shall be sufficiently lighted at all the times when any person has access to it.
- (iv) The floor of canteen shall be made of smooth and impervious material and inside the walls of such canteen shall be lime-washed or colour-washed at least once every six months.
- (v) The precincts of canteen shall be maintained in a clean and sanitary condition;
- (vi) Waste water from canteen shall be carried away in suitable covered drains and shall not be allowed to accumulate in the surrounding of such canteen.
- (vii) Suitable arrangements shall be made for collection and disposal of garbage from canteens.
- (viii) Building of canteen shall be situated at the distance not less than 15.2 metres from any latrine or urinal or any source of dust, smoke obnoxious fumes.
- (ix) Site where workers can not avail canteen facility due some reason and are need to take food close to work place, at such locations contractor shall provide a separate place for food serving facility with sound hygienic principles and shall meet the applicable laws.

**6.4.2.2 CANTEEN AT PROJECT PREMISES**

- (i) Workers must not cook in the project premises.
- (i) Workers shall carry the food from labour camps and shall have at designated lunch shed made by the contractor.
- (ii) Contractor should make shed for workers having lunch in designated location approved EMPLOYER/CONSULTANT.
- (iii) Workers having food in open / work location are strictly prohibited.

**6.4.3 SAFETY , HEALTH AND WELFARE AT LABOUR CAMPS**

- (i) The Contractor shall provide free of charge as near to it as may be possible, temporary living accommodation to all building workers employed by him for such period, as the building or other construction work is in progress.
- (ii) The temporary accommodation provided by the contractor shall have separate cooking place, Bathing, washing & lavatory facilities.
- (iii) As soon as may be, after the building or other construction work is over, the CONTRACTOR shall, at his own cost, cause removal or demolition of the temporary structures erected by him for purpose of providing living accommodation, cooking place or other facilities to the building workers and restore the ground in good level and clean condition.
- (iv) Colony/shelters constructed shall be situated at suitable heights where danger of water (waste or rainy) accumulation does not exists; as water accumulation ultimately leads to breeding ground for mosquitoes.
- (v) Shelters constructed at labour camp shall protect labourer/workers from rain,

cold and heat. And shall be so constructed, equipped and maintained, so far as

ISSUE
R3

reasonably practicable, as to prevent the entrance or harbour of rodent, insect, and other vermin. A continuing and effective extermination program shall be instituted where their presence is detected.

- (vi) Electric supply shall be provided at labour camps for illumination purpose.
- (vii) Safe and Adequate potable water shall be provided at camps. The quantity of water shall be decided after taking number of persons residing in camp into consideration.
- (viii) Proper access shall be provided to the shelters.
- (ix) Labourers residing at camp shall be encouraged to maintain their camp clean by providing waste bins and waste disposal system.
- (x) Facility shall be created to drain out waste water. Drainage of camps/colony shall be connected to drainage system or soak tanks to avoid water accumulation.
- (xi) Adequate toilets and washing facilities shall be provided for the labourers inside the camp.
- (xii) Safety & Health related posters shall be placed in the camp to increase safety and health awareness amongst the labourers.
- (xiii) First-aid facility shall be provided in the camp. Also few workers should be trained to render first-aid and fire fighting in case of emergencies.

**6.4 POLLUTION TO GROUND, AIR AND WATER**

- (i) The CONTRACTOR shall strive to exceed established minimum performance norms in waste and pollution control. All drains shall be identified as clean water and foul water to aid non-armful disposal. The CONTRACTOR shall ensure safe collection and disposal of solid, liquid and other waste, and ensure periodical cleaning of disposal bins, septic tanks and shall maintain the records.
- (ii) The CONTRACTOR shall have a System in place to segregate waste during construction and subsequent reuse or recycling.
- (iii) The CONTRACTOR shall take necessary measures to prevent construction activity pollution by controlling soil erosion and sedimentation as per the National Building Code (NBC) 2005 guidelines. The Top soil shall be staked and reused for land scaping, wherever applicable/ reused suitably.
- (iv) The CONTRACTOR shall take necessary measures to control dust generation at site and roads by sprinkling water at regular interval.
- (v) The CONTRACTOR shall conduct periodic ambient air quality monitoring through approved lab to check the pollution levels at the site particularly in areas where batching plant shall be maintained by the CONTRACTOR and produced to EMPLOYER/ CONSULTANT.

ISSUE  
R3

## **Section 6 – Employer's Requirements**

# **ADDENDUM TO SAFETY CONDITIONS FOR UNDERTAKING SITE WORK & CONTRACTOR'S SAFETY AND HEALTH PROGRAMME**

The Addendum mentioned hereunder is to be read in conjunction with the specification Spec. No. M4-918 - Issue-R2 for Contractors Safety and Health programme.

## Addendum

Spec. No. / Clause Details	Details of Clause as per Specification	Details of Amended Clause
<b>Contractors Safety and Health Programme</b>  <b>Spec. No. M4-918- Issue-R3</b>  <b>Clause No. 1.3 &amp; 1.3.1</b>	<p>1.3 SAFETY OFFICER</p> <p>1.3.1 SAFETY OFFICERS QUALIFICATION:</p> <p>A person shall not be eligible for appointment as Safety officer unless he</p> <p>(i) Possesses a recognized Degree in any branch of Engineering or Technology and had practical experience of working in industrial projects in a supervisory capacity for a period of not less than 3 years or possesses a recognized Diploma in any branch of engineering or technology and has had practical experience of working in industrial projects in a supervisory capacity for a period of not less than 5 year.</p> <p>(ii) Possesses a recognized degree or Advanced diploma in industrial safety. (Approved by the EMPLOYER/CONSULTANT on the basis of his adequate Safety qualification [Advanced Diploma in Industrial Safety approved by State Board of Technical Education] and his/her experience in safety field).</p> <p>(iii) Has adequate knowledge of the language spoken by majority of construction workers from the construction site in which he is deployed.</p>	<p>1.3 EHS OFFICER:</p> <p>The contractor shall designate a full-time Environment, Health and Safety (EHS) officer at the site. The EHS officer shall supervise, monitor and report on day-to-day compliance to requirements related to workers health and safety as specified in applicable laws, rules and regulations and EMP.</p> <p>1.3.1 EHS OFFICER'S QUALIFICATION:</p> <p>The EHS officer shall be qualified for this responsibility with either Diploma or degree in civil/ environmental engineering with minimum 5 years of experience in construction safety with knowledge of NEBOSH and OSHA and shall have the authority to issue instructions and take protective measures to prevent accidents. Throughout the execution of the Works, the Contractor shall provide whatever is required by this person to exercise this responsibility and authority.</p>